

**1200-Output Channel
TFT LCD Source Driver with TCON**

Specification
Preliminary

Version: V0.01
Document No.: ILI6137B_DS_V001.pdf

ILI TECHNOLOGY CORP.

8F., No.1, Taiyuan 2nd St., Zhubei City,
Hsinchu County 302, Taiwan (R.O.C.)
Tel.886-3-5600099; Fax.886-3-5670585
<http://www.ilitek.com>

Table of Contents

Section	Page
1. Introduction.....	3
2. Features	3
3. Block Diagram	4
3.1. Function Block Diagram	4
3.2. Application Block Diagram	5
3.2.1. 800(RGB) x 480 (Gate driver on left side).....	5
3.2.2. 800(RGB) x 600 (Gate driver on left side).....	6
3.2.3. 800(RGB) x 480 (Gate driver on right side).....	7
3.2.4. 800(RGB) x 600 (Gate driver on right side).....	8
4. Pin Descriptions	9
5. Operation Description	13
5.1. Relationship between input data and output channels	13
5.1.1. Stripe Mode	13
5.2. Dot Polarity Inversion	14
5.3. Gate Scan Sequence	15
5.4. Application Block Diagram	17
5.5. Display Data Input Timing	20
5.5.1. Vertical Input Timing	20
5.5.2. Horizontal Input Timing	20
5.5.2.1. SYNC Mode (MODE="L").....	20
5.5.2.2. DE Mode (MODE="H")	20
5.6. Relationship between gamma correction and output voltage	22
5.7. Power ON/OFF Sequence	24
5.8. Standby ON/OFF Control	25
5.9. The BIST Patterns for Aging Mode Test.....	26
5.11. The Command Format for 3-line Serial Interface.....	27
6. DC Characteristic	28
6.1. Absolute Maximum Rating (VSS = VSSA=0V, Ta=25°C).....	28
6.2. DC Electrical Characteristics (VSS=VSSA=0V, Ta=25°C)	28
7. AC Characteristics	29
7.1. AC Timing characteristics.....	29
7.2. Display Timing characteristics.....	33
7.2.1. Resolution: 800x480.....	33
7.2.2. Resolution: 800x600.....	35
8. Pad Sequence (Bump Side).....	36
9. Pad Arrangement and Coordination.....	37
10. Revision History	45

1. Introduction

ILI6137B is a 1200-channel output source driver with TTL interface timing controller (TCON). The interface follows digital 24-bit parallel RGB input format. The TCON generates the 800x480 and 800x600 resolutions and provides horizontal and vertical control timing to source driver and gate driver. It also supports dithering feature, apply source driver with 6-bit DAC to perform 8-bit resolution 256 gray scales. Operating parameters can be set via pin control for all control features. Since the output circuit of this source driver incorporates an operational amplifier with low power dissipation, and performs wide voltage supply range and small output deviation.

ILI6137B can be configured as dual-gate operation mode for reducing FPC amount and saving the cost. With wide range of supply voltages and many pin control features make this chip mode suitable for various applications.

2. Features

◆ TCON

- Supports display resolution 800x480 and 800x600
- Supports digital 24-bit parallel RGB input mode
- Source output with 8-bit resolution for 256 gray scales (2-bit dithering)
- Supports dual-gate operation mode
- Supports Stripe CF configuration
- Maximum Operation frequency: 50 MHz
- Provide flip and mirror scan mode by pin control
- Supports stand-by mode for saving power consumption
- Operation Voltage Level 3.0V to 3.6V

◆ Source Driver

- 1200 channels output source driver for TFT LCD panel
- Embedded custom-made Gamma table for special custom request
- Supports external V1~V14 pad for Gamma adjustment
- Output dynamic range: 0.1 ~ VDDA-0.1V
- Voltage deviation of outputs: $\pm 20\text{mV}$
- Power for source driver voltage (VDDA) : 8.5V ~ 13.5V

◆ Others

- COG package

3. Block Diagram

3.1. Function Block Diagram

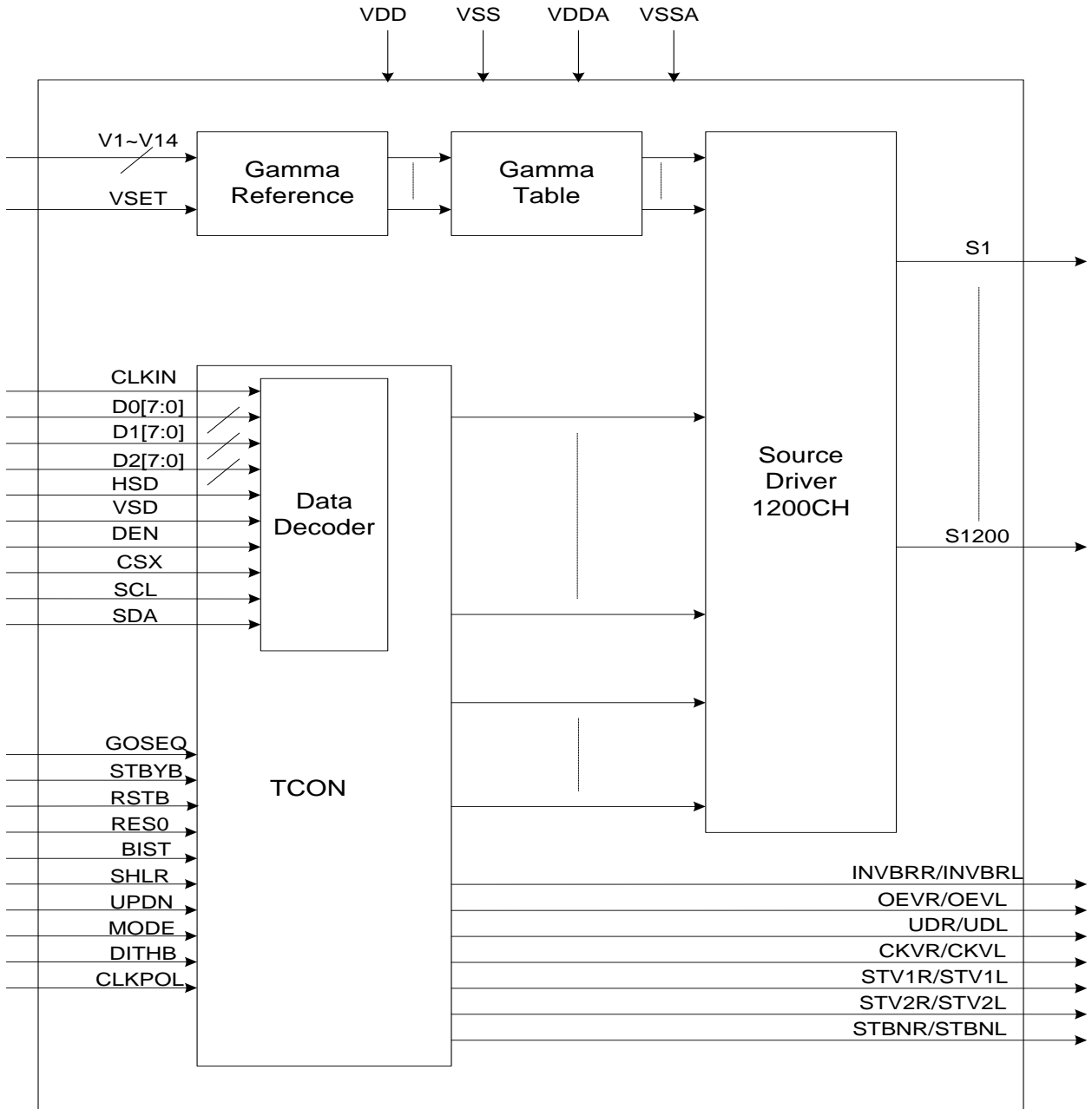

3.2. Application Block Diagram

3.2.1. 800(RGB) x 480 (Gate driver on left side)

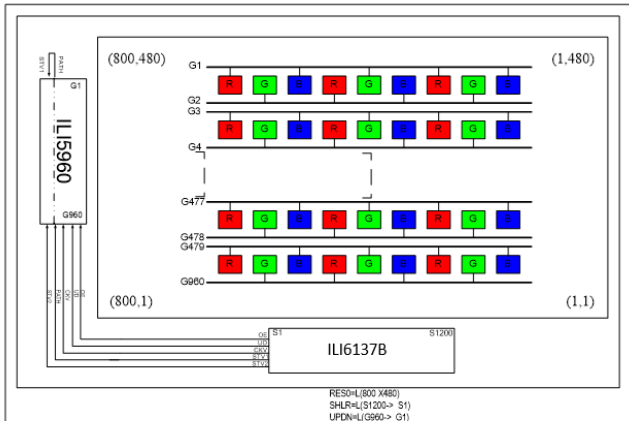
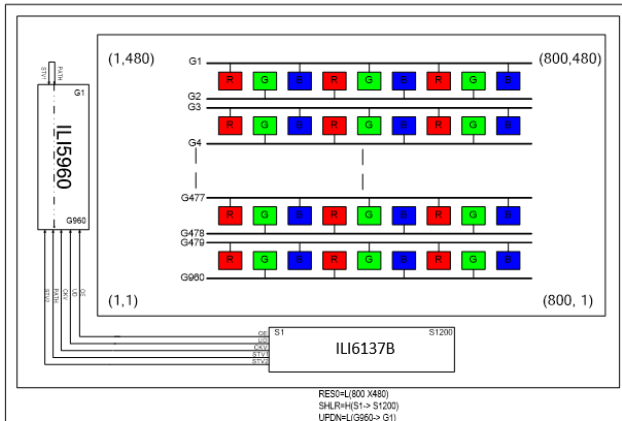
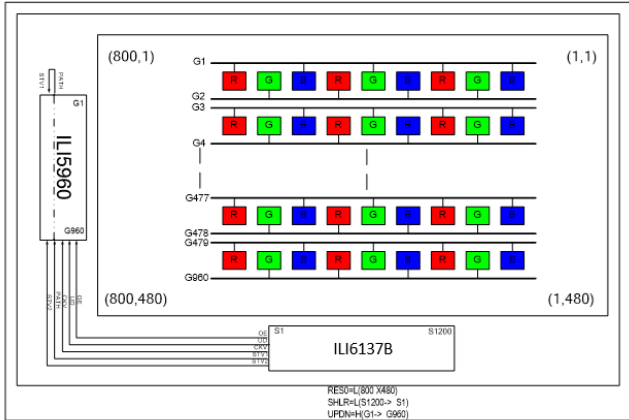
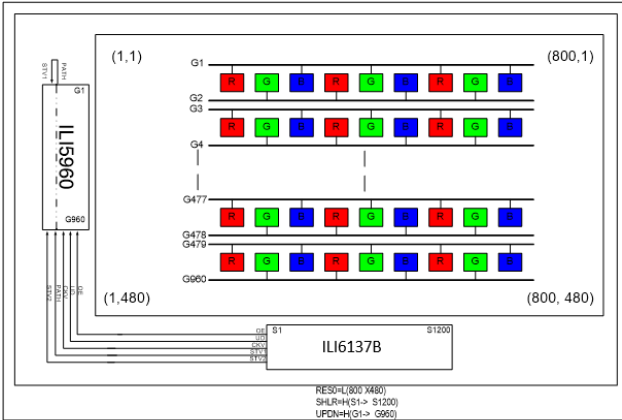

3.2.2. 800(RGB) x 600 (Gate driver on left side)

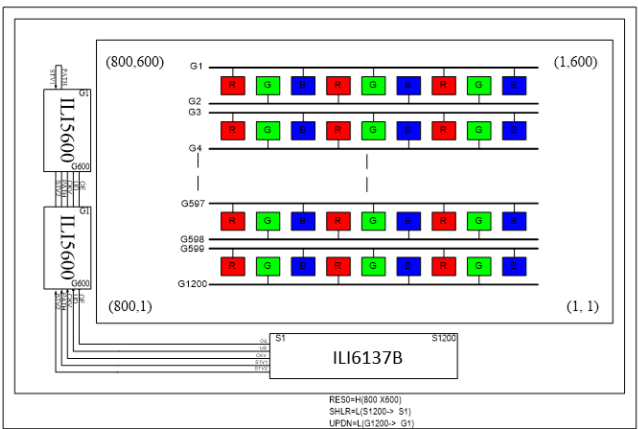
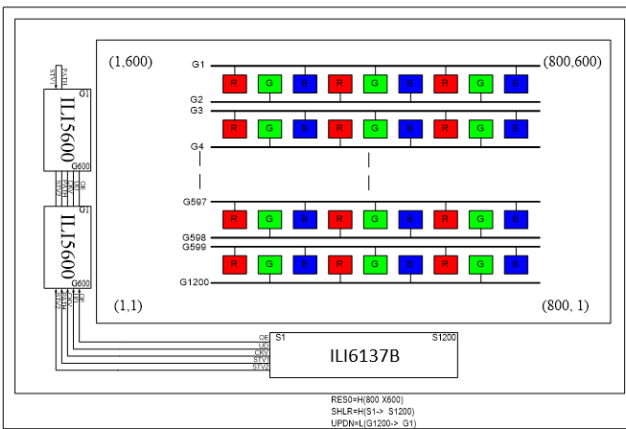
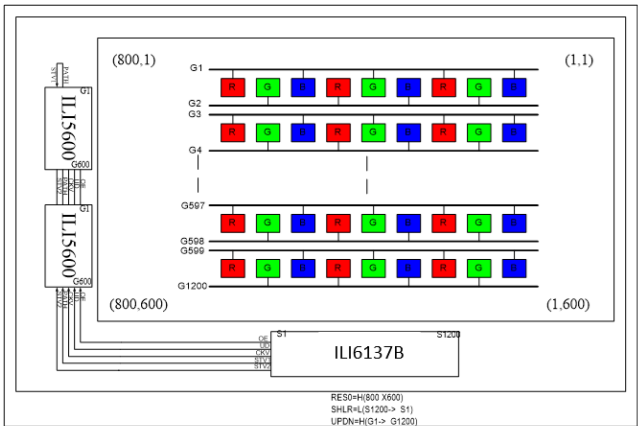
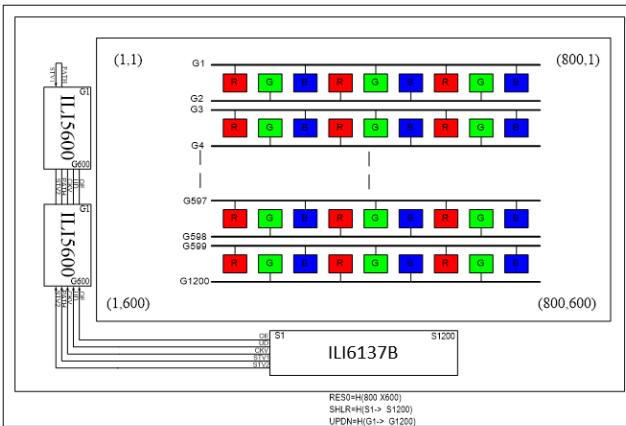

3.2.3. 800(RGB) x 480 (Gate driver on right side)

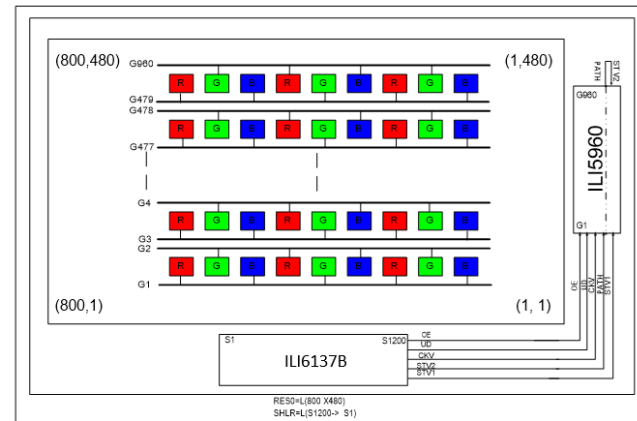
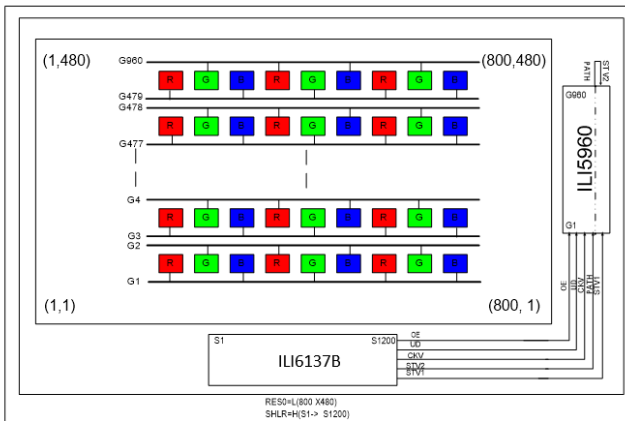
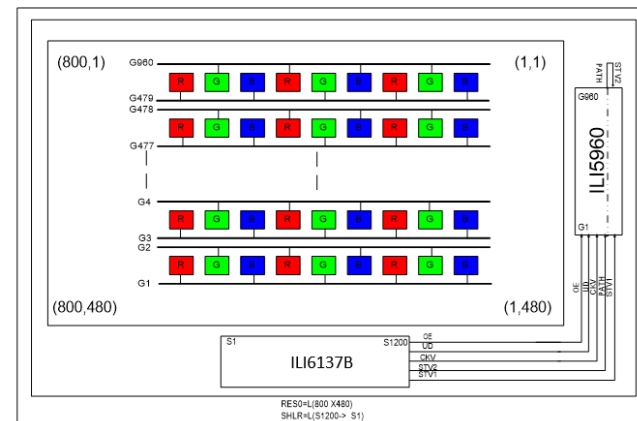
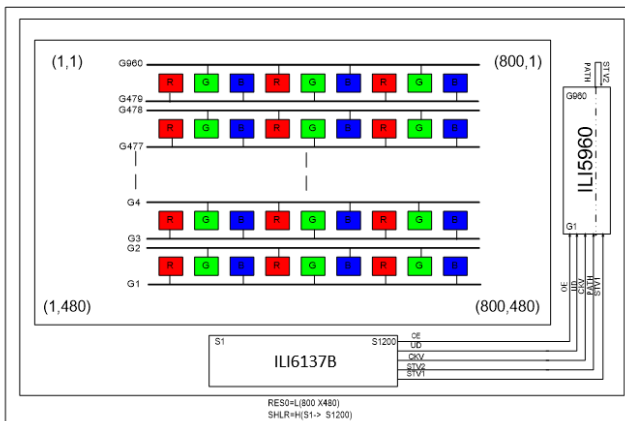
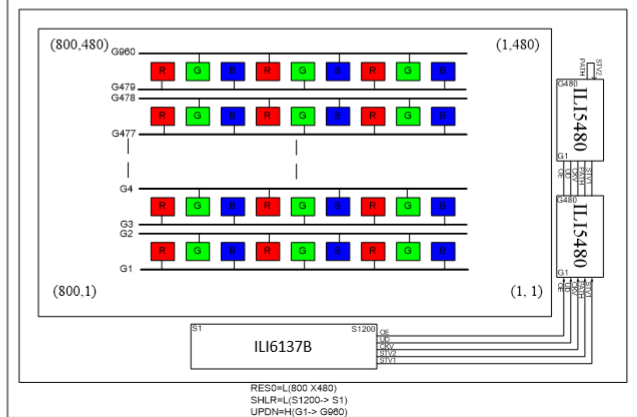
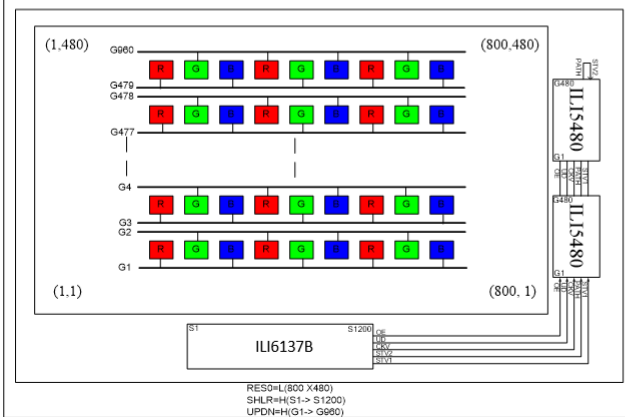
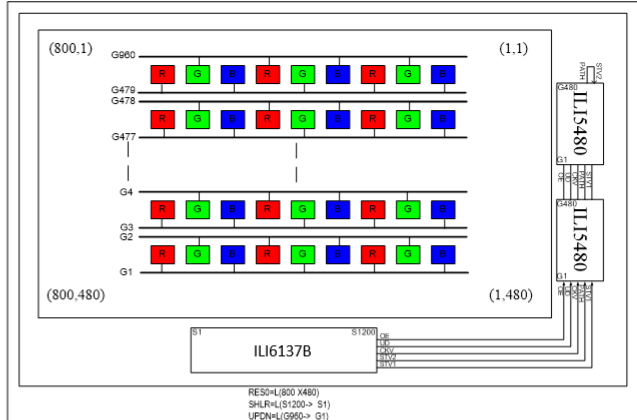
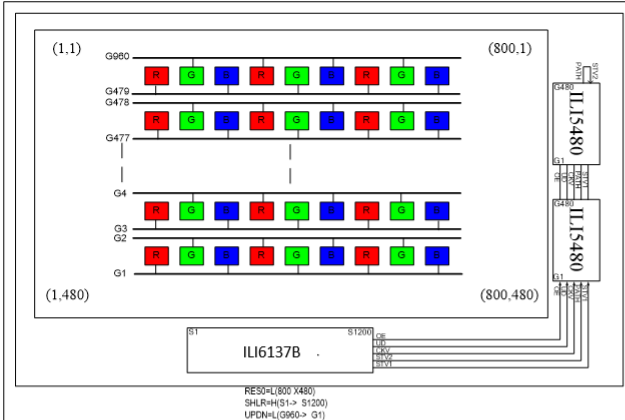

3.2.4. 800(RGB) x 600 (Gate driver on right side)

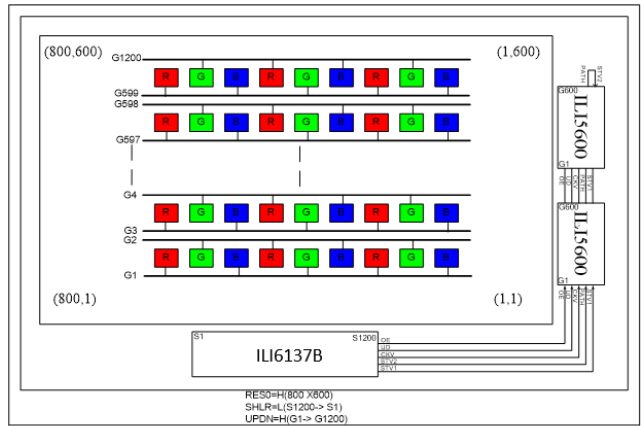
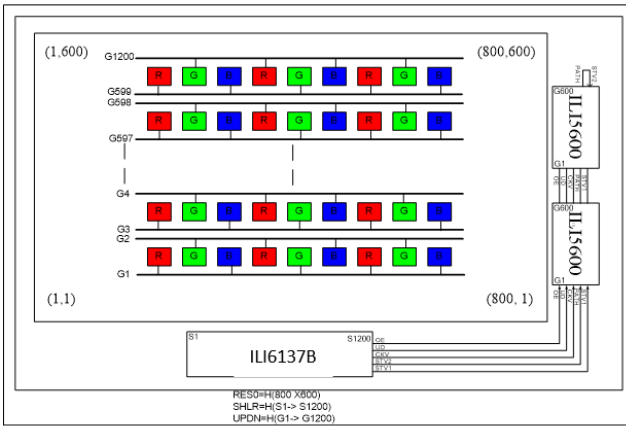
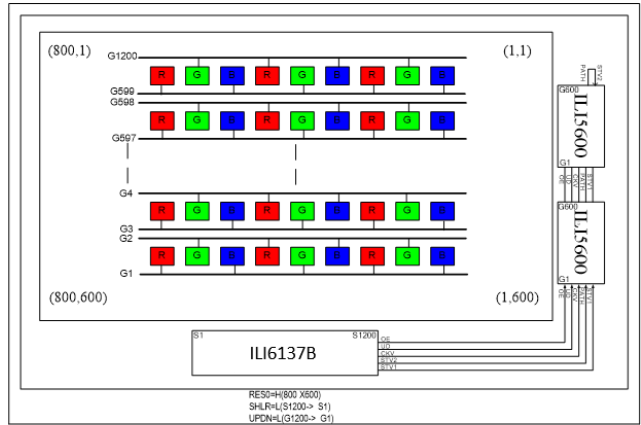
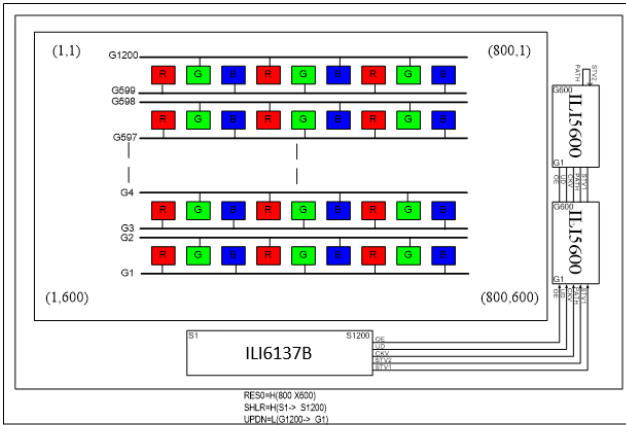

4. Pin Descriptions

Pin Name	I/O	Descriptions
CLKIN	I	Clock for input data. Data latched at rising/falling edge of this signal. Default is falling edge.
D0[7:0] D1[7:0] D2[7:0]	I	Digital data input. Dx0 is LSB and Dx7 is MSB. D0[7:0] = R[7:0] data; D1[7:0] = G[7:0] data; D2[7:0]=B[7:0] data. When 18-bit RGB interface (disable dithering function), please use Dx[7:2] as 6-bit input and connect Dx[1:0] to VSS.
HSD	I	Horizontal sync input in digital parallel RGB. Negative polarity.
VSD	I	Vertical sync input in digital parallel RGB. Negative polarity.
DEN	I	Input data enable control. When DE mode, active High to enable data input. (Normally pull low)
MODE	I	DE / SYNC mode select. (Normally pull high) MODE="L", for entering SYNC mode. MODE="H", for entering DE mode.
CSX	I	Reserved pins, not accessible to user. (Normally pull high)
SCL	I	Reserved pins, not accessible to user. (Normally pull high)
SDA	I/O	Reserved pins, not accessible to user. (Normally pull high)
RSTB	I	Hardware global reset. Low active. (Normally pull high)
RES0	I	Display resolution selection. (Normally pull low) RES0="L", for 800(RGB)x480 display resolution. RES0="H", for 800(RGB)x600 display resolution.
DITHB	I	Dithering function enable control. (Normally pull high) DITHB="L", to enable internal dithering function. DITHB="H", to disable internal dithering function.
CLKPOL	I	Input clock edge selection. (Normally pull low) CLKPOL="L", latch data at CLKIN falling edge. CLKPOL="H", latch data at CLKIN rising edge.
V1 ~ V14	I/O	When VSET="L", the internal Gamma table is used and V1~V14 pins are unused. When VSET="H", V1~V14 pins are the external adjustment point for Gamma correction. The relationship between V1~V14 must be : VSSA<V14<V13<V12<V11<V10<V9<V8<V7<V6<V5<V4<V3<V2<V1<VDDA
GOSEQ	I	Gate on sequence. (Normally pull low) GOSEQ="L", INVBRR/INVBRL will output "H" and gate on sequence is "G1→G2→G3→G4→G5→G6→G7→G8→.....→G _{n-3} →G _{n-2} →G _{n-1} →G _n "

Pin Name	I/O	Descriptions
		GOSEQ="H", INVBRR/INVBRL will output "L" and gate on sequence is "G1→G2→G4→G3→G5→G6→G8→G7→.....→G _{n-3} →G _{n-2} →G _n →G _{n-1} "
VSET	I	Gamma correction source select. (Normally pull low) VSET="L", to use internal Gamma reference voltage (VDDA). VSET="H", to use external Gamma correction input (V1~V14).
STBYB	I	Standby mode control. (Normally pull high) STBYB="L", enter standby mode for power saving. Timing controller and source driver will turn off, all outputs are Hi-Z. STBYB="H", normal operation.
SHLR	I	Source shift direction control. (Normally pull high) SHLR="L", shift direction is "S1200 → S1199 → 1198 → ... S3 → S2 → S1" SHLR="H", shift direction is "S1 → S2 → S3 → ... → S1198 → S1199 → S1200".
UPDN	I	Gate scan direction control (Normally pull low) UPDN="L", STV2 outputs the vertical start pulse and UD pin outputs "L" to Gate driver. UPDN="H", STV1 outputs the vertical start pulse and UD pin outputs "H" to Gate driver.
BIST	I	Normal operation / BIST pattern select. (Normally pull low) BIST="L", Normal operation BIST="H", BIST (DCLK input is not needed)
BLKEN	O	The backlight control signal for external backlight controller. BLKEN="L", turn off the external backlight controller. BLKEN="H", turn on the external backlight controller.
OEVR OEVL	O	Gate driver control signal.
UDR UDL	O	Gate driver control signal.
CKVR CKVL	O	Gate driver control signal.
STV1R STV1L	O	Gate driver control signal.
STV2R STV2L	O	Gate driver control signal.
STBNR STBNL	O	Gate driver control signal.
INVBRR INVBRL	O	Gate driver control signal.

Pin Name	I/O	Descriptions
VDDA	P	Power supply for analog block.
VSSA	P	Ground level for analog block.
VDD	P	Power supply for digital block.
VSS	P	Ground level for digital block.
S1 ~ S1200	O	Source driver output signals.
ALIGN	--	For assembly alignment.
COM1_B COM2_B	--	COM1_B and COM2_B are short-circuited within ILI6137B for contact resistance measurement. Please leave it open when not in use.
COM1_T COM2_T	--	COM1_T and COM2_T are short-circuited within ILI6137B for contact resistance measurement. Please leave it open when not in use.
TP0 ~ TP4	I	Test pins, not accessible to user.
TP5	I	TP5 pin: Normal black/Normal white data reversed pin. HIGH- Normal black , LOW- Normal white
TP6 ~ TP10	O	Test pins, not accessible to user.
SHIELDING	--	IC shielding pads. Those pins are internally connected to VSSA level.
TN0, TN1, TN8, TN9	-	Reserved pins, not accessible to user.
TN2 ~ TN5, TN7	I	Reserved pins, not accessible to user.
DASHD	--	Data bus shielding pad. Those pins are internally connected to VSS level.
DUMMY	--	Dummy pads. Please leave it open when not in use.

Note: (1) Please power on following the sequence VDD → logic input → VDDA and V1 ~ V14. Reverse the sequence to shut down.

(2) To stabilize the supply voltages, please be sure to insert a 0.1uF bypass capacitor between VDD↔VSS and VDDA↔VSSA. Furthermore, for increased precision of the D/A converter, insertion of a bypass capacitor of about 0.01uF is also advised between the gamma-corrected power supply terminals (V1, V2, ..., V14) and VSSA.

(3) Please keep V1~V14 not cross to the toggle signals as possible to avoid the AC coupling on the DC V1~V14 voltage. When used as cascade mode, please keep the coupled amount of V1~V10 are the same between the two chips.

(4) The input wiring resistance values affect power or signal integrity and the display quality. So be sure to design using values that do not exceed those recommended as below.

Pin Name	Wiring resistance value(Ω)
VDDA	< 5
VSSA	< 5
VDD	< 10
VSS	< 10
V1 ~ V14	< 10
Dx[0:7]	< 50
CLKIN	< 50
VSD	< 50
HSD	< 50
DEN	< 50
BLKEN	< 200
CSX	< 200
SCL	< 200
SDA	< 200
RSTB	< 500
STBYB	< 500
DITHB	< 500
SHLR	< 500
UPDN	< 500
BIST	< 500
MODE	< 500
RES0	< 500
CLKPOL	< 500
VSET	< 500
INVBRR / INVBRL	< 500
OEVR / OEVL	< 500
UDR / UDL	< 500
CKVR / CKVL	< 500
STV1R / STV1L	< 500
STV2R / STV2L	< 500
STV2R / STV2L	< 500
STBNR / STBNL	< 500
Others	< 500

5. Operation Description

5.1. Relationship between input data and output channels

5.1.1. Stripe Mode

The relationship between input display data and source output channels is illustrated as below:

SHLR="L", Left Shift Direction							
Output	S1	S2	S3	←	S1198	S1199	S1200
Order	Last data			---	First data		
Odd Line / G _n	D0[7:0]	D2[7:0]	D1[7:0]	---	D0[7:0]	D2[7:0]	D1[7:0]
Odd Line / G _{n+1}	D1[7:0]	D0[7:0]	D2[7:0]	---	D1[7:0]	D0[7:0]	D2[7:0]
Even Line / G _n	D0[7:0]	D2[7:0]	D1[7:0]	---	D0[7:0]	D2[7:0]	D1[7:0]
Even Line / G _{n+1}	D1[7:0]	D0[7:0]	D2[7:0]	---	D1[7:0]	D0[7:0]	D2[7:0]

SHLR="H", Right Shift Direction							
Output	S1	S2	S3	→	S1198	S1199	S1200
Order	First data			---	Last data		
Odd Line / G _n	D0[7:0]	D2[7:0]	D1[7:0]	---	D0[7:0]	D2[7:0]	D1[7:0]
Odd Line / G _{n+1}	D1[7:0]	D0[7:0]	D2[7:0]	---	D1[7:0]	D0[7:0]	D2[7:0]
Even Line / G _n	D0[7:0]	D2[7:0]	D1[7:0]	---	D0[7:0]	D2[7:0]	D1[7:0]
Even Line / G _{n+1}	D1[7:0]	D0[7:0]	D2[7:0]	---	D1[7:0]	D0[7:0]	D2[7:0]

5.2. Dot Polarity Inversion

ILI6137B supplies 1+2-dot inversion, the pixel polarity inversion was illustrated as below:

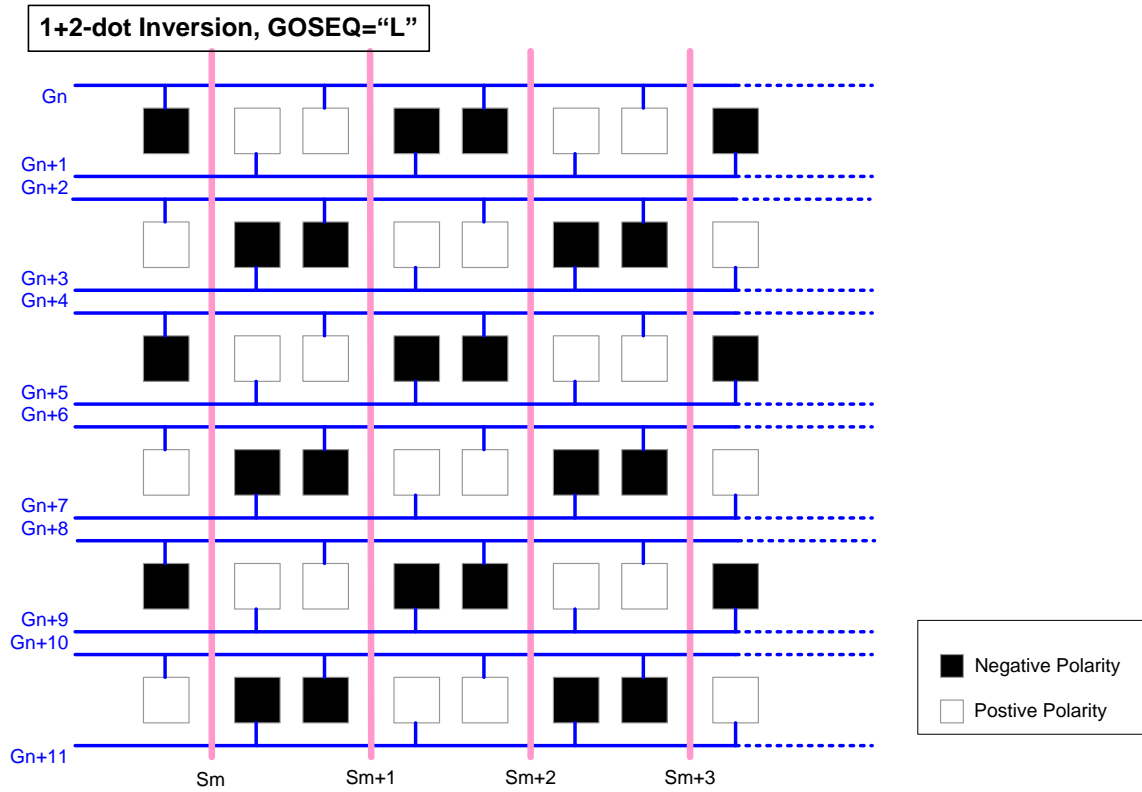

5.3. Gate Scan Sequence

Based on special panel request, ILI6137B supports two kinds of gate scan sequences and illustrated as below:

GOSEQ="L", UPDN="H" → INVBRR/INVBRL="H" (Traditional Scan, For General Gate Driver)

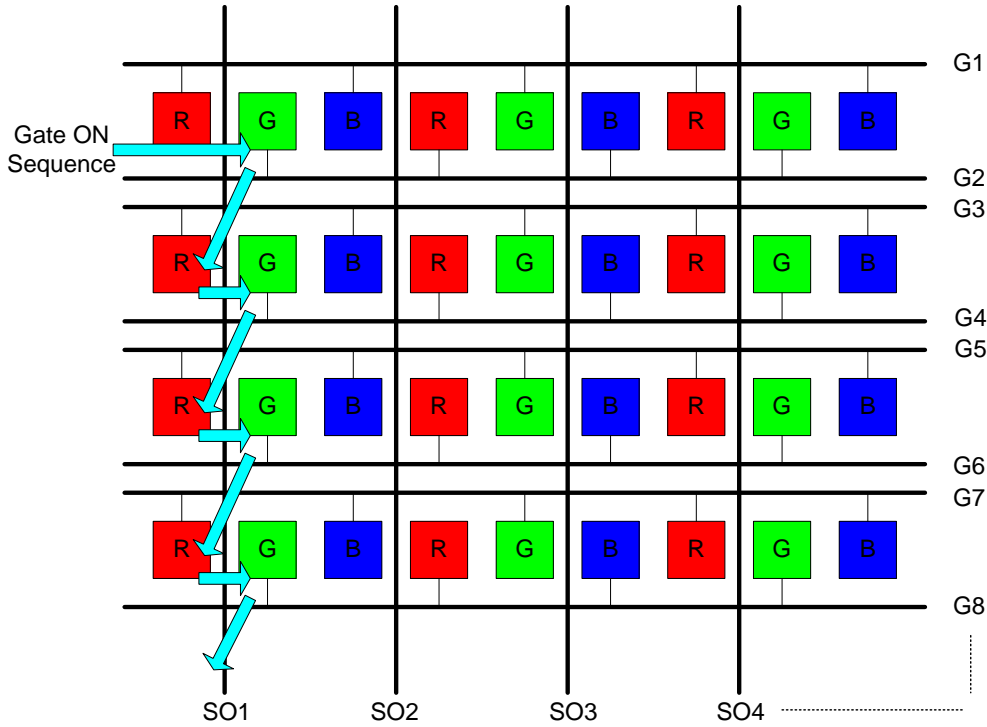

GOSEQ="H", UPDN="H" → INVBRR/INVBRL="L" (Bow-shaped Scan, For Special Gate Driver)

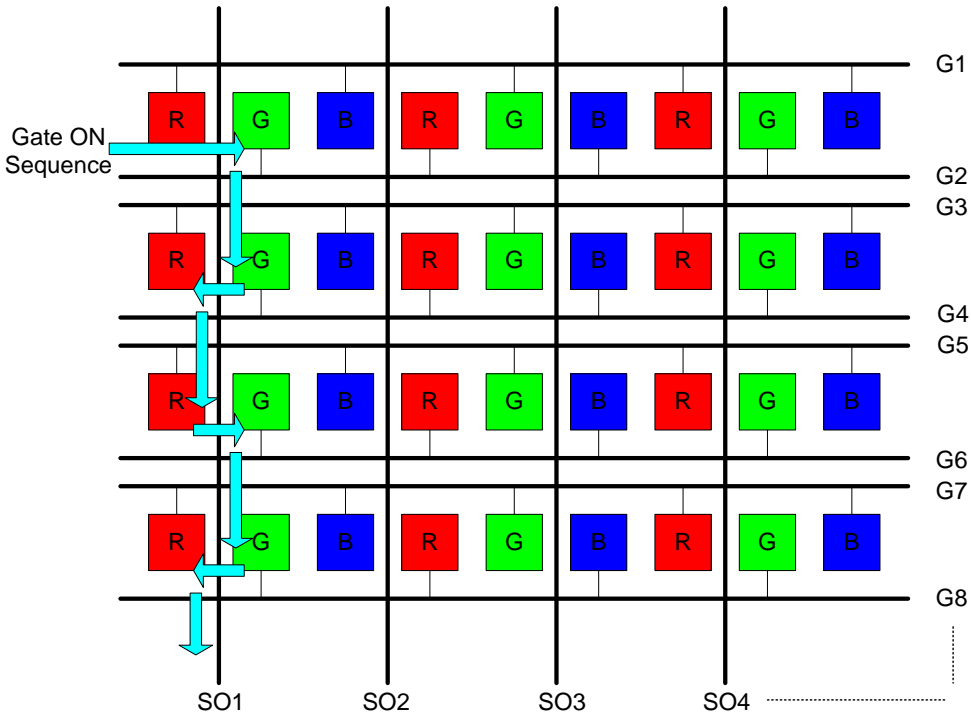

GOSEQ="L", UPDN="L" → INVBRR/INVBRL="H" (Traditional Scan, For General Gate Driver)

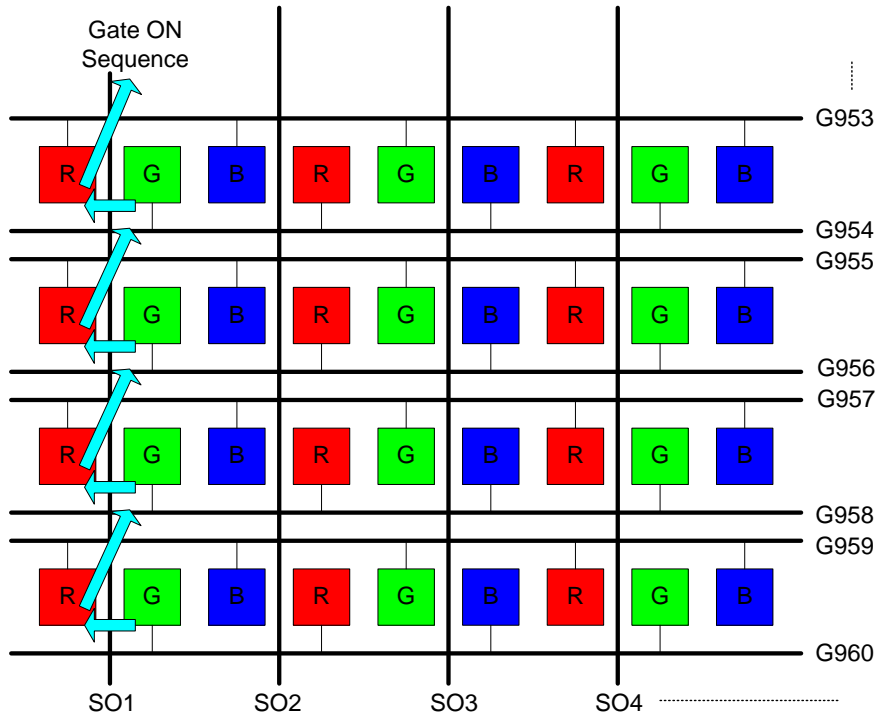

GOSEQ="H", UPDN="L" → INVBRR/INVBRL="L" (Bow-shaped Scan, For Special Gate Driver)

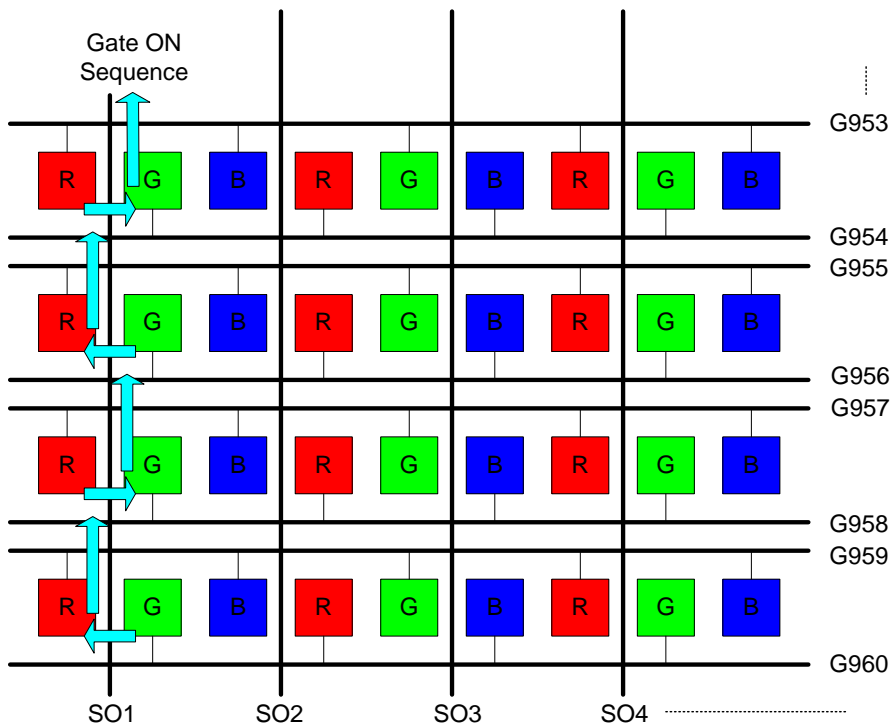

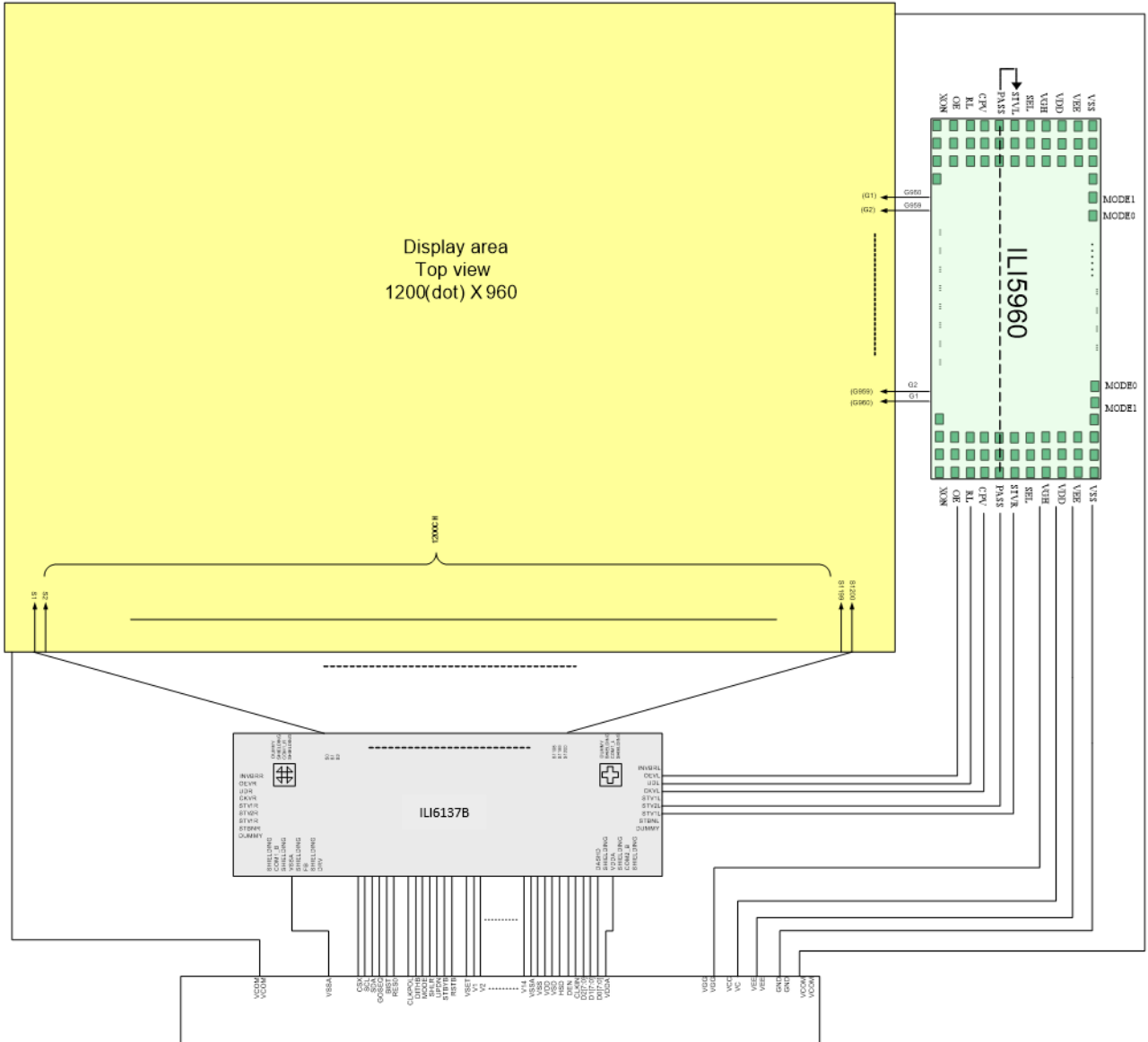

The configuration examples 800(RGB)*600 of the ILI6137B are illustrated as the following figure.

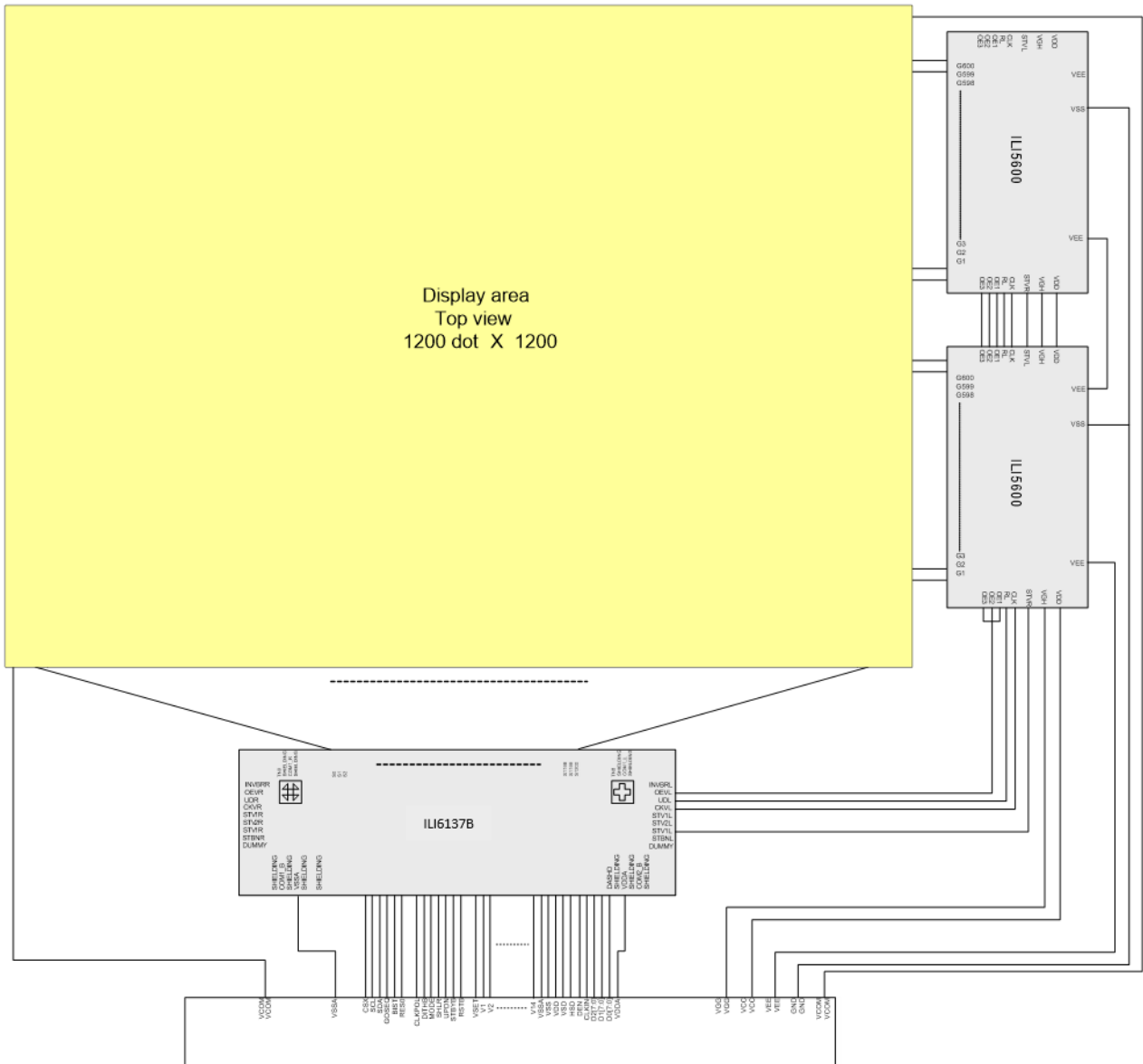

5.5. Display Data Input Timing

5.5.1. Vertical Input Timing

ILI6137B provides two different interface modes, SYNC mode and DE mode. Both modes can be selected by MODE pin, ILI6137B will enter the SYNC mode while MODE pin is set to 'L' and enter DE mode while MODE pin is set to 'H'.

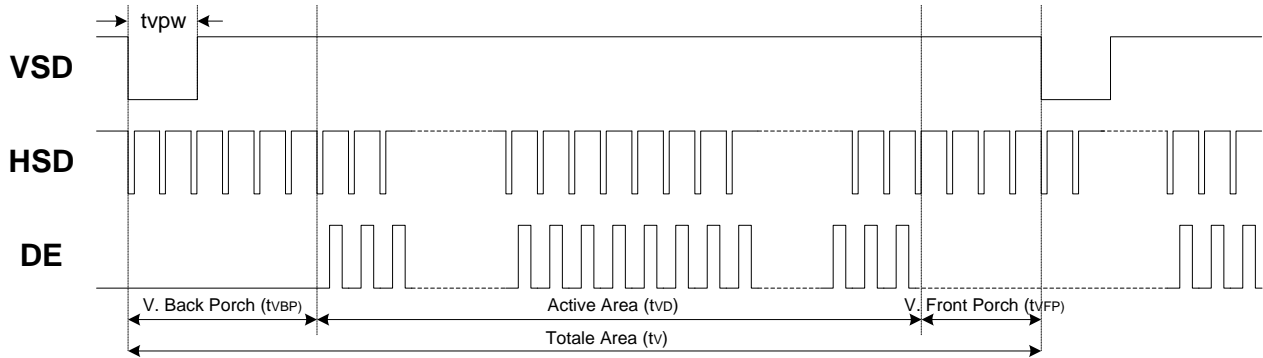

5.5.2. Horizontal Input Timing

5.5.2.1. SYNC Mode (MODE="L")

ILI6137B will enter SYNC mode while MODE pin is fixed at "L" level. Every HSD period is consists of Horizontal Back Porch, Active Area and Horizontal Front Porch time. The first active display data is transmitted at the first falling/rising edge of CLKIN after Horizontal Back Porch period and the last display data is transmitted at the last falling/rising edge of CLKIN before Horizontal Front Porch period.

5.5.2.2. DE Mode (MODE="H")

ILI6137B will enter DE mode while MODE pin is fixed at "H" level. ILI6137B will treat the data on Dx[7:0] bus as active display data while DEN is at "H" level and ignore the data on Dx[7:0] bus while DEN is at "L" level.

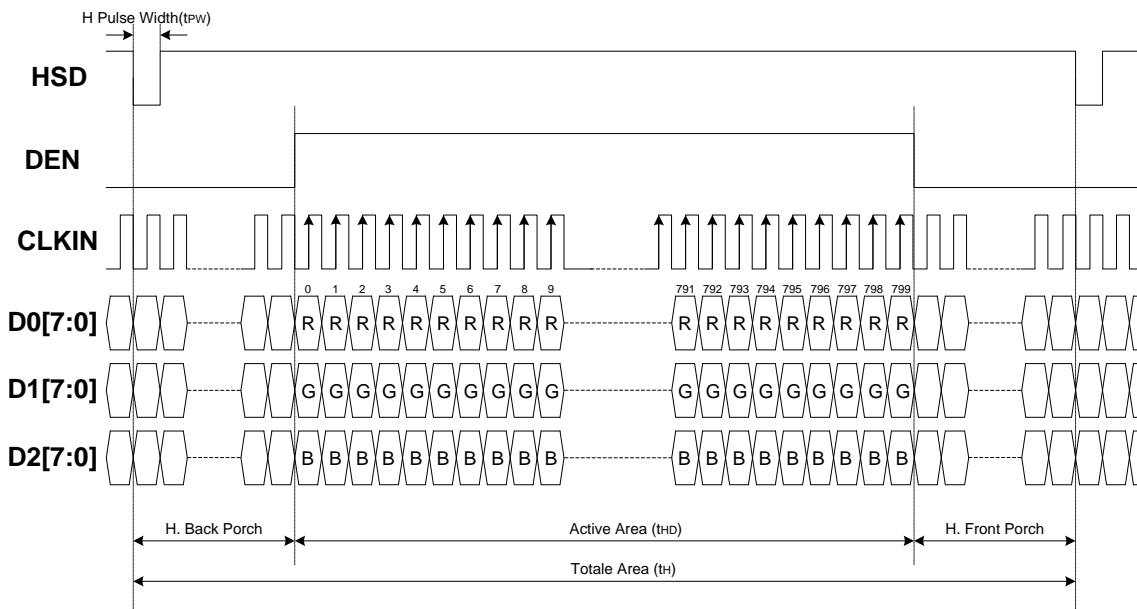

ILI6137B will latch the display data on Dx[7:0] bus at falling edge of CLKIN when CLKPOL is set to “L”, the input data timing is illustrated as below:

CLKPOL= “L”

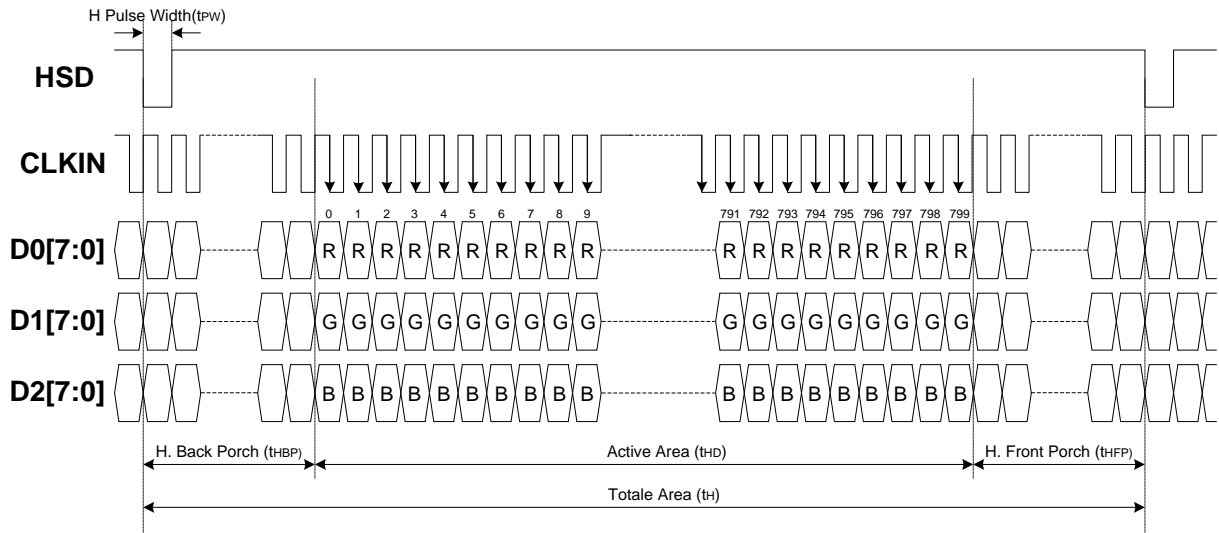

ILI6137B will latch the display data on Dx[7:0] bus at rising edge of CLKIN when CLKPOL is set to “H”, the input data timing is illustrated as below:

CLKPOL= “H”

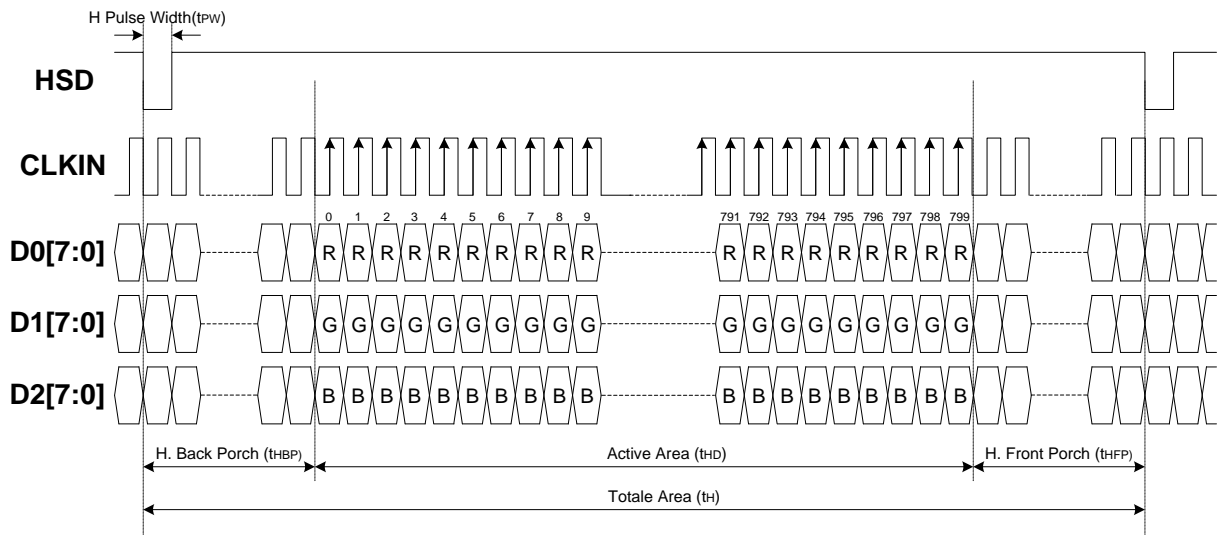

5.6. Relationship between gamma correction and output voltage

The output voltage is determined by the 6-bit digital input data, and the V1 ~ V14 gamma correction reference voltage inputs. The figure in the following shows the relationship between the input data and the output voltage. Refer the next page for the relative values and voltage calculation method.

Gamma correction characteristic curve:

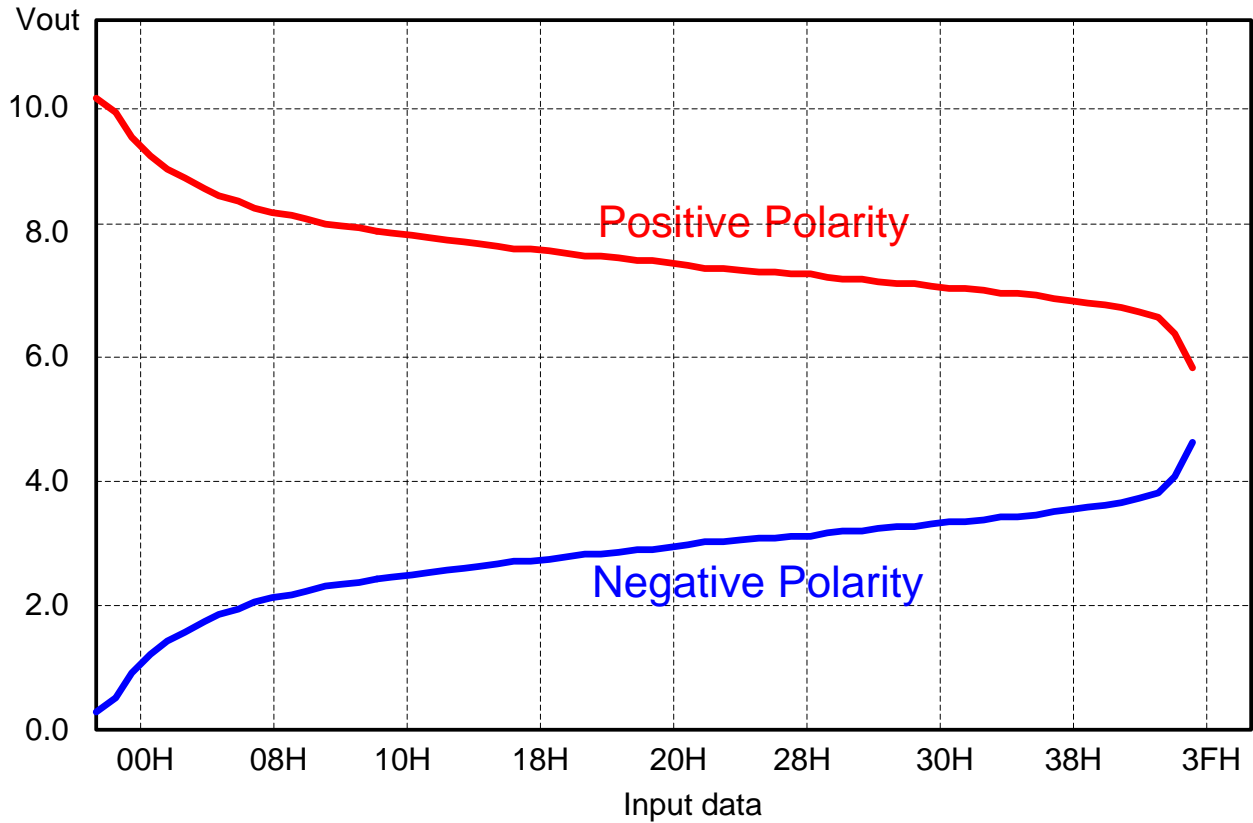

Note : $VDDA-0.1 \geq V1 \geq V2 \geq V3 \geq V4 \geq V5 \geq V6 \geq V7 \geq V8 \geq V9 \geq V10 \geq V11 \geq V12 \geq V13 \geq V14 \geq VSSA+0.1$

The internal Gamma Table is shown as below. (VSET="L")

Display Data (Hex)	Positive Polarity	Negative Polarity
00h	VDDA x 0.961	VDDA x 0.019
01h	VDDA x 0.937	VDDA x 0.045
02h	VDDA x 0.903	VDDA x 0.081
03h	VDDA x 0.880	VDDA x 0.106
04h	VDDA x 0.861	VDDA x 0.126
05h	VDDA x 0.847	VDDA x 0.142
06h	VDDA x 0.836	VDDA x 0.155
07h	VDDA x 0.826	VDDA x 0.166
08h	VDDA x 0.818	VDDA x 0.176
09h	VDDA x 0.810	VDDA x 0.184
0Ah	VDDA x 0.804	VDDA x 0.192
0Bh	VDDA x 0.798	VDDA x 0.199
0Ch	VDDA x 0.793	VDDA x 0.205
0Dh	VDDA x 0.788	VDDA x 0.211
0Eh	VDDA x 0.783	VDDA x 0.217
0Fh	VDDA x 0.779	VDDA x 0.222
10h	VDDA x 0.775	VDDA x 0.227
11h	VDDA x 0.772	VDDA x 0.231
12h	VDDA x 0.768	VDDA x 0.236
13h	VDDA x 0.765	VDDA x 0.240
14h	VDDA x 0.762	VDDA x 0.244
15h	VDDA x 0.759	VDDA x 0.248
16h	VDDA x 0.757	VDDA x 0.252
17h	VDDA x 0.754	VDDA x 0.256
18h	VDDA x 0.751	VDDA x 0.259
19h	VDDA x 0.749	VDDA x 0.263
1Ah	VDDA x 0.746	VDDA x 0.266
1Bh	VDDA x 0.744	VDDA x 0.269
1Ch	VDDA x 0.742	VDDA x 0.272
1Dh	VDDA x 0.740	VDDA x 0.276
1Eh	VDDA x 0.737	VDDA x 0.279
1Fh	VDDA x 0.735	VDDA x 0.282
20h	VDDA x 0.733	VDDA x 0.285
21h	VDDA x 0.731	VDDA x 0.288
22h	VDDA x 0.729	VDDA x 0.291
23h	VDDA x 0.728	VDDA x 0.294
24h	VDDA x 0.726	VDDA x 0.297
25h	VDDA x 0.724	VDDA x 0.300
26h	VDDA x 0.721	VDDA x 0.302
27h	VDDA x 0.719	VDDA x 0.305
28h	VDDA x 0.717	VDDA x 0.308
29h	VDDA x 0.716	VDDA x 0.311
2Ah	VDDA x 0.714	VDDA x 0.315
2Bh	VDDA x 0.713	VDDA x 0.318
2Ch	VDDA x 0.712	VDDA x 0.321
2Dh	VDDA x 0.710	VDDA x 0.325
2Eh	VDDA x 0.708	VDDA x 0.328
2Fh	VDDA x 0.707	VDDA x 0.331
30h	VDDA x 0.704	VDDA x 0.334
31h	VDDA x 0.702	VDDA x 0.337
32h	VDDA x 0.700	VDDA x 0.340
33h	VDDA x 0.698	VDDA x 0.344
34h	VDDA x 0.697	VDDA x 0.349
35h	VDDA x 0.695	VDDA x 0.353
36h	VDDA x 0.693	VDDA x 0.358
37h	VDDA x 0.692	VDDA x 0.363
38h	VDDA x 0.690	VDDA x 0.368
39h	VDDA x 0.688	VDDA x 0.374
3Ah	VDDA x 0.686	VDDA x 0.381
3Bh	VDDA x 0.683	VDDA x 0.389
3Ch	VDDA x 0.680	VDDA x 0.398
3Dh	VDDA x 0.675	VDDA x 0.408
3Eh	VDDA x 0.664	VDDA x 0.423
3Fh	VDDA x 0.604	VDDA x 0.489

VDDA=10.4V		
V _{GMA}	Code	Voltage
V1	00h	9.99 V
V2	01h	9.74 V
V3	10h	8.06 V
V4	20h	7.62 V
V5	30h	7.32 V
V6	3Eh	6.91 V
V7	3Fh	6.28 V
V8	3Fh	5.09 V
V9	3Eh	4.40 V
V10	30h	3.47 V
V11	20h	2.96 V
V12	10h	2.36 V
V13	01h	0.47 V
V14	00h	0.198 V

5.7. Power ON/OFF Sequence

To prevent the device damage from latch up, the power ON/OFF sequence shown below must be followed.

Power ON: VDD, VSS → VDDA, VSSA → V1 to V14

Power OFF: V1 to V14 → VDDA, VSSA → VDD, VSS

In order to prevent ILI6137B from power ON reset fail, the rising time (t_{POR}) of the digital power supply VDD should be maintained within given specifications. The power ON/OFF timing sequence is illustrated as below:

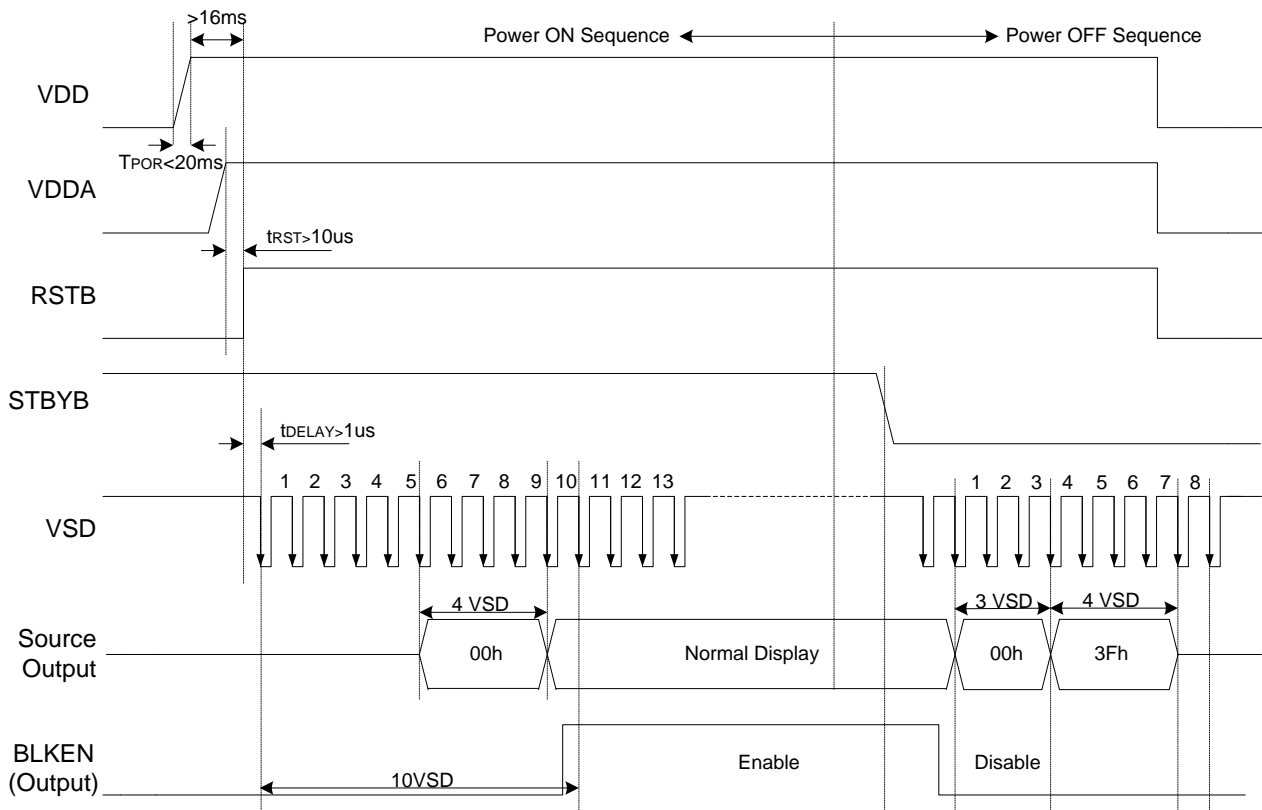

Note: For preventing abnormal operation, t_{RST} must be longer than 10us during Power ON sequence.



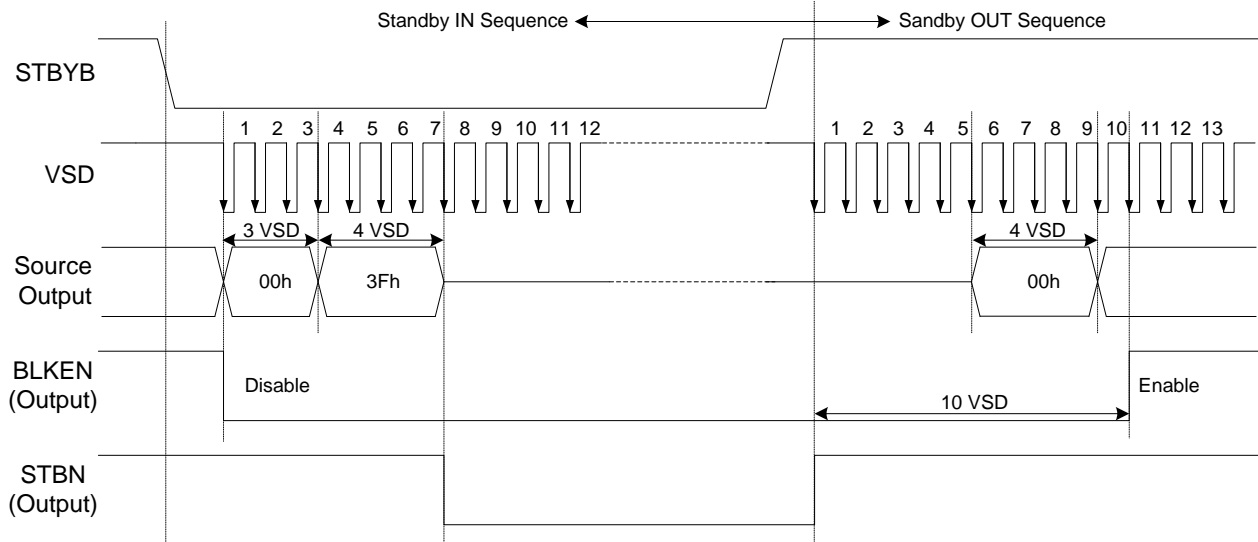

5.8. Standby ON/OFF Control

ILI6137B supports Standby mode for saving power consumption, the source driver will turn off and all source output channel will be Hi-Z state when chip in Standby mode. The Standby mode can be controlled via STBYB pin and the Standby ON/OFF timing sequence is illustrated as below:

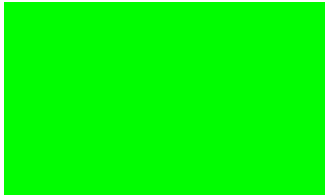

5.9. The BIST Patterns for Aging Mode Test

ILI6137B supports the function to generate BIST patterns for Aging mode test automatically. When external BIST pin goes “H” level, then ILI6137B will leave Normal operation mode and starts to generate the BIST patterns to LCD panel without external clock signal, The BIST patterns is illustrated as below:

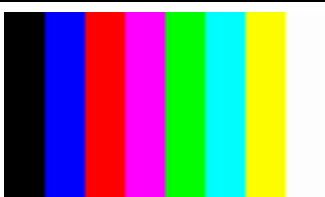
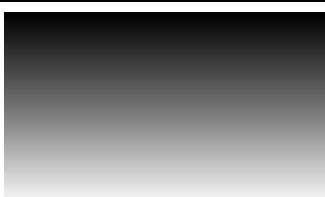
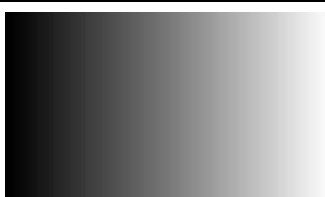
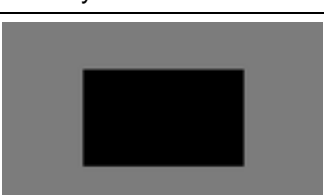
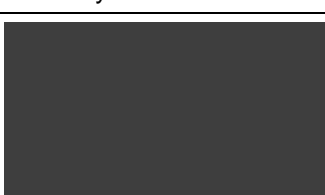
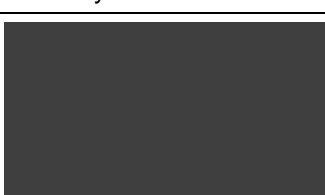
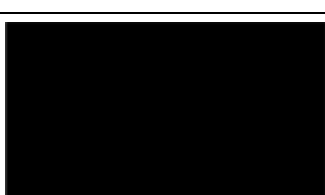
1	2	3	4
Red	Green	Blue	Black
			
5	6	7	8
White	Vertical 8-color stripe	Horizontal 64-gray scale	Vertical 64-gray scale
			
9	10	11	12
Gray with black block	Gray with black dot	Gray with black line	Black with white frame
			

5.10. The Command Format for 3-line Serial Interface

ILI6137B using the 3-line serial port as communication interface for all the commands and parameters of CABC function. This 3-line serial communication can be bi-directional controlled by the “R/W” bit in address field. Under read mode, the 3-line engine in ILI6137B will return the data during “Data phase”. The returned data should be latched at the rising edge of SPCK by external controller. Data in the “Hi-Z phase” will be ignored by 3-line engine during write operation, and should be ignored during read operation also. During read operation, external controller should float SPDA pin under “Hi-Z phase” and “Data phase”.

Each Read/Write operation should be exactly 17 bit. To prevent from incorrect setting of the internal register, any write operation with more or less than 17 bit data during a CSX Low period will be ignored by 3-line engine.

The timing diagram of read/write operation is illustrated as below:

Write Operation

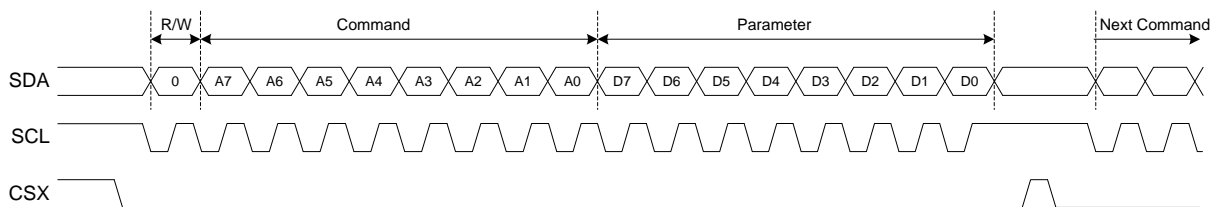

Read Operation

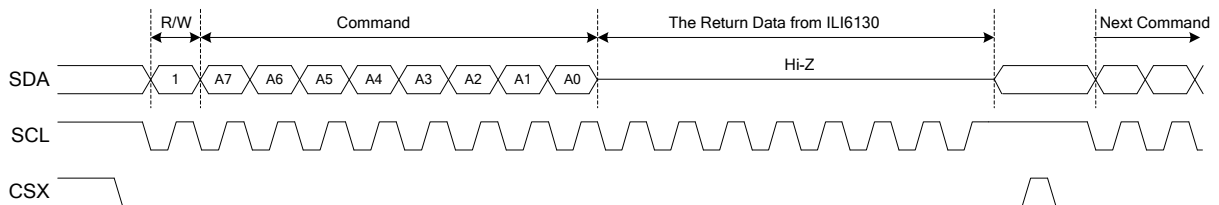

6. DC Characteristic

6.1. Absolute Maximum Rating (VSS = VSSA=0V, Ta=25°C)

Parameter	Symbol	Spec			Unit
		Min.	Typ.	Max.	
Power supply voltage 1	VDD	-0.5	--	+5.0	V
Power supply voltage 2	VDDA	-0.5	--	+13.5	V
Gamma correction voltage	V1 ~ V14	-0.5	--	+13.5	V
Input voltage	Vin	-0.3	--	VDD+0.3	V
Operation temperature	TOPR	-20	--	+85	°C
Storage temperature	TSTG	-55	--	+125	°C

Note: (1) All of the voltages listed above are with respect to VSS=VSSA=0V.

(2) Device is subject to be damaged permanently if stresses beyond those absolute maximum ratings listed above.

6.2. DC Electrical Characteristics (VSS=VSSA=0V, Ta=25°C)

Parameter	Symbol	Spec			Unit	Conditions
		Min.	Typ.	Max.		
Power supply voltage	VDD	3.0	3.3	3.6	V	--
Power supply voltage	VDDA	8.5	10.4	13.5	V	--
Low level input voltage	V _{IL}	0	--	0.3*VDD	V	For the digital circuit block
High level input voltage	V _{IH}	0.7*VDD	--	VDD	V	For the digital circuit block
Output low voltage	V _{OL}	--	--	VSS+0.4	V	IOL=+400μA
Output high voltage	V _{OH}	VDD-0.4	--	--	V	IOH=-400μA
Input leakage current	I _{IN}	--	--	±1	μA	No pull up or pull down.
Input level of V1~V7	V _{REF1}	0.5*VDDA	--	VDDA-0.1	V	Gamma correction voltage input
Input level of V8~V14	V _{REF2}	0.1	--	0.5*VDDA	V	Gamma correction voltage input
Output voltage deviation	V _{OD1}	--	±20	±35	mV	VO=VSSA+0.1V ~ VSSA+0.5V and VO=VDDA-0.1V ~ VDDA-0.5V
Output voltage deviation	V _{OD2}	--	±15	±20	mV	VO= VSSA+0.5V ~ VDDA-0.5V
DC offset	V _{OS}	--	--	±20	mV	VO= VSSA+0.5V ~ VDDA-0.5V
Dynamic output range	V _{DR}	0.1	--	VDDA-0.1	V	S1 ~ S1200
Pull high/low resistance	R _H	200	250	300	kΩ	For digital input pins at VDD=3.3V
Output sinking current	I _{OL}	80	--	--	μA	S1~S1200, VO =0.1V vs. 1.0V, VDDA=13.5V
Output driving current	I _{OH}	80	--	--	μA	S1~S1200, VO=13.4V vs. 12.5V, VDDA=13.5V
Analog operating current	I _{DDA}	--	10	12	mA	Without loading, FCLK=50MHz, FLD=48kHz, VDDA=10V, V1=8V, V14=0.4V
Digital operating current	I _{DD}	--	8	10	mA	FCLK=50MHz, FLD=48kHz, VDD=3.3V
Analog standby current	I _{STBA}	--	10	50	μA	No loading, clock and all functions are stopped
Digital standby current	I _{STBD}	--	10	50	μA	Clock and all functions are stopped

Note: VDD=3.0 ~ 3.6V, VDDA=8.5~13.5V, VSS=VSSA=0V, Ta= -20 ~ +85°C

7. AC Characteristics

7.1. AC Timing characteristics

DE Mode (MODE= H)

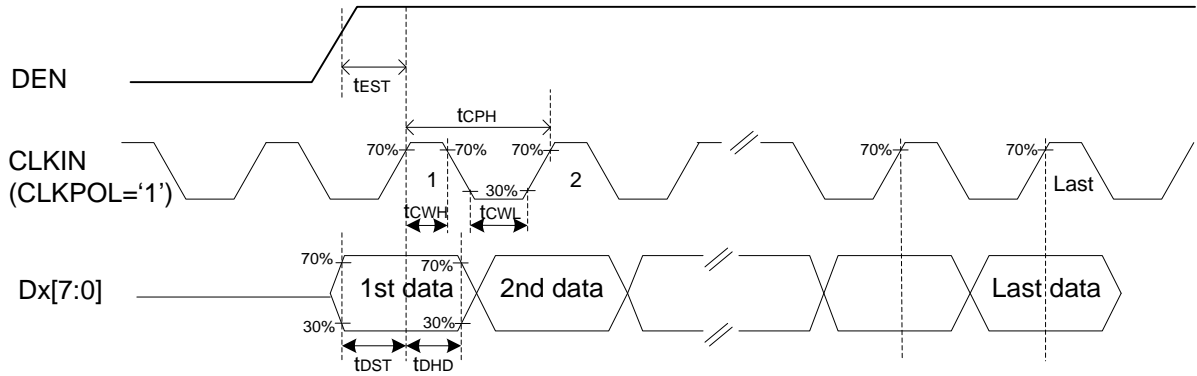

SYNC Mode (MODE= L)

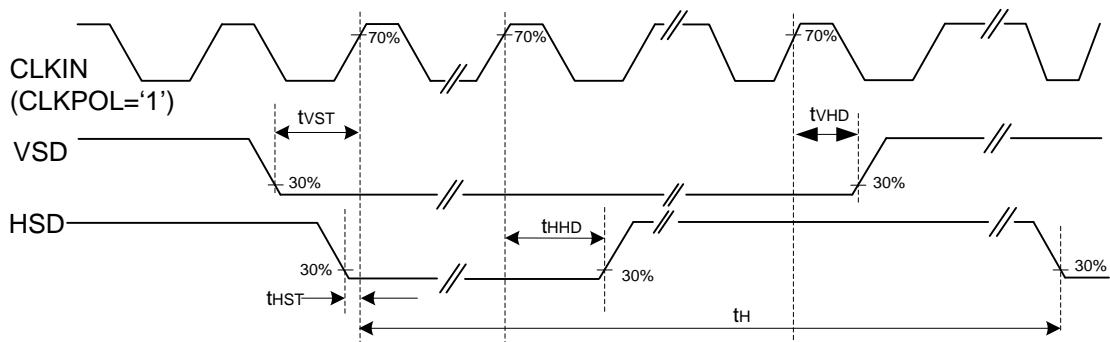

Source Output timing Diagram (Cascade)

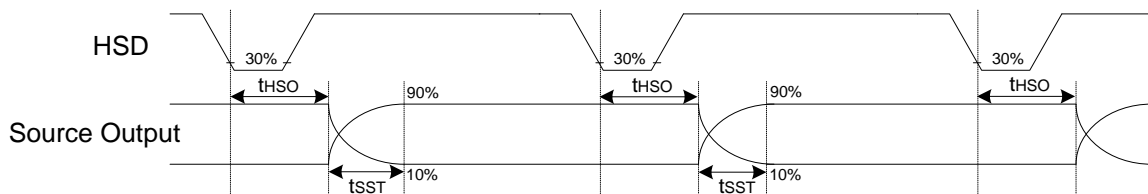

Vertical Timing Diagram of SYNC Mode (Dual Gate)

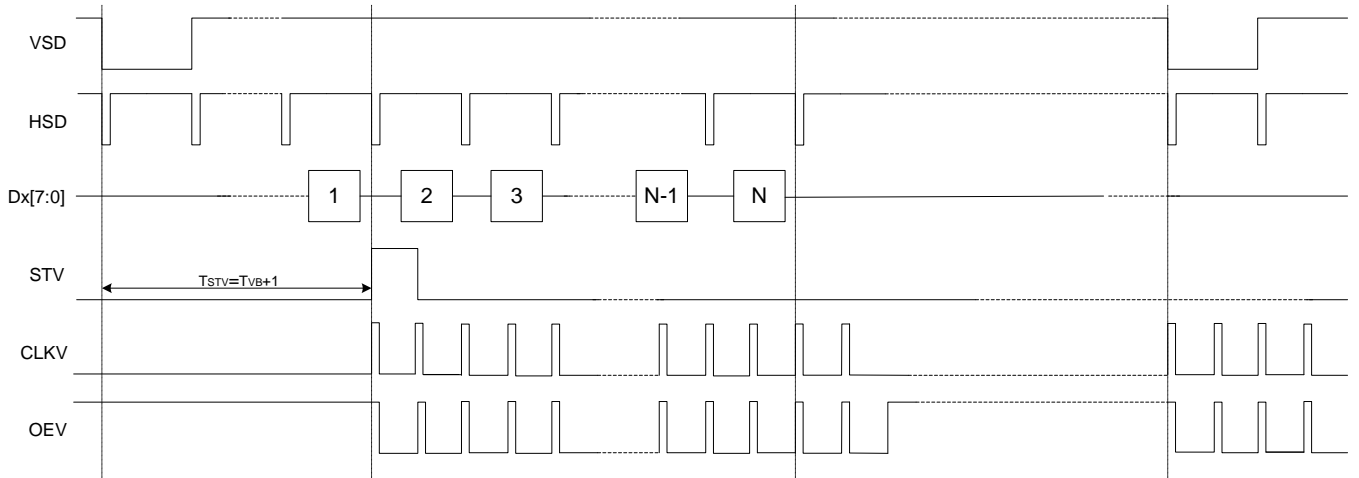

Vertical Timing Diagram of DE Mode (Dual Gate)

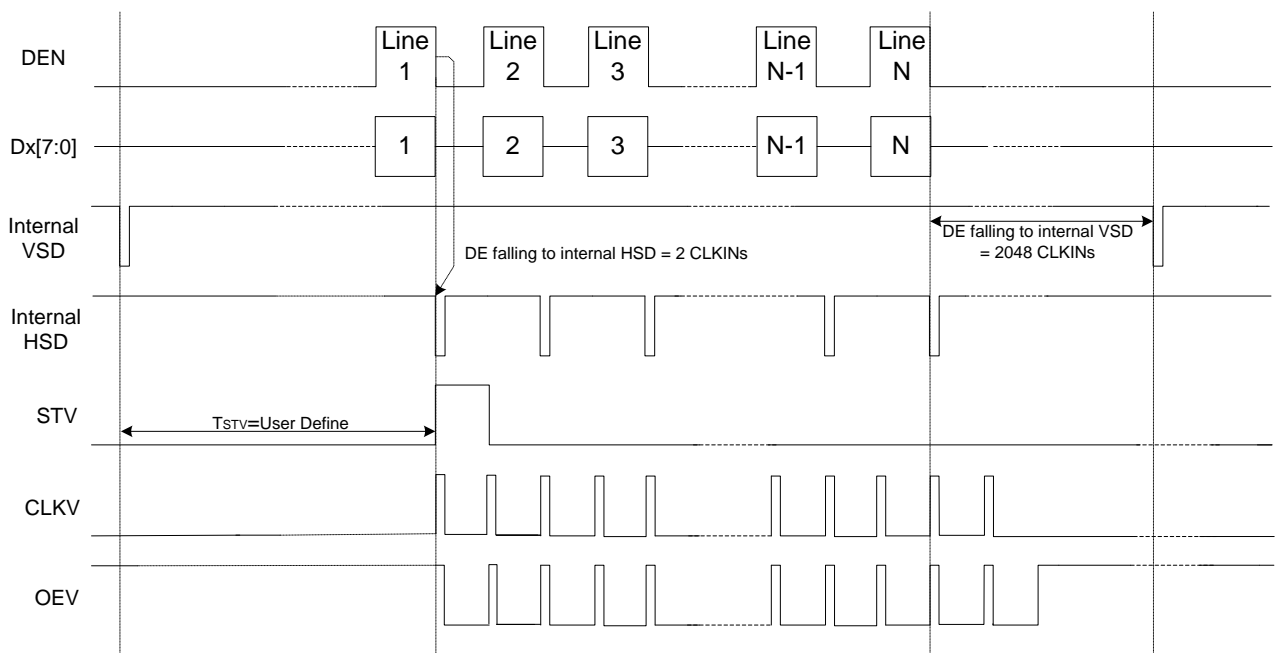

Gate Output Timing Diagram (Dual Gate)

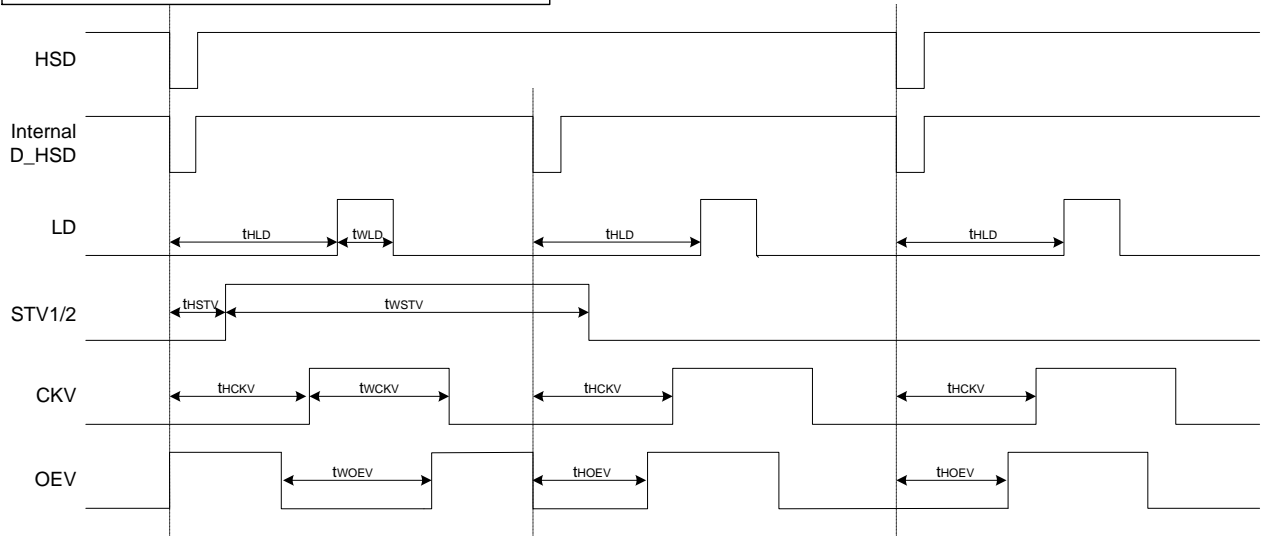

Parameter	Symbol	Spec			Unit	Conditions
		Min.	Typ.	Max.		
VDD Power ON slew rate	t_{POR}	--	--	20	ms	$0V \sim 0.9 \cdot VDD$
RSTB pulse width	t_{RST}	10	--	--	us	CLKIN=50MHz
CLKIN cycle time	t_{CPH}	20	--	--	ns	
CLKIN pulse duty	t_{CWH}	40	50	60	%	
VSD setup time	t_{VST}	8	--	--	ns	
VSD hold time	t_{VHD}	8	--	--	ns	
HSD setup time	t_{HST}	8	--	--	ns	
HSD hold time	t_{HHD}	8	--	--	ns	
Data setup time	t_{DST}	8	--	--	ns	D0[7:0], D1[7:0], D2[7:0] to CLKIN
Data hold time	t_{DHD}	8	--	--	ns	D0[7:0], D1[7:0], D2[7:0] to CLKIN
DE setup time	t_{EST}	8	--	--	ns	
DE hold time	t_{EHD}	8	--	--	ns	
Output stable time	t_{SST}	--	--	6	us	10% to 90% target voltage. CL=120pF, R=10K Ω
CLKIN frequency	f_{CLK}	--	40	50	MHz	VDD=3.0 ~ 3.6V
CLKIN cycle time	t_{CLK}	20	25	--	ns	
CLKIN pulse duty	t_{CWH}	40	50	60	%	T_{CLK}
Time from HSD to Source output	t_{HSO}	--	20	--	CLKIN	
Time from HSD to LD	t_{HLD}	--	20	--	CLKIN	Note (2)
Time from HSD to STV	t_{HSTV}	--	2	--	CLKIN	
Time from HSD to CKV	t_{HCKV}	--	20	--	CLKIN	
LD pulse width	t_{WLD}	--	10	--	CLKIN	Note (2)
CKV pulse width	t_{WCKV}	--	66	--	CLKIN	
OEV pulse width	t_{WOEV}	--	74	--	CLKIN	

Note: (1) VDD=3.0 ~ 3.6V, VDDA=8.5~13.5V, VSS=VSSA=0V, Ta= -20 ~ +85°C

(2) The contents of the data register are transferred to the latch circuit at the rising edge of LD. Then the gray scale voltage is output from the device at the falling edge of LD.

(3) Output loading condition:

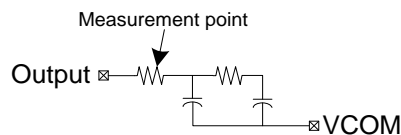

SPI Timing

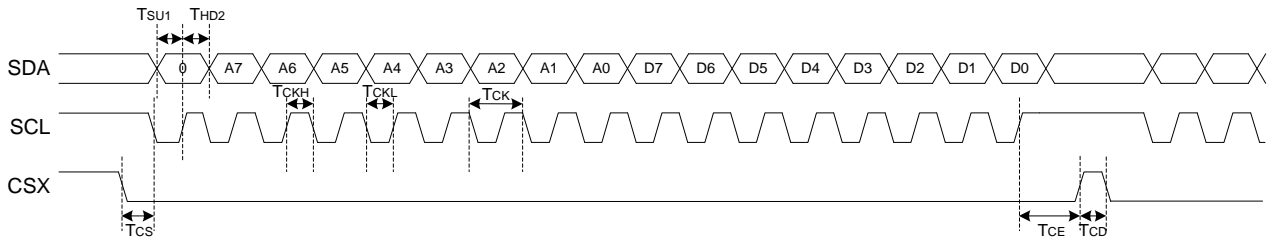

Parameter	Symbol	Spec			Unit	Conditions
		Min.	Typ.	Max.		
SCL period	T_{CK}	60	--	--	ns	
SCL high width	T_{CKH}	30	--	--	ns	
SCL low width	T_{CKL}	30	--	--	ns	
Data setup time	T_{SU1}	12	--	--	ns	
Data hold time	T_{HD1}	12	--	--	ns	
CSX to SCL setup time	T_{CS}	20	--	--	ns	
CSX to SDA hold time	T_{CE}	20	--	--	ns	
CSX high pulse width	T_{CD}	50	--	--	ns	

7.2. Display Timing characteristics

7.2.1. Resolution: 800x480

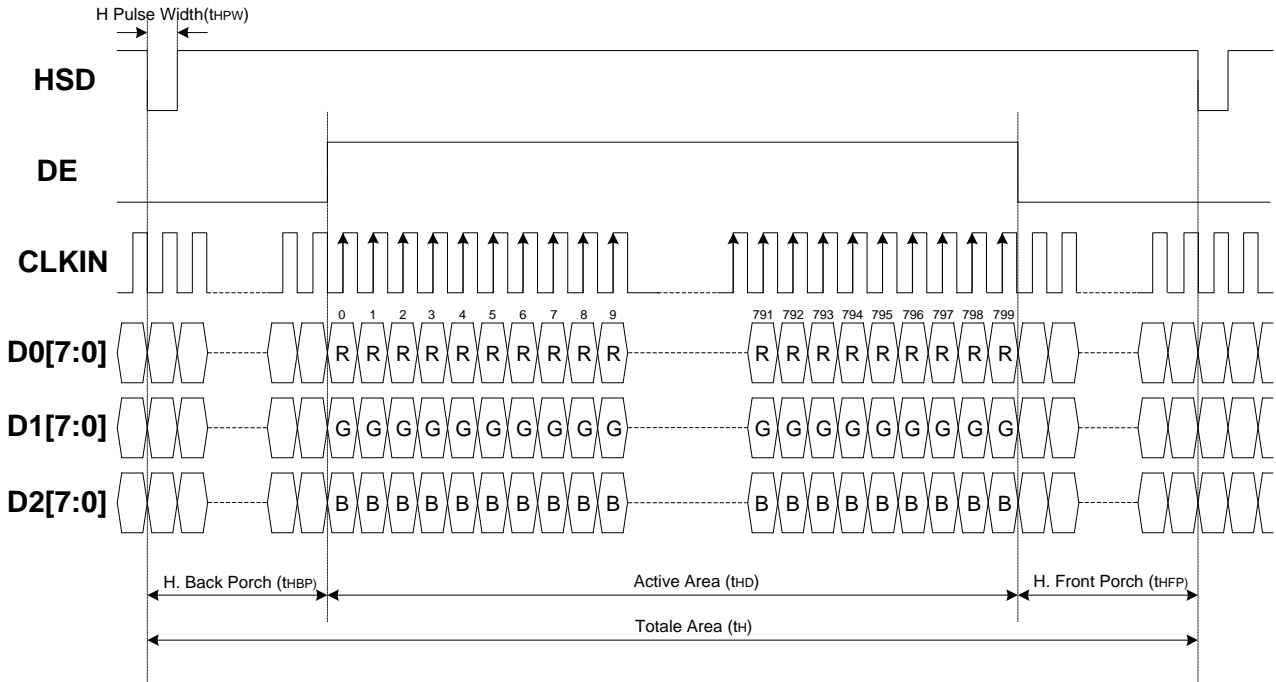

Horizontal Input Timing						
Parameter	Symbol	Value			Unit	
		Min.	Typ.	Max.		
Horizontal display area	t _{HD}	--	800	--	CLKIN	
CLKIN frequency	f _{CLK}	--	33.3	50	MHz	
1 Horizontal line period	t _H	862	1056	1200	CLKIN	
HSD pulse width	Min.	--	1	--	CLKIN	
	Typ.	--	--	--	CLKIN	
	Max.	--	40	--	CLKIN	
HSD back porch	SYNC	t _{HBP}	46	46	46	CLKIN
HSD front porch	SYNC	t _{HFP}	16	210	354	CLKIN

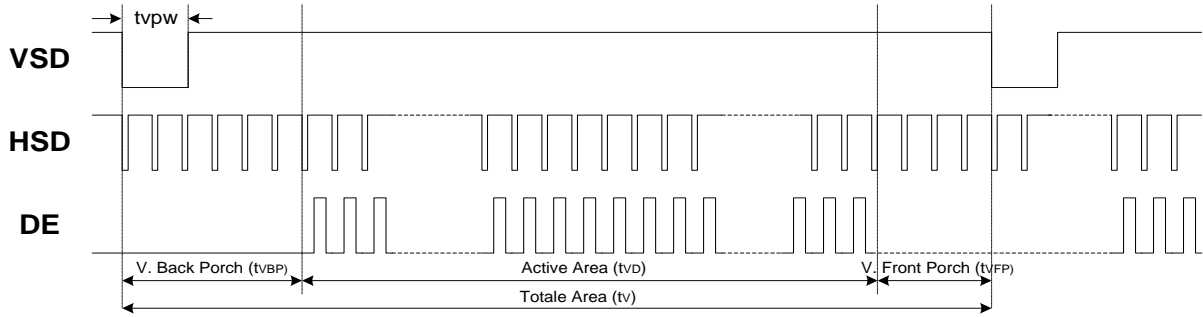

Vertical Input Timing					
Parameter	Symbol	Value			Unit
		Min.	Typ.	Max.	
Vertical display area	t_{vD}	--	480	--	HSD
VSD period time	t_v	510	525	650	HSD
VSD pulse width	t_{vPW}	1	--	20	HSD
VSD back porch	t_{vBP}	23	23	23	HSD
VSD front porch	t_{vFP}	7	22	147	HSD

7.2.2. Resolution: 800x600

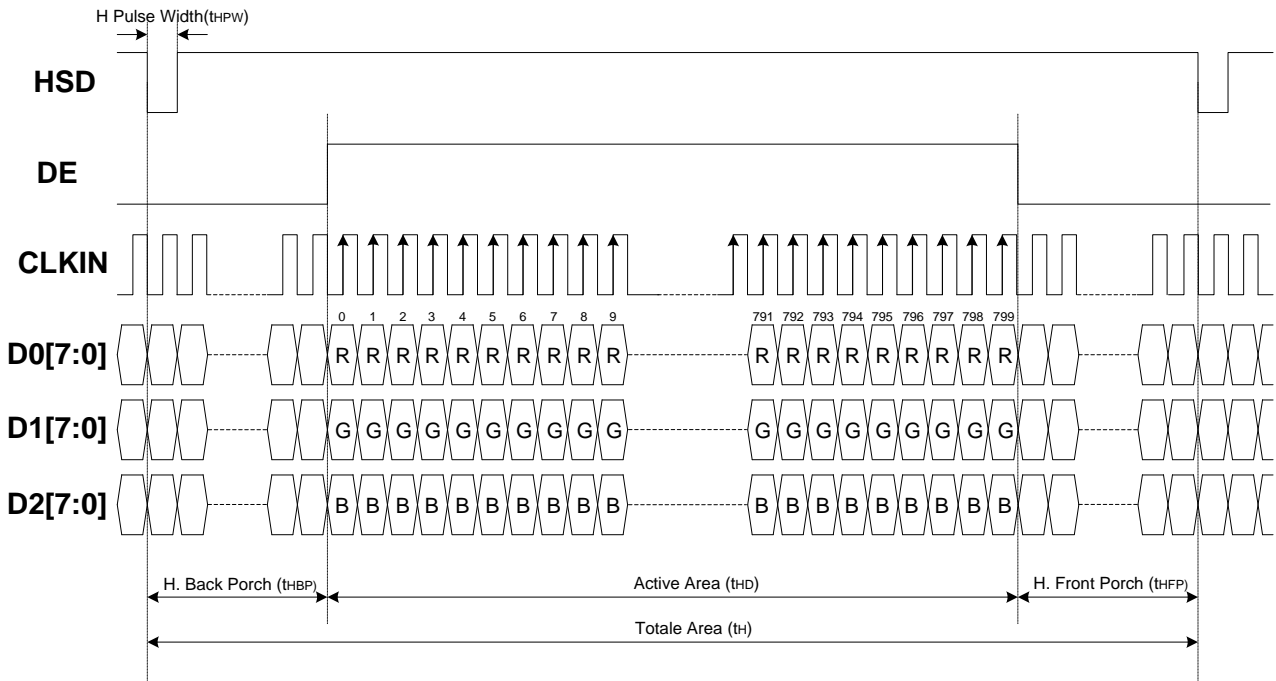

Horizontal Input Timing						
Parameter	Symbol	Value			Unit	
		Min.	Typ.	Max.		
Horizontal display area	t_{HD}	--	800	--	CLKIN	
CLKIN frequency	f_{CLK}	--	40	50	MHz	
1 Horizontal line period	t_H	862	1056	1200	CLKIN	
HSD pulse width	Min.	--	1	--	CLKIN	
	Typ.	--	--	--	CLKIN	
	Max.	--	40	--	CLKIN	
HSD back porch	SYNC	t_{HBP}	46	46	46	CLKIN
HSD front porch	SYNC	t_{HFP}	16	210	354	CLKIN

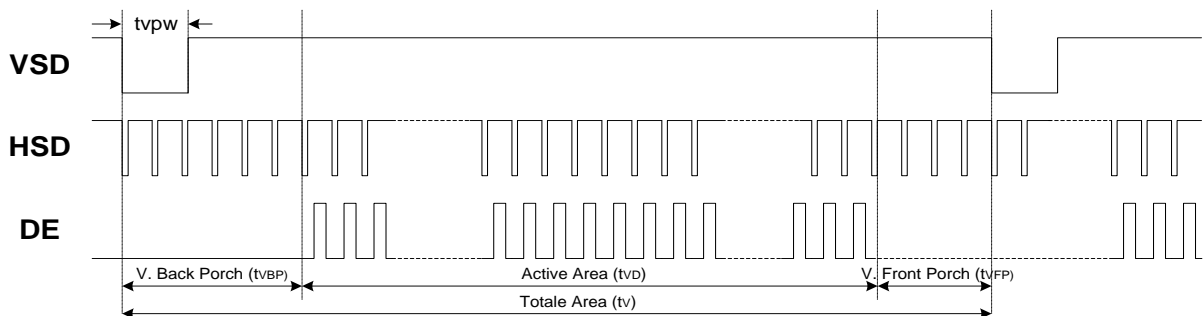

Vertical Input Timing					
Parameter	Symbol	Value			Unit
		Min.	Typ.	Max.	
Vertical display area	t_{VD}	--	600	--	HSD
VSD period time	t_V	624	635	700	HSD
VSD pulse width	t_{VPW}	1	--	20	HSD
VSD back proch	t_{VBP}	23	23	23	HSD
VSD front porch	t_{VFP}	1	12	77	HSD

9. Pad Arrangement and Coordination

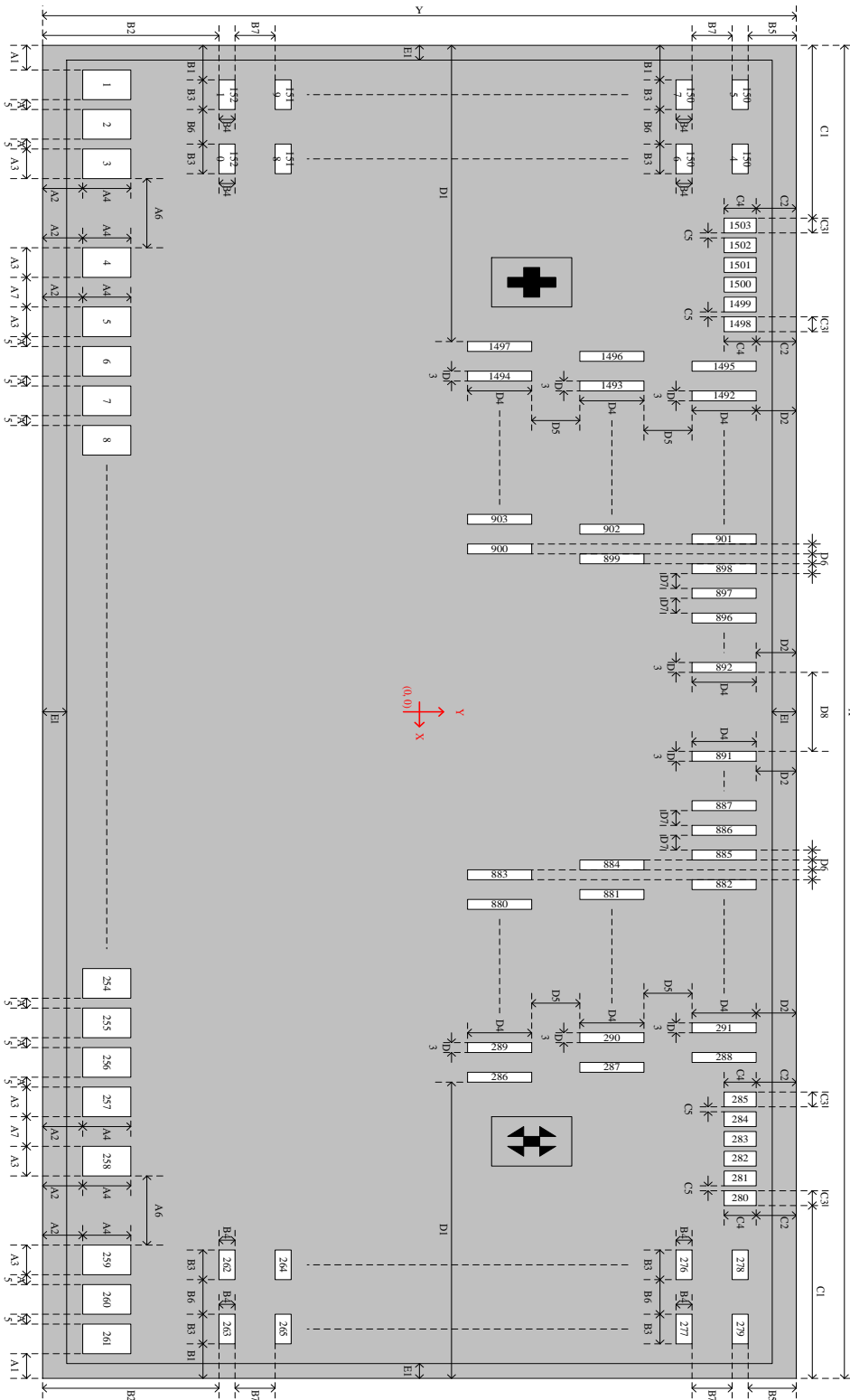

Symbol	Dimension (um)
A1	48.5
A2	48.5
A3	60
A4	65
A5	25
A6	141.5
A7	55
B1	66
B2	219.5
B3	60
B4	30
B5	58.5
B6	70
B7	50
C1	346
C2	48.5
C3	30
C4	40
C5	20
D1	646
D2	48.5
D3	17
D4	80
D5	60
D6	17
D7	17
D8	450
E1	30
X	22550
Y	948

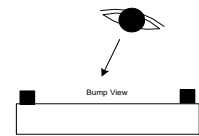

Chip size: 22550 um x 948 um(Include 60um scribe line).

Chip height: 400 um .

Bump height: 9 um .

No.	Pad name	X	Y	No.	Pad name	X	Y	No.	Pad name	X	Y	No.	Pad name	X	Y
1	SHIELDING	-11196.5	-393	59	SHIELDING	-6120	-393	117	V3	-1190	-393	175	VSD	3740	-393
2	SHIELDING	-11111.5	-393	60	TN5	-6035	-393	118	V3	-1105	-393	176	DASHD	3825	-393
3	SHIELDING	-11026.5	-393	61	TN5	-5950	-393	119	SHIELDING	-1020	-393	177	HSD	3910	-393
4	SHIELDING	-10825	-393	62	SHIELDING	-5865	-393	120	V4	-935	-393	178	HSD	3995	-393
5	COM1_B	-10710	-393	63	CLKPOL	-5780	-393	121	V4	-850	-393	179	DASHD	4080	-393
6	COM1_B	-10625	-393	64	CLKPOL	-5695	-393	122	SHIELDING	-765	-393	180	DEN	4165	-393
7	SHIELDING	-10540	-393	65	SHIELDING	-5610	-393	123	V5	-680	-393	181	DEN	4250	-393
8	SHIELDING	-10455	-393	66	DITHB	-5525	-393	124	V5	-595	-393	182	DASHD	4335	-393
9	VSSA	-10370	-393	67	DITHB	-5440	-393	125	SHIELDING	-510	-393	183	CLKIN	4420	-393
10	VSSA	-10285	-393	68	SHIELDING	-5355	-393	126	V6	-425	-393	184	CLKIN	4505	-393
11	VSSA	-10200	-393	69	MODE	-5270	-393	127	V6	-340	-393	185	DASHD	4590	-393
12	VSSA	-10115	-393	70	MODE	-5185	-393	128	SHIELDING	-255	-393	186	D27	4675	-393
13	SHIELDING	-10030	-393	71	SHIELDING	-5100	-393	129	V7	-170	-393	187	D27	4760	-393
14	TN0	-9945	-393	72	SHLR	-5015	-393	130	V7	-85	-393	188	D26	4845	-393
15	TN0	-9860	-393	73	SHLR	-4930	-393	131	SHIELDING	0	-393	189	D26	4930	-393
16	SHIELDING	-9775	-393	74	SHIELDING	-4845	-393	132	V8	85	-393	190	DASHD	5015	-393
17	TN1	-9690	-393	75	UPDN	-4760	-393	133	V8	170	-393	191	D25	5100	-393
18	TN1	-9605	-393	76	UPDN	-4675	-393	134	SHIELDING	255	-393	192	D25	5185	-393
19	TP0	-9520	-393	77	SHIELDING	-4590	-393	135	V9	340	-393	193	D24	5270	-393
20	TP0	-9435	-393	78	STBYB	-4505	-393	136	V9	425	-393	194	D24	5355	-393
21	TP1	-9350	-393	79	STBYB	-4420	-393	137	SHIELDING	510	-393	195	DASHD	5440	-393
22	TP1	-9265	-393	80	SHIELDING	-4335	-393	138	V10	595	-393	196	D23	5525	-393
23	TP2	-9180	-393	81	RSTB	-4250	-393	139	V10	680	-393	197	D23	5610	-393
24	TP2	-9095	-393	82	RSTB	-4165	-393	140	SHIELDING	765	-393	198	D22	5695	-393
25	TP3	-9010	-393	83	SHIELDING	-4080	-393	141	V11	850	-393	199	D22	5780	-393
26	TP3	-8925	-393	84	BLKEN	-3995	-393	142	V11	935	-393	200	DASHD	5865	-393
27	TP4	-8840	-393	85	BLKEN	-3910	-393	143	SHIELDING	1020	-393	201	D21	5950	-393
28	TP4	-8755	-393	86	SHIELDING	-3825	-393	144	V12	1105	-393	202	D21	6035	-393
29	Dummy	-8670	-393	87	VSET	-3740	-393	145	V12	1190	-393	203	D20	6120	-393
30	TP5	-8585	-393	88	VSET	-3655	-393	146	SHIELDING	1275	-393	204	D20	6205	-393
31	SHIELDING	-8500	-393	89	TP6	-3570	-393	147	V13	1360	-393	205	DASHD	6290	-393
32	TN2	-8415	-393	90	TP6	-3485	-393	148	V13	1445	-393	206	D17	6375	-393
33	TN2	-8330	-393	91	TP7	-3400	-393	149	SHIELDING	1530	-393	207	D17	6460	-393
34	SHIELDING	-8245	-393	92	TP7	-3315	-393	150	V14	1615	-393	208	D16	6545	-393
35	TN3	-8160	-393	93	TP8	-3230	-393	151	V14	1700	-393	209	D16	6630	-393
36	TN3	-8075	-393	94	TP8	-3145	-393	152	SHIELDING	1785	-393	210	DASHD	6715	-393
37	SHIELDING	-7990	-393	95	TP9	-3060	-393	153	VSSA	1870	-393	211	D15	6800	-393
38	TN4	-7905	-393	96	TP9	-2975	-393	154	VSSA	1955	-393	212	D15	6885	-393
39	TN4	-7820	-393	97	TP10	-2890	-393	155	VSSA	2040	-393	213	D14	6970	-393
40	SHIELDING	-7735	-393	98	Dummy	-2805	-393	156	VSSA	2125	-393	214	D14	7055	-393
41	CSX	-7650	-393	99	TN7	-2720	-393	157	VSSA	2210	-393	215	DASHD	7140	-393
42	CSX	-7565	-393	100	DUMMY	-2635	-393	158	VSSA	2295	-393	216	D13	7225	-393
43	SHIELDING	-7480	-393	101	SHIELDING	-2550	-393	159	VSSA	2380	-393	217	D13	7310	-393
44	SCL	-7395	-393	102	VDDA	-2465	-393	160	VSSA	2465	-393	218	D12	7395	-393
45	SCL	-7310	-393	103	VDDA	-2380	-393	161	SHIELDING	2550	-393	219	D12	7480	-393
46	SHIELDING	-7225	-393	104	VDDA	-2295	-393	162	SHIELDING	2635	-393	220	DASHD	7565	-393
47	SDA	-7140	-393	105	VDDA	-2210	-393	163	VSS	2720	-393	221	D11	7650	-393
48	SDA	-7055	-393	106	VDDA	-2125	-393	164	VSS	2805	-393	222	D11	7735	-393
49	SHIELDING	-6970	-393	107	VDDA	-2040	-393	165	VSS	2890	-393	223	D10	7820	-393
50	SHIELDING	-6885	-393	108	VDDA	-1955	-393	166	VSS	2975	-393	224	D10	7905	-393
51	GOSEQ	-6800	-393	109	VDDA	-1870	-393	167	SHIELDING	3060	-393	225	DASHD	7990	-393
52	GOSEQ	-6715	-393	110	SHIELDING	-1785	-393	168	SHIELDING	3145	-393	226	D07	8075	-393
53	SHIELDING	-6630	-393	111	V1	-1700	-393	169	VDD	3230	-393	227	D07	8160	-393
54	BIST	-6545	-393	112	V1	-1615	-393	170	VDD	3315	-393	228	D06	8245	-393
55	BIST	-6460	-393	113	SHIELDING	-1530	-393	171	VDD	3400	-393	229	D06	8330	-393
56	SHIELDING	-6375	-393	114	V2	-1445	-393	172	VDD	3485	-393	230	DASHD	8415	-393
57	RES0	-6290	-393	115	V2	-1360	-393	173	DASHD	3570	-393	231	D05	8500	-393
58	RES0	-6205	-393	116	SHIELDING	-1275	-393	174	VSD	3655	-393	232	D05	8585	-393

No.	Pad name	X	Y	No.	Pad name	X	Y	No.	Pad name	X	Y	No.	Pad name	X	Y
233	D04	8670	-393	291	SO[6]	10535.5	385.5	349	SO[64]	9549.5	105.5	407	SO[122]	8563.5	245.5
234	D04	8755	-393	292	SO[7]	10518.5	105.5	350	SO[65]	9532.5	245.5	408	SO[123]	8546.5	385.5
235	DASHD	8840	-393	293	SO[8]	10501.5	245.5	351	SO[66]	9515.5	385.5	409	SO[124]	8529.5	105.5
236	D03	8925	-393	294	SO[9]	10484.5	385.5	352	SO[67]	9498.5	105.5	410	SO[125]	8512.5	245.5
237	D03	9010	-393	295	SO[10]	10467.5	105.5	353	SO[68]	9481.5	245.5	411	SO[126]	8495.5	385.5
238	D02	9095	-393	296	SO[11]	10450.5	245.5	354	SO[69]	9464.5	385.5	412	SO[127]	8478.5	105.5
239	D02	9180	-393	297	SO[12]	10433.5	385.5	355	SO[70]	9447.5	105.5	413	SO[128]	8461.5	245.5
240	DASHD	9265	-393	298	SO[13]	10416.5	105.5	356	SO[71]	9430.5	245.5	414	SO[129]	8444.5	385.5
241	D01	9350	-393	299	SO[14]	10399.5	245.5	357	SO[72]	9413.5	385.5	415	SO[130]	8427.5	105.5
242	D01	9435	-393	300	SO[15]	10382.5	385.5	358	SO[73]	9396.5	105.5	416	SO[131]	8410.5	245.5
243	D00	9520	-393	301	SO[16]	10365.5	105.5	359	SO[74]	9379.5	245.5	417	SO[132]	8393.5	385.5
244	D00	9605	-393	302	SO[17]	10348.5	245.5	360	SO[75]	9362.5	385.5	418	SO[133]	8376.5	105.5
245	DASHD	9690	-393	303	SO[18]	10331.5	385.5	361	SO[76]	9345.5	105.5	419	SO[134]	8359.5	245.5
246	SHIELDING	9775	-393	304	SO[19]	10314.5	105.5	362	SO[77]	9328.5	245.5	420	SO[135]	8342.5	385.5
247	SHIELDING	9860	-393	305	SO[20]	10297.5	245.5	363	SO[78]	9311.5	385.5	421	SO[136]	8325.5	105.5
248	SHIELDING	9945	-393	306	SO[21]	10280.5	385.5	364	SO[79]	9294.5	105.5	422	SO[137]	8308.5	245.5
249	SHIELDING	10030	-393	307	SO[22]	10263.5	105.5	365	SO[80]	9277.5	245.5	423	SO[138]	8291.5	385.5
250	VDDA	10115	-393	308	SO[23]	10246.5	245.5	366	SO[81]	9260.5	385.5	424	SO[139]	8274.5	105.5
251	VDDA	10200	-393	309	SO[24]	10229.5	385.5	367	SO[82]	9243.5	105.5	425	SO[140]	8257.5	245.5
252	VDDA	10285	-393	310	SO[25]	10212.5	105.5	368	SO[83]	9226.5	245.5	426	SO[141]	8240.5	385.5
253	VDDA	10370	-393	311	SO[26]	10195.5	245.5	369	SO[84]	9209.5	385.5	427	SO[142]	8223.5	105.5
254	SHIELDING	10455	-393	312	SO[27]	10178.5	385.5	370	SO[85]	9192.5	105.5	428	SO[143]	8206.5	245.5
255	SHIELDING	10540	-393	313	SO[28]	10161.5	105.5	371	SO[86]	9175.5	245.5	429	SO[144]	8189.5	385.5
256	COM2_B	10625	-393	314	SO[29]	10144.5	245.5	372	SO[87]	9158.5	385.5	430	SO[145]	8172.5	105.5
257	COM2_B	10710	-393	315	SO[30]	10127.5	385.5	373	SO[88]	9141.5	105.5	431	SO[146]	8155.5	245.5
258	SHIELDING	10825	-393	316	SO[31]	10110.5	105.5	374	SO[89]	9124.5	245.5	432	SO[147]	8138.5	385.5
259	SHIELDING	11026.5	-393	317	SO[32]	10093.5	245.5	375	SO[90]	9107.5	385.5	433	SO[148]	8121.5	105.5
260	SHIELDING	11111.5	-393	318	SO[33]	10076.5	385.5	376	SO[91]	9090.5	105.5	434	SO[149]	8104.5	245.5
261	SHIELDING	11196.5	-393	319	SO[34]	10059.5	105.5	377	SO[92]	9073.5	245.5	435	SO[150]	8087.5	385.5
262	DUMMY	11049	-239.5	320	SO[35]	10042.5	245.5	378	SO[93]	9056.5	385.5	436	SO[151]	8070.5	105.5
263	DUMMY	11179	-239.5	321	SO[36]	10025.5	385.5	379	SO[94]	9039.5	105.5	437	SO[152]	8053.5	245.5
264	STBNL	11049	-159.5	322	SO[37]	10008.5	105.5	380	SO[95]	9022.5	245.5	438	SO[153]	8036.5	385.5
265	STBNL	11179	-159.5	323	SO[38]	9991.5	245.5	381	SO[96]	9005.5	385.5	439	SO[154]	8019.5	105.5
266	STV1L	11049	-79.5	324	SO[39]	9974.5	385.5	382	SO[97]	8988.5	105.5	440	SO[155]	8002.5	245.5
267	STV1L	11179	-79.5	325	SO[40]	9957.5	105.5	383	SO[98]	8971.5	245.5	441	SO[156]	7985.5	385.5
268	STV2L	11049	0.5	326	SO[41]	9940.5	245.5	384	SO[99]	8954.5	385.5	442	SO[157]	7968.5	105.5
269	STV2L	11179	0.5	327	SO[42]	9923.5	385.5	385	SO[100]	8937.5	105.5	443	SO[158]	7951.5	245.5
270	STV1L	11049	80.5	328	SO[43]	9906.5	105.5	386	SO[101]	8920.5	245.5	444	SO[159]	7934.5	385.5
271	STV1L	11179	80.5	329	SO[44]	9889.5	245.5	387	SO[102]	8903.5	385.5	445	SO[160]	7917.5	105.5
272	CKVL	11049	160.5	330	SO[45]	9872.5	385.5	388	SO[103]	8886.5	105.5	446	SO[161]	7900.5	245.5
273	CKVL	11179	160.5	331	SO[46]	9855.5	105.5	389	SO[104]	8869.5	245.5	447	SO[162]	7883.5	385.5
274	UDL	11049	240.5	332	SO[47]	9838.5	245.5	390	SO[105]	8852.5	385.5	448	SO[163]	7866.5	105.5
275	UDL	11179	240.5	333	SO[48]	9821.5	385.5	391	SO[106]	8835.5	105.5	449	SO[164]	7849.5	245.5
276	OEVL	11049	320.5	334	SO[49]	9804.5	105.5	392	SO[107]	8818.5	245.5	450	SO[165]	7832.5	385.5
277	OEVL	11179	320.5	335	SO[50]	9787.5	245.5	393	SO[108]	8801.5	385.5	451	SO[166]	7815.5	105.5
278	INVBRL	11049	400.5	336	SO[51]	9770.5	385.5	394	SO[109]	8784.5	105.5	452	SO[167]	7798.5	245.5
279	INVBRL	11179	400.5	337	SO[52]	9753.5	105.5	395	SO[110]	8767.5	245.5	453	SO[168]	7781.5	385.5
280	TN8	10914	405.5	338	SO[53]	9736.5	245.5	396	SO[111]	8750.5	385.5	454	SO[169]	7764.5	105.5
281	TN8	10864	405.5	339	SO[54]	9719.5	385.5	397	SO[112]	8733.5	105.5	455	SO[170]	7747.5	245.5
282	SHIELDING	10814	405.5	340	SO[55]	9702.5	105.5	398	SO[113]	8716.5	245.5	456	SO[171]	7730.5	385.5
283	COM2_T	10764	405.5	341	SO[56]	9685.5	245.5	399	SO[114]	8699.5	385.5	457	SO[172]	7713.5	105.5
284	COM2_T	10714	405.5	342	SO[57]	9668.5	385.5	400	SO[115]	8682.5	105.5	458	SO[173]	7696.5	245.5
285	SHIELDING	10664	405.5	343	SO[58]	9651.5	105.5	401	SO[116]	8665.5	245.5	459	SO[174]	7679.5	385.5
286	SO[1]	10620.5	105.5	344	SO[59]	9634.5	245.5	402	SO[117]	8648.5	385.5	460	SO[175]	7662.5	105.5
287	SO[2]	10603.5	245.5	345	SO[60]	9617.5	385.5	403	SO[118]	8631.5	105.5	461	SO[176]	7645.5	245.5
288	SO[3]	10586.5	385.5	346	SO[61]	9600.5	105.5	404	SO[119]	8614.5	245.5	462	SO[177]	7628.5	385.5
289	SO[4]	10569.5	105.5	347	SO[62]	9583.5	245.5	405	SO[120]	8597.5	385.5	463	SO[178]	7611.5	105.5
290	SO[5]	10552.5	245.5	348	SO[63]	9566.5	385.5	406	SO[121]	8580.5	105.5	464	SO[179]	7594.5	245.5

No.	Pad name	X	Y	No.	Pad name	X	Y	No.	Pad name	X	Y	No.	Pad name	X	Y
465	SO[180]	7577.5	385.5	523	SO[238]	6591.5	105.5	581	SO[296]	5605.5	245.5	639	SO[354]	4619.5	385.5
466	SO[181]	7560.5	105.5	524	SO[239]	6574.5	245.5	582	SO[297]	5588.5	385.5	640	SO[355]	4602.5	105.5
467	SO[182]	7543.5	245.5	525	SO[240]	6557.5	385.5	583	SO[298]	5571.5	105.5	641	SO[356]	4585.5	245.5
468	SO[183]	7526.5	385.5	526	SO[241]	6540.5	105.5	584	SO[299]	5554.5	245.5	642	SO[357]	4568.5	385.5
469	SO[184]	7509.5	105.5	527	SO[242]	6523.5	245.5	585	SO[300]	5537.5	385.5	643	SO[358]	4551.5	105.5
470	SO[185]	7492.5	245.5	528	SO[243]	6506.5	385.5	586	SO[301]	5520.5	105.5	644	SO[359]	4534.5	245.5
471	SO[186]	7475.5	385.5	529	SO[244]	6489.5	105.5	587	SO[302]	5503.5	245.5	645	SO[360]	4517.5	385.5
472	SO[187]	7458.5	105.5	530	SO[245]	6472.5	245.5	588	SO[303]	5486.5	385.5	646	SO[361]	4500.5	105.5
473	SO[188]	7441.5	245.5	531	SO[246]	6455.5	385.5	589	SO[304]	5469.5	105.5	647	SO[362]	4483.5	245.5
474	SO[189]	7424.5	385.5	532	SO[247]	6438.5	105.5	590	SO[305]	5452.5	245.5	648	SO[363]	4466.5	385.5
475	SO[190]	7407.5	105.5	533	SO[248]	6421.5	245.5	591	SO[306]	5435.5	385.5	649	SO[364]	4449.5	105.5
476	SO[191]	7390.5	245.5	534	SO[249]	6404.5	385.5	592	SO[307]	5418.5	105.5	650	SO[365]	4432.5	245.5
477	SO[192]	7373.5	385.5	535	SO[250]	6387.5	105.5	593	SO[308]	5401.5	245.5	651	SO[366]	4415.5	385.5
478	SO[193]	7356.5	105.5	536	SO[251]	6370.5	245.5	594	SO[309]	5384.5	385.5	652	SO[367]	4398.5	105.5
479	SO[194]	7339.5	245.5	537	SO[252]	6353.5	385.5	595	SO[310]	5367.5	105.5	653	SO[368]	4381.5	245.5
480	SO[195]	7322.5	385.5	538	SO[253]	6336.5	105.5	596	SO[311]	5350.5	245.5	654	SO[369]	4364.5	385.5
481	SO[196]	7305.5	105.5	539	SO[254]	6319.5	245.5	597	SO[312]	5333.5	385.5	655	SO[370]	4347.5	105.5
482	SO[197]	7288.5	245.5	540	SO[255]	6302.5	385.5	598	SO[313]	5316.5	105.5	656	SO[371]	4330.5	245.5
483	SO[198]	7271.5	385.5	541	SO[256]	6285.5	105.5	599	SO[314]	5299.5	245.5	657	SO[372]	4313.5	385.5
484	SO[199]	7254.5	105.5	542	SO[257]	6268.5	245.5	600	SO[315]	5282.5	385.5	658	SO[373]	4296.5	105.5
485	SO[200]	7237.5	245.5	543	SO[258]	6251.5	385.5	601	SO[316]	5265.5	105.5	659	SO[374]	4279.5	245.5
486	SO[201]	7220.5	385.5	544	SO[259]	6234.5	105.5	602	SO[317]	5248.5	245.5	660	SO[375]	4262.5	385.5
487	SO[202]	7203.5	105.5	545	SO[260]	6217.5	245.5	603	SO[318]	5231.5	385.5	661	SO[376]	4245.5	105.5
488	SO[203]	7186.5	245.5	546	SO[261]	6200.5	385.5	604	SO[319]	5214.5	105.5	662	SO[377]	4228.5	245.5
489	SO[204]	7169.5	385.5	547	SO[262]	6183.5	105.5	605	SO[320]	5197.5	245.5	663	SO[378]	4211.5	385.5
490	SO[205]	7152.5	105.5	548	SO[263]	6166.5	245.5	606	SO[321]	5180.5	385.5	664	SO[379]	4194.5	105.5
491	SO[206]	7135.5	245.5	549	SO[264]	6149.5	385.5	607	SO[322]	5163.5	105.5	665	SO[380]	4177.5	245.5
492	SO[207]	7118.5	385.5	550	SO[265]	6132.5	105.5	608	SO[323]	5146.5	245.5	666	SO[381]	4160.5	385.5
493	SO[208]	7101.5	105.5	551	SO[266]	6115.5	245.5	609	SO[324]	5129.5	385.5	667	SO[382]	4143.5	105.5
494	SO[209]	7084.5	245.5	552	SO[267]	6098.5	385.5	610	SO[325]	5112.5	105.5	668	SO[383]	4126.5	245.5
495	SO[210]	7067.5	385.5	553	SO[268]	6081.5	105.5	611	SO[326]	5095.5	245.5	669	SO[384]	4109.5	385.5
496	SO[211]	7050.5	105.5	554	SO[269]	6064.5	245.5	612	SO[327]	5078.5	385.5	670	SO[385]	4092.5	105.5
497	SO[212]	7033.5	245.5	555	SO[270]	6047.5	385.5	613	SO[328]	5061.5	105.5	671	SO[386]	4075.5	245.5
498	SO[213]	7016.5	385.5	556	SO[271]	6030.5	105.5	614	SO[329]	5044.5	245.5	672	SO[387]	4058.5	385.5
499	SO[214]	6999.5	105.5	557	SO[272]	6013.5	245.5	615	SO[330]	5027.5	385.5	673	SO[388]	4041.5	105.5
500	SO[215]	6982.5	245.5	558	SO[273]	5996.5	385.5	616	SO[331]	5010.5	105.5	674	SO[389]	4024.5	245.5
501	SO[216]	6965.5	385.5	559	SO[274]	5979.5	105.5	617	SO[332]	4993.5	245.5	675	SO[390]	4007.5	385.5
502	SO[217]	6948.5	105.5	560	SO[275]	5962.5	245.5	618	SO[333]	4976.5	385.5	676	SO[391]	3990.5	105.5
503	SO[218]	6931.5	245.5	561	SO[276]	5945.5	385.5	619	SO[334]	4959.5	105.5	677	SO[392]	3973.5	245.5
504	SO[219]	6914.5	385.5	562	SO[277]	5928.5	105.5	620	SO[335]	4942.5	245.5	678	SO[393]	3956.5	385.5
505	SO[220]	6897.5	105.5	563	SO[278]	5911.5	245.5	621	SO[336]	4925.5	385.5	679	SO[394]	3939.5	105.5
506	SO[221]	6880.5	245.5	564	SO[279]	5894.5	385.5	622	SO[337]	4908.5	105.5	680	SO[395]	3922.5	245.5
507	SO[222]	6863.5	385.5	565	SO[280]	5877.5	105.5	623	SO[338]	4891.5	245.5	681	SO[396]	3905.5	385.5
508	SO[223]	6846.5	105.5	566	SO[281]	5860.5	245.5	624	SO[339]	4874.5	385.5	682	SO[397]	3888.5	105.5
509	SO[224]	6829.5	245.5	567	SO[282]	5843.5	385.5	625	SO[340]	4857.5	105.5	683	SO[398]	3871.5	245.5
510	SO[225]	6812.5	385.5	568	SO[283]	5826.5	105.5	626	SO[341]	4840.5	245.5	684	SO[399]	3854.5	385.5
511	SO[226]	6795.5	105.5	569	SO[284]	5809.5	245.5	627	SO[342]	4823.5	385.5	685	SO[400]	3837.5	105.5
512	SO[227]	6778.5	245.5	570	SO[285]	5792.5	385.5	628	SO[343]	4806.5	105.5	686	SO[401]	3820.5	245.5
513	SO[228]	6761.5	385.5	571	SO[286]	5775.5	105.5	629	SO[344]	4789.5	245.5	687	SO[402]	3803.5	385.5
514	SO[229]	6744.5	105.5	572	SO[287]	5758.5	245.5	630	SO[345]	4772.5	385.5	688	SO[403]	3786.5	105.5
515	SO[230]	6727.5	245.5	573	SO[288]	5741.5	385.5	631	SO[346]	4755.5	105.5	689	SO[404]	3769.5	245.5
516	SO[231]	6710.5	385.5	574	SO[289]	5724.5	105.5	632	SO[347]	4738.5	245.5	690	SO[405]	3752.5	385.5
517	SO[232]	6693.5	105.5	575	SO[290]	5707.5	245.5	633	SO[348]	4721.5	385.5	691	SO[406]	3735.5	105.5
518	SO[233]	6676.5	245.5	576	SO[291]	5690.5	385.5	634	SO[349]	4704.5	105.5	692	SO[407]	3718.5	245.5
519	SO[234]	6659.5	385.5	577	SO[292]	5673.5	105.5	635	SO[350]	4687.5	245.5	693	SO[408]	3701.5	385.5
520	SO[235]	6642.5	105.5	578	SO[293]	5656.5	245.5	636	SO[351]	4670.5	385.5	694	SO[409]	3684.5	105.5
521	SO[236]	6625.5	245.5	579	SO[294]	5639.5	385.5	637	SO[352]	4653.5	105.5	695	SO[410]	3667.5	245.5
522	SO[237]	6608.5	385.5	580	SO[295]	5622.5	105.5	638	SO[353]	4636.5	245.5	696	SO[411]	3650.5	385.5

No.	Pad name	X	Y	No.	Pad name	X	Y	No.	Pad name	X	Y	No.	Pad name	X	Y
697	SO[412]	3633.5	105.5	755	SO[470]	2647.5	245.5	813	SO[528]	1661.5	385.5	871	SO[586]	675.5	105.5
698	SO[413]	3616.5	245.5	756	SO[471]	2630.5	385.5	814	SO[529]	1644.5	105.5	872	SO[587]	658.5	245.5
699	SO[414]	3599.5	385.5	757	SO[472]	2613.5	105.5	815	SO[530]	1627.5	245.5	873	SO[588]	641.5	385.5
700	SO[415]	3582.5	105.5	758	SO[473]	2596.5	245.5	816	SO[531]	1610.5	385.5	874	SO[589]	624.5	105.5
701	SO[416]	3565.5	245.5	759	SO[474]	2579.5	385.5	817	SO[532]	1593.5	105.5	875	SO[590]	607.5	245.5
702	SO[417]	3548.5	385.5	760	SO[475]	2562.5	105.5	818	SO[533]	1576.5	245.5	876	SO[591]	590.5	385.5
703	SO[418]	3531.5	105.5	761	SO[476]	2545.5	245.5	819	SO[534]	1559.5	385.5	877	SO[592]	573.5	105.5
704	SO[419]	3514.5	245.5	762	SO[477]	2528.5	385.5	820	SO[535]	1542.5	105.5	878	SO[593]	556.5	245.5
705	SO[420]	3497.5	385.5	763	SO[478]	2511.5	105.5	821	SO[536]	1525.5	245.5	879	SO[594]	539.5	385.5
706	SO[421]	3480.5	105.5	764	SO[479]	2494.5	245.5	822	SO[537]	1508.5	385.5	880	SO[595]	522.5	105.5
707	SO[422]	3463.5	245.5	765	SO[480]	2477.5	385.5	823	SO[538]	1491.5	105.5	881	SO[596]	505.5	245.5
708	SO[423]	3446.5	385.5	766	SO[481]	2460.5	105.5	824	SO[539]	1474.5	245.5	882	SO[597]	488.5	385.5
709	SO[424]	3429.5	105.5	767	SO[482]	2443.5	245.5	825	SO[540]	1457.5	385.5	883	SO[598]	471.5	105.5
710	SO[425]	3412.5	245.5	768	SO[483]	2426.5	385.5	826	SO[541]	1440.5	105.5	884	SO[599]	454.5	245.5
711	SO[426]	3395.5	385.5	769	SO[484]	2409.5	105.5	827	SO[542]	1423.5	245.5	885	SO[600]	437.5	385.5
712	SO[427]	3378.5	105.5	770	SO[485]	2392.5	245.5	828	SO[543]	1406.5	385.5	886	SHIELDING	403.5	385.5
713	SO[428]	3361.5	245.5	771	SO[486]	2375.5	385.5	829	SO[544]	1389.5	105.5	887	SHIELDING	369.5	385.5
714	SO[429]	3344.5	385.5	772	SO[487]	2358.5	105.5	830	SO[545]	1372.5	245.5	888	SHIELDING	335.5	385.5
715	SO[430]	3327.5	105.5	773	SO[488]	2341.5	245.5	831	SO[546]	1355.5	385.5	889	SHIELDING	301.5	385.5
716	SO[431]	3310.5	245.5	774	SO[489]	2324.5	385.5	832	SO[547]	1338.5	105.5	890	SHIELDING	267.5	385.5
717	SO[432]	3293.5	385.5	775	SO[490]	2307.5	105.5	833	SO[548]	1321.5	245.5	891	SHIELDING	233.5	385.5
718	SO[433]	3276.5	105.5	776	SO[491]	2290.5	245.5	834	SO[549]	1304.5	385.5	892	SHIELDING	-233.5	385.5
719	SO[434]	3259.5	245.5	777	SO[492]	2273.5	385.5	835	SO[550]	1287.5	105.5	893	SHIELDING	-267.5	385.5
720	SO[435]	3242.5	385.5	778	SO[493]	2256.5	105.5	836	SO[551]	1270.5	245.5	894	SHIELDING	-301.5	385.5
721	SO[436]	3225.5	105.5	779	SO[494]	2239.5	245.5	837	SO[552]	1253.5	385.5	895	SHIELDING	-335.5	385.5
722	SO[437]	3208.5	245.5	780	SO[495]	2222.5	385.5	838	SO[553]	1236.5	105.5	896	SHIELDING	-369.5	385.5
723	SO[438]	3191.5	385.5	781	SO[496]	2205.5	105.5	839	SO[554]	1219.5	245.5	897	SHIELDING	-403.5	385.5
724	SO[439]	3174.5	105.5	782	SO[497]	2188.5	245.5	840	SO[555]	1202.5	385.5	898	SO[601]	-437.5	385.5
725	SO[440]	3157.5	245.5	783	SO[498]	2171.5	385.5	841	SO[556]	1185.5	105.5	899	SO[602]	-454.5	245.5
726	SO[441]	3140.5	385.5	784	SO[499]	2154.5	105.5	842	SO[557]	1168.5	245.5	900	SO[603]	-471.5	105.5
727	SO[442]	3123.5	105.5	785	SO[500]	2137.5	245.5	843	SO[558]	1151.5	385.5	901	SO[604]	-488.5	385.5
728	SO[443]	3106.5	245.5	786	SO[501]	2120.5	385.5	844	SO[559]	1134.5	105.5	902	SO[605]	-505.5	245.5
729	SO[444]	3089.5	385.5	787	SO[502]	2103.5	105.5	845	SO[560]	1117.5	245.5	903	SO[606]	-522.5	105.5
730	SO[445]	3072.5	105.5	788	SO[503]	2086.5	245.5	846	SO[561]	1100.5	385.5	904	SO[607]	-539.5	385.5
731	SO[446]	3055.5	245.5	789	SO[504]	2069.5	385.5	847	SO[562]	1083.5	105.5	905	SO[608]	-556.5	245.5
732	SO[447]	3038.5	385.5	790	SO[505]	2052.5	105.5	848	SO[563]	1066.5	245.5	906	SO[609]	-573.5	105.5
733	SO[448]	3021.5	105.5	791	SO[506]	2035.5	245.5	849	SO[564]	1049.5	385.5	907	SO[610]	-590.5	385.5
734	SO[449]	3004.5	245.5	792	SO[507]	2018.5	385.5	850	SO[565]	1032.5	105.5	908	SO[611]	-607.5	245.5
735	SO[450]	2987.5	385.5	793	SO[508]	2001.5	105.5	851	SO[566]	1015.5	245.5	909	SO[612]	-624.5	105.5
736	SO[451]	2970.5	105.5	794	SO[509]	1984.5	245.5	852	SO[567]	998.5	385.5	910	SO[613]	-641.5	385.5
737	SO[452]	2953.5	245.5	795	SO[510]	1967.5	385.5	853	SO[568]	981.5	105.5	911	SO[614]	-658.5	245.5
738	SO[453]	2936.5	385.5	796	SO[511]	1950.5	105.5	854	SO[569]	964.5	245.5	912	SO[615]	-675.5	105.5
739	SO[454]	2919.5	105.5	797	SO[512]	1933.5	245.5	855	SO[570]	947.5	385.5	913	SO[616]	-692.5	385.5
740	SO[455]	2902.5	245.5	798	SO[513]	1916.5	385.5	856	SO[571]	930.5	105.5	914	SO[617]	-709.5	245.5
741	SO[456]	2885.5	385.5	799	SO[514]	1899.5	105.5	857	SO[572]	913.5	245.5	915	SO[618]	-726.5	105.5
742	SO[457]	2868.5	105.5	800	SO[515]	1882.5	245.5	858	SO[573]	896.5	385.5	916	SO[619]	-743.5	385.5
743	SO[458]	2851.5	245.5	801	SO[516]	1865.5	385.5	859	SO[574]	879.5	105.5	917	SO[620]	-760.5	245.5
744	SO[459]	2834.5	385.5	802	SO[517]	1848.5	105.5	860	SO[575]	862.5	245.5	918	SO[621]	-777.5	105.5
745	SO[460]	2817.5	105.5	803	SO[518]	1831.5	245.5	861	SO[576]	845.5	385.5	919	SO[622]	-794.5	385.5
746	SO[461]	2800.5	245.5	804	SO[519]	1814.5	385.5	862	SO[577]	828.5	105.5	920	SO[623]	-811.5	245.5
747	SO[462]	2783.5	385.5	805	SO[520]	1797.5	105.5	863	SO[578]	811.5	245.5	921	SO[624]	-828.5	105.5
748	SO[463]	2766.5	105.5	806	SO[521]	1780.5	245.5	864	SO[579]	794.5	385.5	922	SO[625]	-845.5	385.5
749	SO[464]	2749.5	245.5	807	SO[522]	1763.5	385.5	865	SO[580]	777.5	105.5	923	SO[626]	-862.5	245.5
750	SO[465]	2732.5	385.5	808	SO[523]	1746.5	105.5	866	SO[581]	760.5	245.5	924	SO[627]	-879.5	105.5
751	SO[466]	2715.5	105.5	809	SO[524]	1729.5	245.5	867	SO[582]	743.5	385.5	925	SO[628]	-896.5	385.5
752	SO[467]	2698.5	245.5	810	SO[525]	1712.5	385.5	868	SO[583]	726.5	105.5	926	SO[629]	-913.5	245.5
753	SO[468]	2681.5	385.5	811	SO[526]	1695.5	105.5	869	SO[584]	709.5	245.5	927	SO[630]	-930.5	105.5
754	SO[469]	2664.5	105.5	812	SO[527]	1678.5	245.5	870	SO[585]	692.5	385.5	928	SO[631]	-947.5	385.5

No.	Pad name	X	Y	No.	Pad name	X	Y	No.	Pad name	X	Y	No.	Pad name	X	Y
929	SO[632]	-964.5	245.5	987	SO[690]	-1950.5	105.5	1045	SO[748]	-2936.5	385.5	1103	SO[806]	-3922.5	245.5
930	SO[633]	-981.5	105.5	988	SO[691]	-1967.5	385.5	1046	SO[749]	-2953.5	245.5	1104	SO[807]	-3939.5	105.5
931	SO[634]	-998.5	385.5	989	SO[692]	-1984.5	245.5	1047	SO[750]	-2970.5	105.5	1105	SO[808]	-3956.5	385.5
932	SO[635]	-1015.5	245.5	990	SO[693]	-2001.5	105.5	1048	SO[751]	-2987.5	385.5	1106	SO[809]	-3973.5	245.5
933	SO[636]	-1032.5	105.5	991	SO[694]	-2018.5	385.5	1049	SO[752]	-3004.5	245.5	1107	SO[810]	-3990.5	105.5
934	SO[637]	-1049.5	385.5	992	SO[695]	-2035.5	245.5	1050	SO[753]	-3021.5	105.5	1108	SO[811]	-4007.5	385.5
935	SO[638]	-1066.5	245.5	993	SO[696]	-2052.5	105.5	1051	SO[754]	-3038.5	385.5	1109	SO[812]	-4024.5	245.5
936	SO[639]	-1083.5	105.5	994	SO[697]	-2069.5	385.5	1052	SO[755]	-3055.5	245.5	1110	SO[813]	-4041.5	105.5
937	SO[640]	-1100.5	385.5	995	SO[698]	-2086.5	245.5	1053	SO[756]	-3072.5	105.5	1111	SO[814]	-4058.5	385.5
938	SO[641]	-1117.5	245.5	996	SO[699]	-2103.5	105.5	1054	SO[757]	-3089.5	385.5	1112	SO[815]	-4075.5	245.5
939	SO[642]	-1134.5	105.5	997	SO[700]	-2120.5	385.5	1055	SO[758]	-3106.5	245.5	1113	SO[816]	-4092.5	105.5
940	SO[643]	-1151.5	385.5	998	SO[701]	-2137.5	245.5	1056	SO[759]	-3123.5	105.5	1114	SO[817]	-4109.5	385.5
941	SO[644]	-1168.5	245.5	999	SO[702]	-2154.5	105.5	1057	SO[760]	-3140.5	385.5	1115	SO[818]	-4126.5	245.5
942	SO[645]	-1185.5	105.5	1000	SO[703]	-2171.5	385.5	1058	SO[761]	-3157.5	245.5	1116	SO[819]	-4143.5	105.5
943	SO[646]	-1202.5	385.5	1001	SO[704]	-2188.5	245.5	1059	SO[762]	-3174.5	105.5	1117	SO[820]	-4160.5	385.5
944	SO[647]	-1219.5	245.5	1002	SO[705]	-2205.5	105.5	1060	SO[763]	-3191.5	385.5	1118	SO[821]	-4177.5	245.5
945	SO[648]	-1236.5	105.5	1003	SO[706]	-2222.5	385.5	1061	SO[764]	-3208.5	245.5	1119	SO[822]	-4194.5	105.5
946	SO[649]	-1253.5	385.5	1004	SO[707]	-2239.5	245.5	1062	SO[765]	-3225.5	105.5	1120	SO[823]	-4211.5	385.5
947	SO[650]	-1270.5	245.5	1005	SO[708]	-2256.5	105.5	1063	SO[766]	-3242.5	385.5	1121	SO[824]	-4228.5	245.5
948	SO[651]	-1287.5	105.5	1006	SO[709]	-2273.5	385.5	1064	SO[767]	-3259.5	245.5	1122	SO[825]	-4245.5	105.5
949	SO[652]	-1304.5	385.5	1007	SO[710]	-2290.5	245.5	1065	SO[768]	-3276.5	105.5	1123	SO[826]	-4262.5	385.5
950	SO[653]	-1321.5	245.5	1008	SO[711]	-2307.5	105.5	1066	SO[769]	-3293.5	385.5	1124	SO[827]	-4279.5	245.5
951	SO[654]	-1338.5	105.5	1009	SO[712]	-2324.5	385.5	1067	SO[770]	-3310.5	245.5	1125	SO[828]	-4296.5	105.5
952	SO[655]	-1355.5	385.5	1010	SO[713]	-2341.5	245.5	1068	SO[771]	-3327.5	105.5	1126	SO[829]	-4313.5	385.5
953	SO[656]	-1372.5	245.5	1011	SO[714]	-2358.5	105.5	1069	SO[772]	-3344.5	385.5	1127	SO[830]	-4330.5	245.5
954	SO[657]	-1389.5	105.5	1012	SO[715]	-2375.5	385.5	1070	SO[773]	-3361.5	245.5	1128	SO[831]	-4347.5	105.5
955	SO[658]	-1406.5	385.5	1013	SO[716]	-2392.5	245.5	1071	SO[774]	-3378.5	105.5	1129	SO[832]	-4364.5	385.5
956	SO[659]	-1423.5	245.5	1014	SO[717]	-2409.5	105.5	1072	SO[775]	-3395.5	385.5	1130	SO[833]	-4381.5	245.5
957	SO[660]	-1440.5	105.5	1015	SO[718]	-2426.5	385.5	1073	SO[776]	-3412.5	245.5	1131	SO[834]	-4398.5	105.5
958	SO[661]	-1457.5	385.5	1016	SO[719]	-2443.5	245.5	1074	SO[777]	-3429.5	105.5	1132	SO[835]	-4415.5	385.5
959	SO[662]	-1474.5	245.5	1017	SO[720]	-2460.5	105.5	1075	SO[778]	-3446.5	385.5	1133	SO[836]	-4432.5	245.5
960	SO[663]	-1491.5	105.5	1018	SO[721]	-2477.5	385.5	1076	SO[779]	-3463.5	245.5	1134	SO[837]	-4449.5	105.5
961	SO[664]	-1508.5	385.5	1019	SO[722]	-2494.5	245.5	1077	SO[780]	-3480.5	105.5	1135	SO[838]	-4466.5	385.5
962	SO[665]	-1525.5	245.5	1020	SO[723]	-2511.5	105.5	1078	SO[781]	-3497.5	385.5	1136	SO[839]	-4483.5	245.5
963	SO[666]	-1542.5	105.5	1021	SO[724]	-2528.5	385.5	1079	SO[782]	-3514.5	245.5	1137	SO[840]	-4500.5	105.5
964	SO[667]	-1559.5	385.5	1022	SO[725]	-2545.5	245.5	1080	SO[783]	-3531.5	105.5	1138	SO[841]	-4517.5	385.5
965	SO[668]	-1576.5	245.5	1023	SO[726]	-2562.5	105.5	1081	SO[784]	-3548.5	385.5	1139	SO[842]	-4534.5	245.5
966	SO[669]	-1593.5	105.5	1024	SO[727]	-2579.5	385.5	1082	SO[785]	-3565.5	245.5	1140	SO[843]	-4551.5	105.5
967	SO[670]	-1610.5	385.5	1025	SO[728]	-2596.5	245.5	1083	SO[786]	-3582.5	105.5	1141	SO[844]	-4568.5	385.5
968	SO[671]	-1627.5	245.5	1026	SO[729]	-2613.5	105.5	1084	SO[787]	-3599.5	385.5	1142	SO[845]	-4585.5	245.5
969	SO[672]	-1644.5	105.5	1027	SO[730]	-2630.5	385.5	1085	SO[788]	-3616.5	245.5	1143	SO[846]	-4602.5	105.5
970	SO[673]	-1661.5	385.5	1028	SO[731]	-2647.5	245.5	1086	SO[789]	-3633.5	105.5	1144	SO[847]	-4619.5	385.5
971	SO[674]	-1678.5	245.5	1029	SO[732]	-2664.5	105.5	1087	SO[790]	-3650.5	385.5	1145	SO[848]	-4636.5	245.5
972	SO[675]	-1695.5	105.5	1030	SO[733]	-2681.5	385.5	1088	SO[791]	-3667.5	245.5	1146	SO[849]	-4653.5	105.5
973	SO[676]	-1712.5	385.5	1031	SO[734]	-2698.5	245.5	1089	SO[792]	-3684.5	105.5	1147	SO[850]	-4670.5	385.5
974	SO[677]	-1729.5	245.5	1032	SO[735]	-2715.5	105.5	1090	SO[793]	-3701.5	385.5	1148	SO[851]	-4687.5	245.5
975	SO[678]	-1746.5	105.5	1033	SO[736]	-2732.5	385.5	1091	SO[794]	-3718.5	245.5	1149	SO[852]	-4704.5	105.5
976	SO[679]	-1763.5	385.5	1034	SO[737]	-2749.5	245.5	1092	SO[795]	-3735.5	105.5	1150	SO[853]	-4721.5	385.5
977	SO[680]	-1780.5	245.5	1035	SO[738]	-2766.5	105.5	1093	SO[796]	-3752.5	385.5	1151	SO[854]	-4738.5	245.5
978	SO[681]	-1797.5	105.5	1036	SO[739]	-2783.5	385.5	1094	SO[797]	-3769.5	245.5	1152	SO[855]	-4755.5	105.5
979	SO[682]	-1814.5	385.5	1037	SO[740]	-2800.5	245.5	1095	SO[798]	-3786.5	105.5	1153	SO[856]	-4772.5	385.5
980	SO[683]	-1831.5	245.5	1038	SO[741]	-2817.5	105.5	1096	SO[799]	-3803.5	385.5	1154	SO[857]	-4789.5	245.5
981	SO[684]	-1848.5	105.5	1039	SO[742]	-2834.5	385.5	1097	SO[800]	-3820.5	245.5	1155	SO[858]	-4806.5	105.5
982	SO[685]	-1865.5	385.5	1040	SO[743]	-2851.5	245.5	1098	SO[801]	-3837.5	105.5	1156	SO[859]	-4823.5	385.5
983	SO[686]	-1882.5	245.5	1041	SO[744]	-2868.5	105.5	1099	SO[802]	-3854.5	385.5	1157	SO[860]	-4840.5	245.5
984	SO[687]	-1899.5	105.5	1042	SO[745]	-2885.5	385.5	1100	SO[803]	-3871.5	245.5	1158	SO[861]	-4857.5	105.5
985	SO[688]	-1916.5	385.5	1043	SO[746]	-2902.5	245.5	1101	SO[804]	-3888.5	105.5	1159	SO[862]	-4874.5	385.5
986	SO[689]	-1933.5	245.5	1044	SO[747]	-2919.5	105.5	1102	SO[805]	-3905.5	385.5	1160	SO[863]	-4891.5	245.5

No.	Pad name	X	Y	No.	Pad name	X	Y	No.	Pad name	X	Y	No.	Pad name	X	Y
1161	SO[864]	-4908.5	105.5	1219	SO[922]	-5894.5	385.5	1277	SO[980]	-6880.5	245.5	1335	SO[1038]	-7866.5	105.5
1162	SO[865]	-4925.5	385.5	1220	SO[923]	-5911.5	245.5	1278	SO[981]	-6897.5	105.5	1336	SO[1039]	-7883.5	385.5
1163	SO[866]	-4942.5	245.5	1221	SO[924]	-5928.5	105.5	1279	SO[982]	-6914.5	385.5	1337	SO[1040]	-7900.5	245.5
1164	SO[867]	-4959.5	105.5	1222	SO[925]	-5945.5	385.5	1280	SO[983]	-6931.5	245.5	1338	SO[1041]	-7917.5	105.5
1165	SO[868]	-4976.5	385.5	1223	SO[926]	-5962.5	245.5	1281	SO[984]	-6948.5	105.5	1339	SO[1042]	-7934.5	385.5
1166	SO[869]	-4993.5	245.5	1224	SO[927]	-5979.5	105.5	1282	SO[985]	-6965.5	385.5	1340	SO[1043]	-7951.5	245.5
1167	SO[870]	-5010.5	105.5	1225	SO[928]	-5996.5	385.5	1283	SO[986]	-6982.5	245.5	1341	SO[1044]	-7968.5	105.5
1168	SO[871]	-5027.5	385.5	1226	SO[929]	-6013.5	245.5	1284	SO[987]	-6999.5	105.5	1342	SO[1045]	-7985.5	385.5
1169	SO[872]	-5044.5	245.5	1227	SO[930]	-6030.5	105.5	1285	SO[988]	-7016.5	385.5	1343	SO[1046]	-8002.5	245.5
1170	SO[873]	-5061.5	105.5	1228	SO[931]	-6047.5	385.5	1286	SO[989]	-7033.5	245.5	1344	SO[1047]	-8019.5	105.5
1171	SO[874]	-5078.5	385.5	1229	SO[932]	-6064.5	245.5	1287	SO[990]	-7050.5	105.5	1345	SO[1048]	-8036.5	385.5
1172	SO[875]	-5095.5	245.5	1230	SO[933]	-6081.5	105.5	1288	SO[991]	-7067.5	385.5	1346	SO[1049]	-8053.5	245.5
1173	SO[876]	-5112.5	105.5	1231	SO[934]	-6098.5	385.5	1289	SO[992]	-7084.5	245.5	1347	SO[1050]	-8070.5	105.5
1174	SO[877]	-5129.5	385.5	1232	SO[935]	-6115.5	245.5	1290	SO[993]	-7101.5	105.5	1348	SO[1051]	-8087.5	385.5
1175	SO[878]	-5146.5	245.5	1233	SO[936]	-6132.5	105.5	1291	SO[994]	-7118.5	385.5	1349	SO[1052]	-8104.5	245.5
1176	SO[879]	-5163.5	105.5	1234	SO[937]	-6149.5	385.5	1292	SO[995]	-7135.5	245.5	1350	SO[1053]	-8121.5	105.5
1177	SO[880]	-5180.5	385.5	1235	SO[938]	-6166.5	245.5	1293	SO[996]	-7152.5	105.5	1351	SO[1054]	-8138.5	385.5
1178	SO[881]	-5197.5	245.5	1236	SO[939]	-6183.5	105.5	1294	SO[997]	-7169.5	385.5	1352	SO[1055]	-8155.5	245.5
1179	SO[882]	-5214.5	105.5	1237	SO[940]	-6200.5	385.5	1295	SO[998]	-7186.5	245.5	1353	SO[1056]	-8172.5	105.5
1180	SO[883]	-5231.5	385.5	1238	SO[941]	-6217.5	245.5	1296	SO[999]	-7203.5	105.5	1354	SO[1057]	-8189.5	385.5
1181	SO[884]	-5248.5	245.5	1239	SO[942]	-6234.5	105.5	1297	SO[1000]	-7220.5	385.5	1355	SO[1058]	-8206.5	245.5
1182	SO[885]	-5265.5	105.5	1240	SO[943]	-6251.5	385.5	1298	SO[1001]	-7237.5	245.5	1356	SO[1059]	-8223.5	105.5
1183	SO[886]	-5282.5	385.5	1241	SO[944]	-6268.5	245.5	1299	SO[1002]	-7254.5	105.5	1357	SO[1060]	-8240.5	385.5
1184	SO[887]	-5299.5	245.5	1242	SO[945]	-6285.5	105.5	1300	SO[1003]	-7271.5	385.5	1358	SO[1061]	-8257.5	245.5
1185	SO[888]	-5316.5	105.5	1243	SO[946]	-6302.5	385.5	1301	SO[1004]	-7288.5	245.5	1359	SO[1062]	-8274.5	105.5
1186	SO[889]	-5333.5	385.5	1244	SO[947]	-6319.5	245.5	1302	SO[1005]	-7305.5	105.5	1360	SO[1063]	-8291.5	385.5
1187	SO[890]	-5350.5	245.5	1245	SO[948]	-6336.5	105.5	1303	SO[1006]	-7322.5	385.5	1361	SO[1064]	-8308.5	245.5
1188	SO[891]	-5367.5	105.5	1246	SO[949]	-6353.5	385.5	1304	SO[1007]	-7339.5	245.5	1362	SO[1065]	-8325.5	105.5
1189	SO[892]	-5384.5	385.5	1247	SO[950]	-6370.5	245.5	1305	SO[1008]	-7356.5	105.5	1363	SO[1066]	-8342.5	385.5
1190	SO[893]	-5401.5	245.5	1248	SO[951]	-6387.5	105.5	1306	SO[1009]	-7373.5	385.5	1364	SO[1067]	-8359.5	245.5
1191	SO[894]	-5418.5	105.5	1249	SO[952]	-6404.5	385.5	1307	SO[1010]	-7390.5	245.5	1365	SO[1068]	-8376.5	105.5
1192	SO[895]	-5435.5	385.5	1250	SO[953]	-6421.5	245.5	1308	SO[1011]	-7407.5	105.5	1366	SO[1069]	-8393.5	385.5
1193	SO[896]	-5452.5	245.5	1251	SO[954]	-6438.5	105.5	1309	SO[1012]	-7424.5	385.5	1367	SO[1070]	-8410.5	245.5
1194	SO[897]	-5469.5	105.5	1252	SO[955]	-6455.5	385.5	1310	SO[1013]	-7441.5	245.5	1368	SO[1071]	-8427.5	105.5
1195	SO[898]	-5486.5	385.5	1253	SO[956]	-6472.5	245.5	1311	SO[1014]	-7458.5	105.5	1369	SO[1072]	-8444.5	385.5
1196	SO[899]	-5503.5	245.5	1254	SO[957]	-6489.5	105.5	1312	SO[1015]	-7475.5	385.5	1370	SO[1073]	-8461.5	245.5
1197	SO[900]	-5520.5	105.5	1255	SO[958]	-6506.5	385.5	1313	SO[1016]	-7492.5	245.5	1371	SO[1074]	-8478.5	105.5
1198	SO[901]	-5537.5	385.5	1256	SO[959]	-6523.5	245.5	1314	SO[1017]	-7509.5	105.5	1372	SO[1075]	-8495.5	385.5
1199	SO[902]	-5554.5	245.5	1257	SO[960]	-6540.5	105.5	1315	SO[1018]	-7526.5	385.5	1373	SO[1076]	-8512.5	245.5
1200	SO[903]	-5571.5	105.5	1258	SO[961]	-6557.5	385.5	1316	SO[1019]	-7543.5	245.5	1374	SO[1077]	-8529.5	105.5
1201	SO[904]	-5588.5	385.5	1259	SO[962]	-6574.5	245.5	1317	SO[1020]	-7560.5	105.5	1375	SO[1078]	-8546.5	385.5
1202	SO[905]	-5605.5	245.5	1260	SO[963]	-6591.5	105.5	1318	SO[1021]	-7577.5	385.5	1376	SO[1079]	-8563.5	245.5
1203	SO[906]	-5622.5	105.5	1261	SO[964]	-6608.5	385.5	1319	SO[1022]	-7594.5	245.5	1377	SO[1080]	-8580.5	105.5
1204	SO[907]	-5639.5	385.5	1262	SO[965]	-6625.5	245.5	1320	SO[1023]	-7611.5	105.5	1378	SO[1081]	-8597.5	385.5
1205	SO[908]	-5656.5	245.5	1263	SO[966]	-6642.5	105.5	1321	SO[1024]	-7628.5	385.5	1379	SO[1082]	-8614.5	245.5
1206	SO[909]	-5673.5	105.5	1264	SO[967]	-6659.5	385.5	1322	SO[1025]	-7645.5	245.5	1380	SO[1083]	-8631.5	105.5
1207	SO[910]	-5690.5	385.5	1265	SO[968]	-6676.5	245.5	1323	SO[1026]	-7662.5	105.5	1381	SO[1084]	-8648.5	385.5
1208	SO[911]	-5707.5	245.5	1266	SO[969]	-6693.5	105.5	1324	SO[1027]	-7679.5	385.5	1382	SO[1085]	-8665.5	245.5
1209	SO[912]	-5724.5	105.5	1267	SO[970]	-6710.5	385.5	1325	SO[1028]	-7696.5	245.5	1383	SO[1086]	-8682.5	105.5
1210	SO[913]	-5741.5	385.5	1268	SO[971]	-6727.5	245.5	1326	SO[1029]	-7713.5	105.5	1384	SO[1087]	-8699.5	385.5
1211	SO[914]	-5758.5	245.5	1269	SO[972]	-6744.5	105.5	1327	SO[1030]	-7730.5	385.5	1385	SO[1088]	-8716.5	245.5
1212	SO[915]	-5775.5	105.5	1270	SO[973]	-6761.5	385.5	1328	SO[1031]	-7747.5	245.5	1386	SO[1089]	-8733.5	105.5
1213	SO[916]	-5792.5	385.5	1271	SO[974]	-6778.5	245.5	1329	SO[1032]	-7764.5	105.5	1387	SO[1090]	-8750.5	385.5
1214	SO[917]	-5809.5	245.5	1272	SO[975]	-6795.5	105.5	1330	SO[1033]	-7781.5	385.5	1388	SO[1091]	-8767.5	245.5
1215	SO[918]	-5826.5	105.5	1273	SO[976]	-6812.5	385.5	1331	SO[1034]	-7798.5	245.5	1389	SO[1092]	-8784.5	105.5
1216	SO[919]	-5843.5	385.5	1274	SO[977]	-6829.5	245.5	1332	SO[1035]	-7815.5	105.5	1390	SO[1093]	-8801.5	385.5
1217	SO[920]	-5860.5	245.5	1275	SO[978]	-6846.5	105.5	1333	SO[1036]	-7832.5	385.5	1391	SO[1094]	-8818.5	245.5
1218	SO[921]	-5877.5	105.5	1276	SO[979]	-6863.5	385.5	1334	SO[1037]	-7849.5	245.5	1392	SO[1095]	-8835.5	105.5

No.	Pad name	X	Y	No.	Pad name	X	Y	No.	Pad name	X	Y
1393	SO[1096]	-8852.5	385.5	1451	SO[1154]	-9838.5	245.5	1509	UDR	-11179	240.5
1394	SO[1097]	-8869.5	245.5	1452	SO[1155]	-9855.5	105.5	1510	CKVR	-11049	160.5
1395	SO[1098]	-8886.5	105.5	1453	SO[1156]	-9872.5	385.5	1511	CKVR	-11179	160.5
1396	SO[1099]	-8903.5	385.5	1454	SO[1157]	-9889.5	245.5	1512	STV1R	-11049	80.5
1397	SO[1100]	-8920.5	245.5	1455	SO[1158]	-9906.5	105.5	1513	STV1R	-11179	80.5
1398	SO[1101]	-8937.5	105.5	1456	SO[1159]	-9923.5	385.5	1514	STV2R	-11049	0.5
1399	SO[1102]	-8954.5	385.5	1457	SO[1160]	-9940.5	245.5	1515	STV2R	-11179	0.5
1400	SO[1103]	-8971.5	245.5	1458	SO[1161]	-9957.5	105.5	1516	STV1R	-11049	-79.5
1401	SO[1104]	-8988.5	105.5	1459	SO[1162]	-9974.5	385.5	1517	STV1R	-11179	-79.5
1402	SO[1105]	-9005.5	385.5	1460	SO[1163]	-9991.5	245.5	1518	STBNR	-11049	-159.5
1403	SO[1106]	-9022.5	245.5	1461	SO[1164]	-10008.5	105.5	1519	STBNR	-11179	-159.5
1404	SO[1107]	-9039.5	105.5	1462	SO[1165]	-10025.5	385.5	1520	DUMMY	-11049	-239.5
1405	SO[1108]	-9056.5	385.5	1463	SO[1166]	-10042.5	245.5	1521	DUMMY	-11179	-239.5
1406	SO[1109]	-9073.5	245.5	1464	SO[1167]	-10059.5	105.5				
1407	SO[1110]	-9090.5	105.5	1465	SO[1168]	-10076.5	385.5				
1408	SO[1111]	-9107.5	385.5	1466	SO[1169]	-10093.5	245.5				
1409	SO[1112]	-9124.5	245.5	1467	SO[1170]	-10110.5	105.5				
1410	SO[1113]	-9141.5	105.5	1468	SO[1171]	-10127.5	385.5				
1411	SO[1114]	-9158.5	385.5	1469	SO[1172]	-10144.5	245.5				
1412	SO[1115]	-9175.5	245.5	1470	SO[1173]	-10161.5	105.5				
1413	SO[1116]	-9192.5	105.5	1471	SO[1174]	-10178.5	385.5				
1414	SO[1117]	-9209.5	385.5	1472	SO[1175]	-10195.5	245.5				
1415	SO[1118]	-9226.5	245.5	1473	SO[1176]	-10212.5	105.5				
1416	SO[1119]	-9243.5	105.5	1474	SO[1177]	-10229.5	385.5				
1417	SO[1120]	-9260.5	385.5	1475	SO[1178]	-10246.5	245.5				
1418	SO[1121]	-9277.5	245.5	1476	SO[1179]	-10263.5	105.5				
1419	SO[1122]	-9294.5	105.5	1477	SO[1180]	-10280.5	385.5				
1420	SO[1123]	-9311.5	385.5	1478	SO[1181]	-10297.5	245.5				
1421	SO[1124]	-9328.5	245.5	1479	SO[1182]	-10314.5	105.5				
1422	SO[1125]	-9345.5	105.5	1480	SO[1183]	-10331.5	385.5				
1423	SO[1126]	-9362.5	385.5	1481	SO[1184]	-10348.5	245.5				
1424	SO[1127]	-9379.5	245.5	1482	SO[1185]	-10365.5	105.5				
1425	SO[1128]	-9396.5	105.5	1483	SO[1186]	-10382.5	385.5				
1426	SO[1129]	-9413.5	385.5	1484	SO[1187]	-10399.5	245.5				
1427	SO[1130]	-9430.5	245.5	1485	SO[1188]	-10416.5	105.5				
1428	SO[1131]	-9447.5	105.5	1486	SO[1189]	-10433.5	385.5				
1429	SO[1132]	-9464.5	385.5	1487	SO[1190]	-10450.5	245.5				
1430	SO[1133]	-9481.5	245.5	1488	SO[1191]	-10467.5	105.5				
1431	SO[1134]	-9498.5	105.5	1489	SO[1192]	-10484.5	385.5				
1432	SO[1135]	-9515.5	385.5	1490	SO[1193]	-10501.5	245.5				
1433	SO[1136]	-9532.5	245.5	1491	SO[1194]	-10518.5	105.5				
1434	SO[1137]	-9549.5	105.5	1492	SO[1195]	-10535.5	385.5				
1435	SO[1138]	-9566.5	385.5	1493	SO[1196]	-10552.5	245.5				
1436	SO[1139]	-9583.5	245.5	1494	SO[1197]	-10569.5	105.5				
1437	SO[1140]	-9600.5	105.5	1495	SO[1198]	-10586.5	385.5				
1438	SO[1141]	-9617.5	385.5	1496	SO[1199]	-10603.5	245.5				
1439	SO[1142]	-9634.5	245.5	1497	SO[1200]	-10620.5	105.5				
1440	SO[1143]	-9651.5	105.5	1498	SHIELDING	-10664	405.5				
1441	SO[1144]	-9668.5	385.5	1499	COM1_T	-10714	405.5				
1442	SO[1145]	-9685.5	245.5	1500	COM1_T	-10764	405.5				
1443	SO[1146]	-9702.5	105.5	1501	SHIELDING	-10814	405.5				
1444	SO[1147]	-9719.5	385.5	1502	TN9	-10864	405.5				
1445	SO[1148]	-9736.5	245.5	1503	TN9	-10914	405.5				
1446	SO[1149]	-9753.5	105.5	1504	INVBRR	-11049	400.5				
1447	SO[1150]	-9770.5	385.5	1505	INVBRR	-11179	400.5				
1448	SO[1151]	-9787.5	245.5	1506	OEVR	-11049	320.5				
1449	SO[1152]	-9804.5	105.5	1507	OEVR	-11179	320.5				
1450	SO[1153]	-9821.5	385.5	1508	UDR	-11049	240.5				

10. Revision History

Version No.	Date	Page	Description
0.01	2024/06/25	All	New set up