



# **EK79202B**

*Rev. 1.1*

PRELIMINARY DATA SHEET

**2052CH Source Driver with TCON**  
**LVDS Interface**

*fitipower integrated technology inc.*

## Table of Contents

|                                                                   | Page |
|-------------------------------------------------------------------|------|
| 1. General Description .....                                      | 3    |
| 2. Features .....                                                 | 3    |
| 3. Chip Function Block Diagram .....                              | 4    |
| 4. Pad Arrangement .....                                          | 5    |
| 5. Application Diagram with Panel .....                           | 6    |
| 5.1 GIP Application_1366RGBx768 (Normal Dual Gate Driving) .....  | 6    |
| 5.2 GIP Application_1280RGBx800 (Normal Dual Gate Driving) .....  | 7    |
| 5.3 GIP Application_1280RGBx800 ((Dual Gate+Zigzag Driving) ..... | 8    |
| 5.4 GIP Application_1024RGBx768 (Normal Dual Gate Driving) .....  | 9    |
| 5.5 Cascade Application1_1366RGBx768 .....                        | 10   |
| 5.6 Cascade Application2_1366RGBx768 .....                        | 11   |
| 5.7 Cascade Application3_1366RGBx768 .....                        | 12   |
| 5.8 Cascade Application4_1280RGBx800 .....                        | 13   |
| 5.9 Cascade Application5_1280RGBx800 .....                        | 14   |
| 5.10 Cascade Application6_1280RGBx800 .....                       | 15   |
| 5.11 Dual gate & GOA Application note .....                       | 16   |
| 5.12 Normal Dual gate & GOA Application note .....                | 17   |
| 6. Pin Function Description .....                                 | 18   |
| 6.1 Pin define .....                                              | 18   |
| 6.2 Value of wiring resistance to each pin .....                  | 24   |
| 6.3 GOUT Power domain for GIP Application .....                   | 25   |
| 7. Register Command Format .....                                  | 26   |
| 7.1 I2C format .....                                              | 26   |
| 7.1.1 Register Write Sequence of I2C Interface .....              | 26   |
| 7.1.2 Register Read Sequence of I2C Interface .....               | 27   |
| 7.2 SPI format .....                                              | 28   |
| 8. Video Interface .....                                          | 29   |
| 8.1 LVDS interface .....                                          | 29   |
| 9. Timing Table .....                                             | 30   |
| 9.1 Input Timing Table .....                                      | 30   |
| 9.2 Gate Output Timing Table .....                                | 34   |
| 10. Power Sequence and External Power Circuit .....               | 35   |
| 10.1 Power Generation .....                                       | 35   |
| 10.2 Power on sequence .....                                      | 36   |
| 10.3 Application power circuit .....                              | 38   |
| 11. Function Description .....                                    | 39   |
| 11.1 BIST pattern .....                                           | 39   |
| 12. Gamma Correction Resistances .....                            | 40   |
| 12.1 Relationship between input data and output voltage .....     | 41   |
| 13. DC Characteristics .....                                      | 42   |
| 13.1 Absolute maximum ratings .....                               | 42   |
| 13.2 Typical operating condition .....                            | 42   |
| 13.3 DC electrical characteristics .....                          | 43   |
| 13.4 LVDS DC electrical characteristics .....                     | 44   |
| 14. AC Characteristics .....                                      | 46   |
| 14.1 LVDS mode AC electrical characteristics .....                | 46   |
| 14.2 Source output timing (SOUT0 ~ SOUT2051) .....                | 47   |
| 14.3 Serial interface characteristics .....                       | 48   |
| 14.4 Timing requirements for RESETB .....                         | 50   |
| 15. Chip Outline Dimension .....                                  | 51   |
| 15.1 Alignment mark .....                                         | 52   |
| 15.2 Pad Coordinate .....                                         | 53   |
| 16. REVISION HISTORY .....                                        | 70   |

## Single Chip 2052 Channel Source Driver With Timing Controller for TFT LCD

### 1. General Description

The EK79202 is a highly integrated solution for small size to middle size  $\alpha$ -Si TFT-LCD panels. This chip integrates 2052 channel source driver a timing controller for color TFT LCD panel. The chip support LVDS interface. And support the function setting through R/W SPI/3-wire serial interface

### 2. Features

- Single chip solution for a WXGA a-Si type LCD display
- Integrate 2052 channel source driver and timing controller
- Display Resolution :
  - 1366 RGB x 768
  - 1280 RGB x 800
  - 1280 RGB x 720
  - 1024 RGB x 600
  - 960 RGB x 640
  - 800 RGB x 600
- System Interfaces:
  - LVDS interface (6/8 bit)
- Integrate 2052 channel source driver and timing controller
- Support for Programming Gamma correction
- OTP memory to store initialization register settings
- Support SPI/I2C interface
- Supports Zigzag /Column inversion
- Gate driver control signals for G1P
- Internal level shifter for Gate driver control
- Built-In VCOM generator
- Built-In Enhanced BIST pattern
- Built-In OTP (6Times) to store VCOM calibration
- Built-In OTP (3Times) to store gamma calibration
- COG package
- Input voltage ranges:
  - I/O and interface power supply (VDDIO): 2.3V to 3.6V
  - High speed interface power supply (VDD\_IF): 2.3V to 3.6V
  - Power for digital circuit(VDD): 2.3V~3.6V
  - OTP programming voltage (VOTP): 8.25V+/- 0.25V
  - Analog voltage range for VSP: 4.5V to 6.0V
  - Analog voltage range for VSN: -4.5V to -6.0V
  - Analog voltage range for VGH: 11V to 24V
  - Analog voltage range for VGL: -6V to -17V
  - VGH,VGL: VGH-(VGL)<32V
- Output voltage ranges:
  - Analog voltage range for VCL : VSN+2.4V
  - Positive source output voltage level: VGMP= 3.5V to 5.8V
  - Negative source output voltage level: VGMP= -3.5V to -5.8V
  - Positive gate driver output voltage level: VGH\_REG= 5.5V
  - Negative gate driver output voltage level: VGL\_REG= -4.5V to -15V
  - VCOM= -0.5V to -2.405V , step=15mV (7-bit resolution)

3. Chip Function Block Diagram

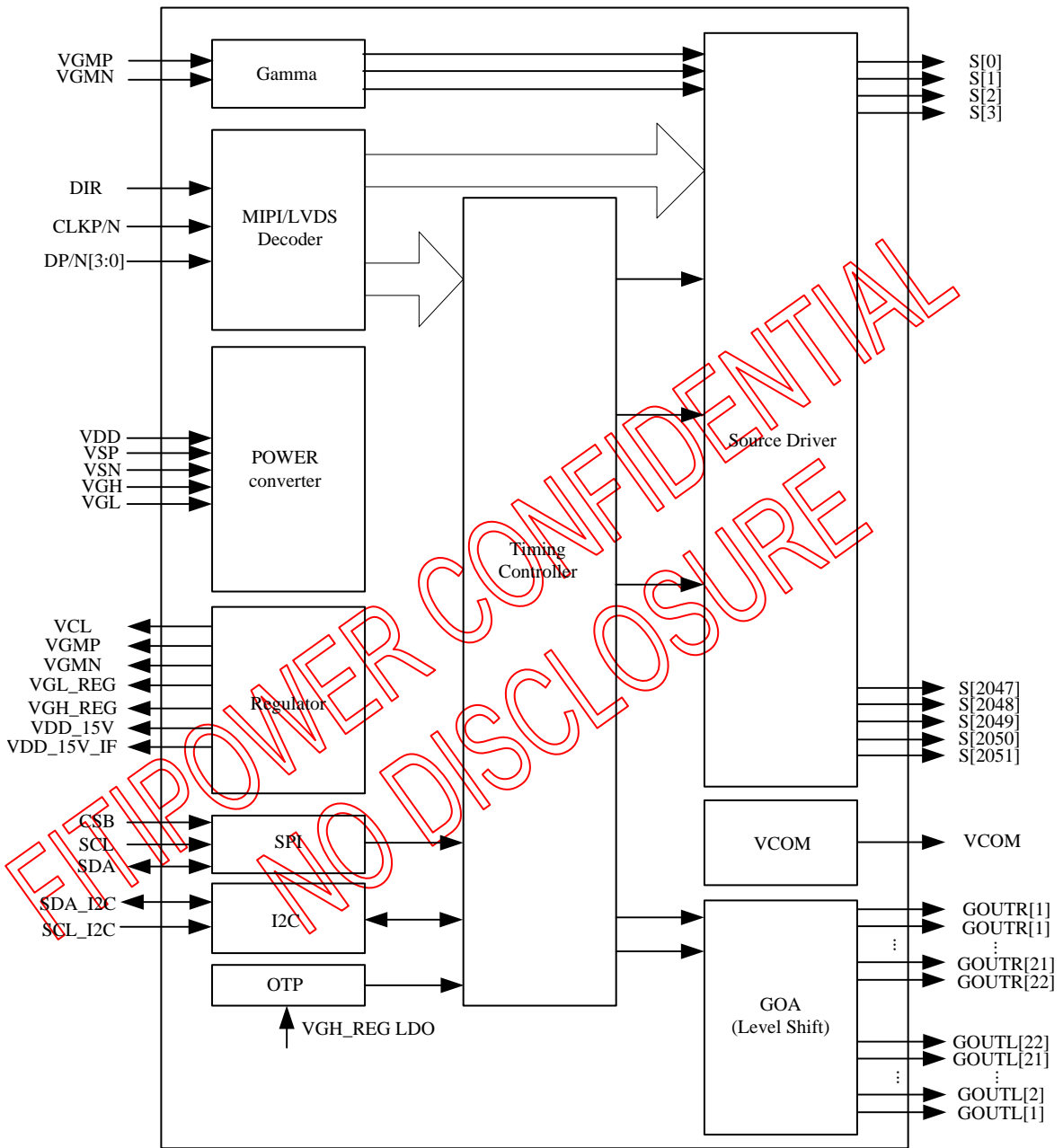

4. Pad Arrangement

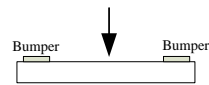
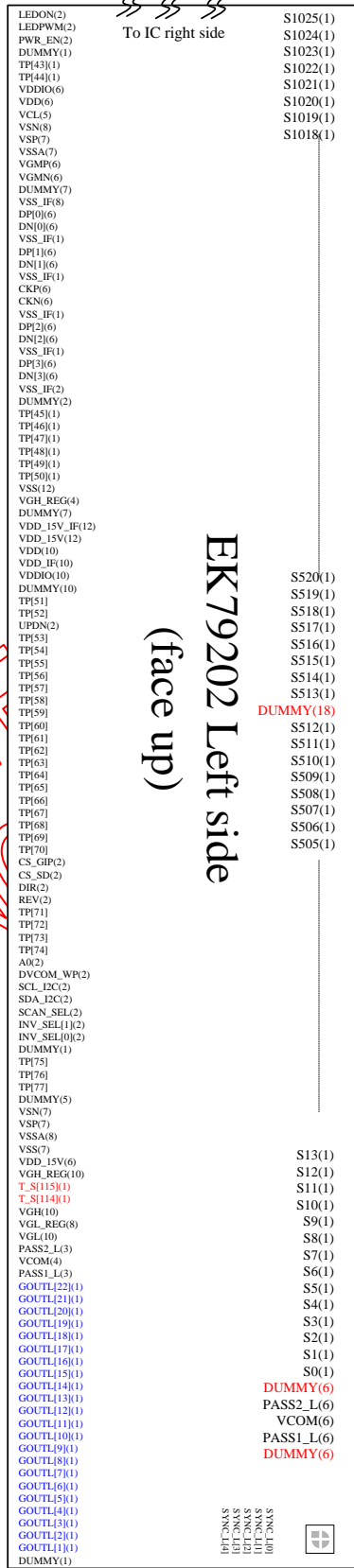
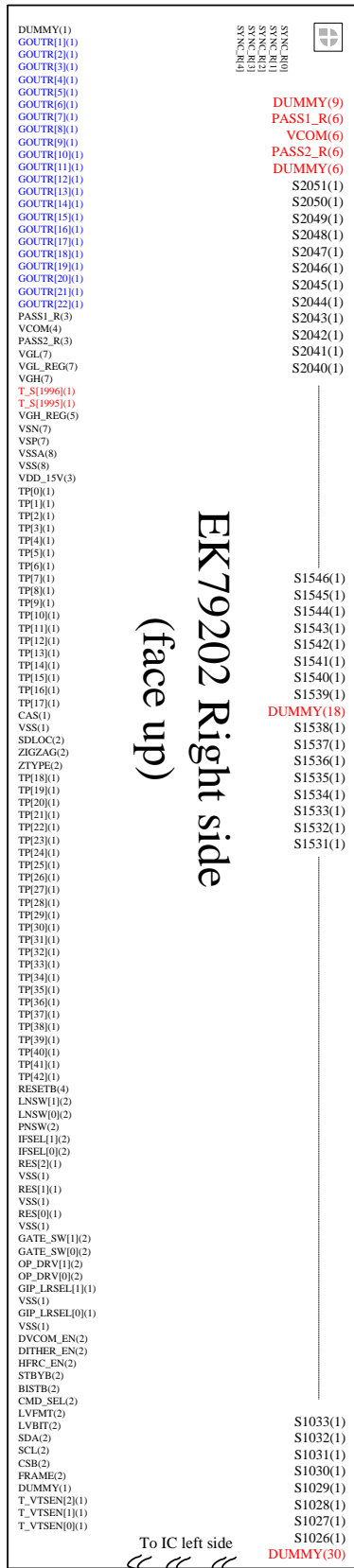

5. Application Diagram with Panel

5.1 GIP Application\_1366RGBx768 (Normal Dual Gate Driving)

Driving method : Cascade=0

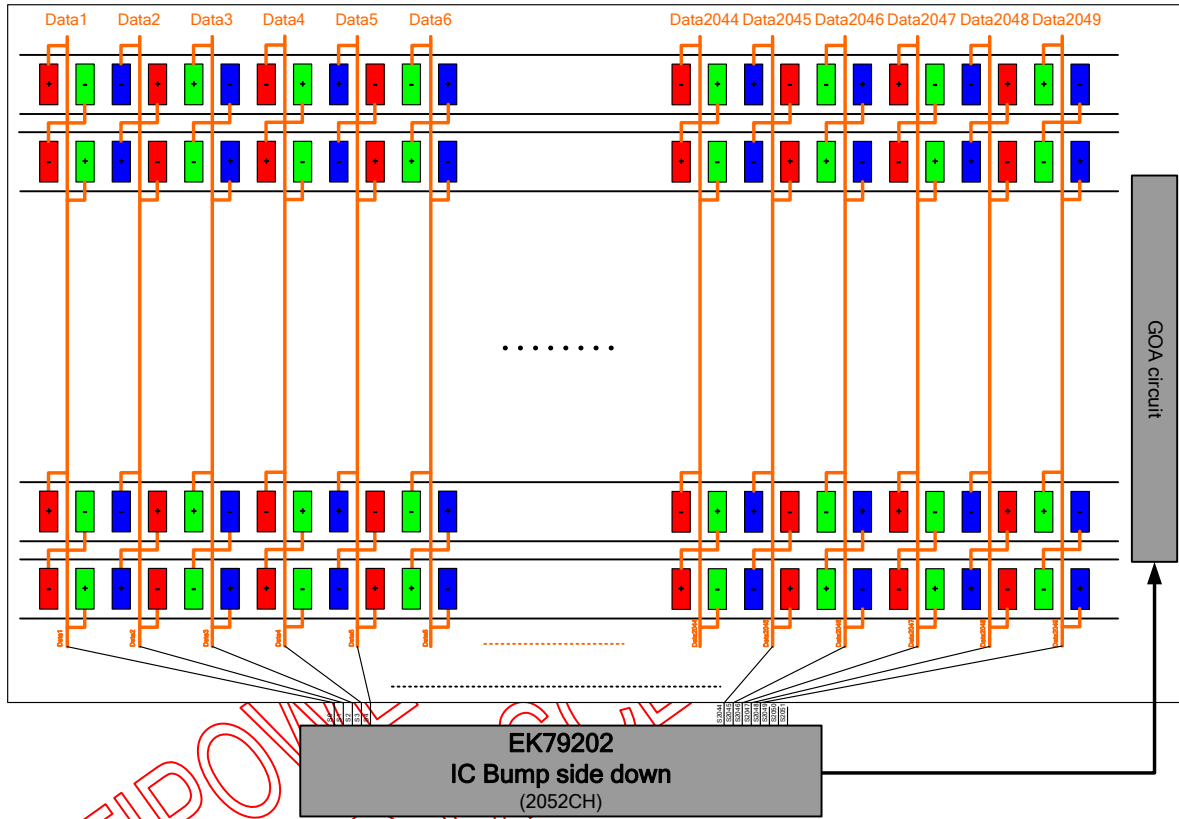

| Resolution  | Source channel | Disable channel |
|-------------|----------------|-----------------|
| 1366RGBx768 | S[2051:0]      | -               |

5.2 GIP Application\_1280RGBx800 (Normal Dual Gate Driving)

Driving method : Cascade=0

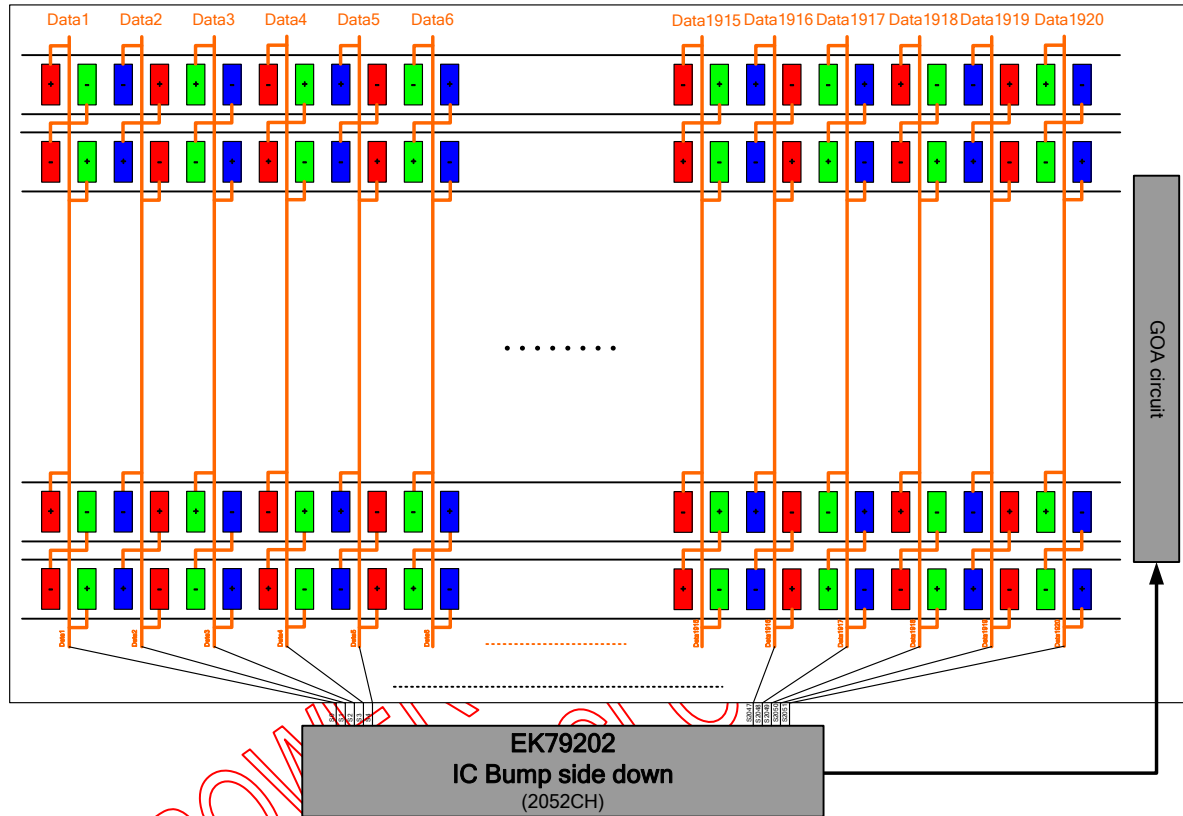

| Resolution  | Source channel            | Disable channel |
|-------------|---------------------------|-----------------|
| 1280RGBx800 | S[959:0] and S[2051:1092] | S[1091:960]     |

5.3 GIP Application\_1280RGBx800 ((Dual Gate+Zigzag Driving)

Driving method : Cascade=0

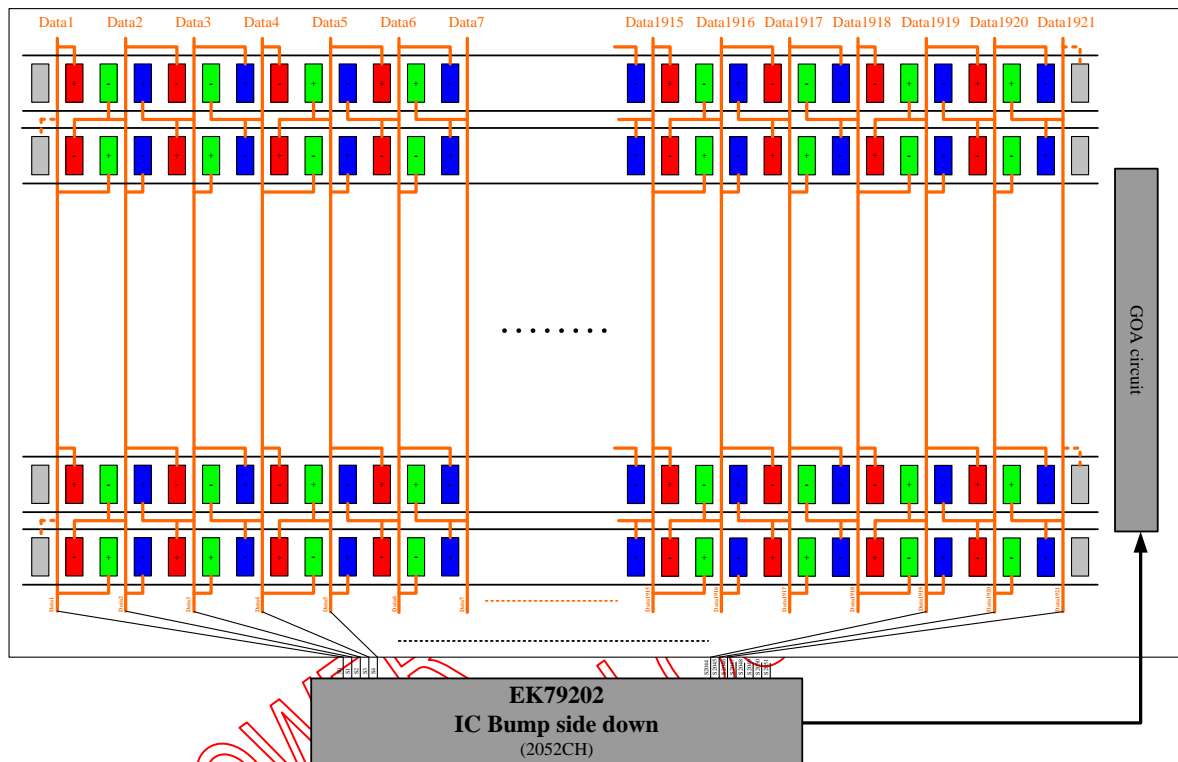

| Resolution  | Source channel            | Disable channel |
|-------------|---------------------------|-----------------|
| 1280RGBx800 | S[960:0] and S[2051:1091] | S[1090:961]     |



5.4 GIP Application\_1024RGBx768 (Normal Dual Gate Driving)

Driving method : Cascade=0

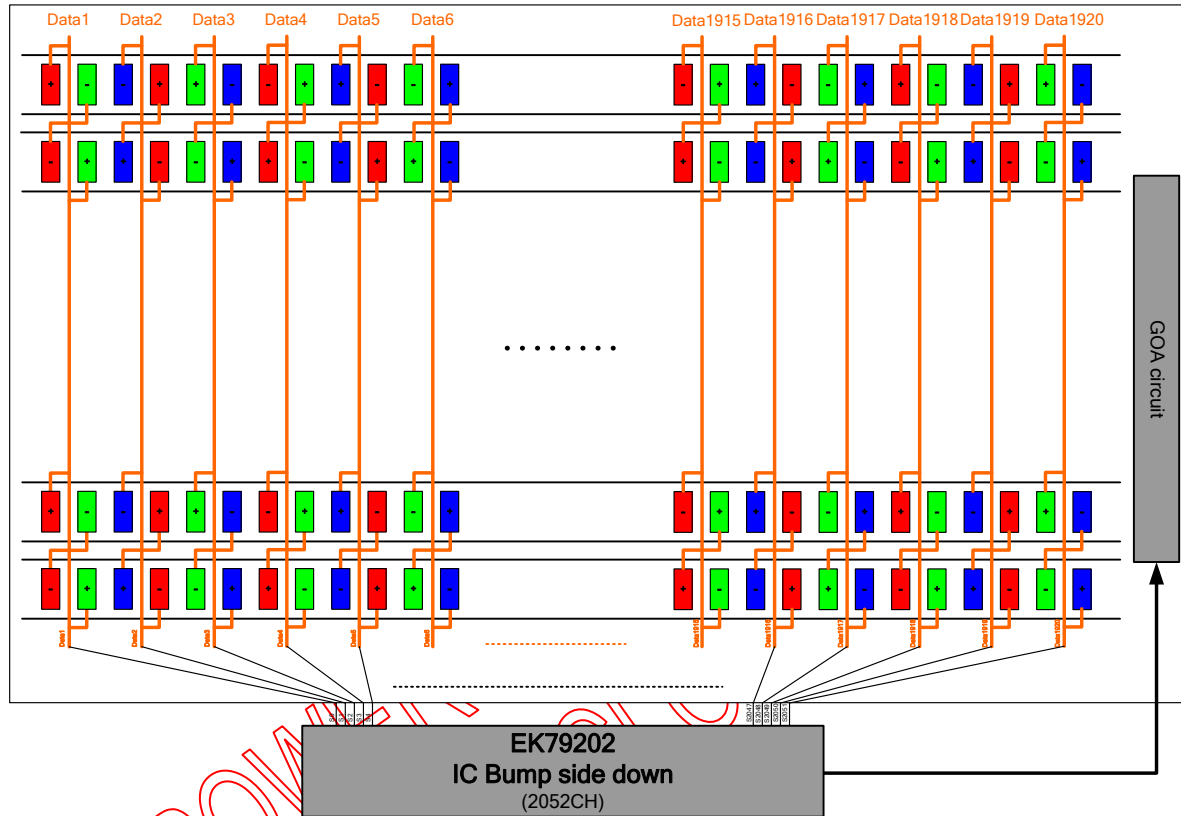

| Resolution  | Source channel            | Disable channel |
|-------------|---------------------------|-----------------|
| 1024RGBx768 | S[767:0] and S[2051:1284] | S[1283:768]     |

5.5 Cascade Application1\_1366RGBx768

Driving method : Cascade=1 / Zigzag=0

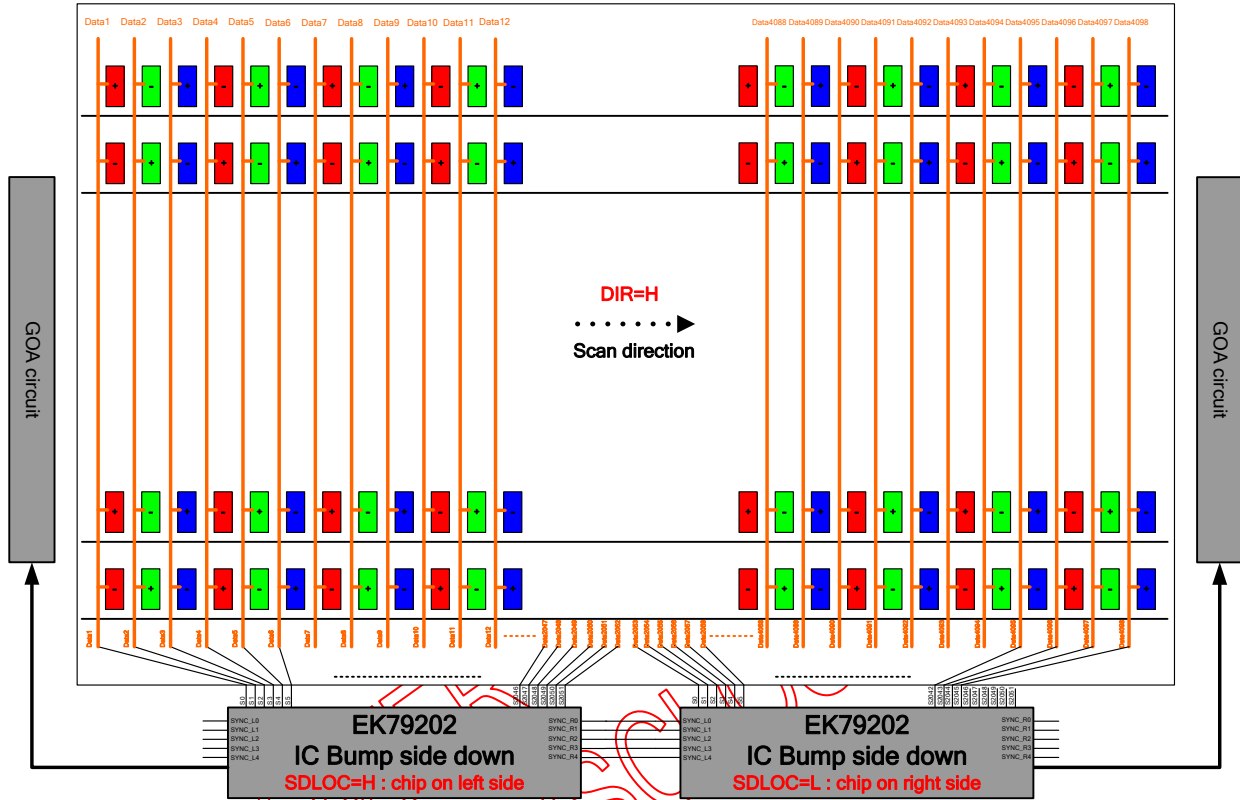

FITIPOWER NO DISC

5.6 Cascade Application2\_1366RGBx768

Driving method : Cascade=1 / Zigzag=1 / ZTYPE=0

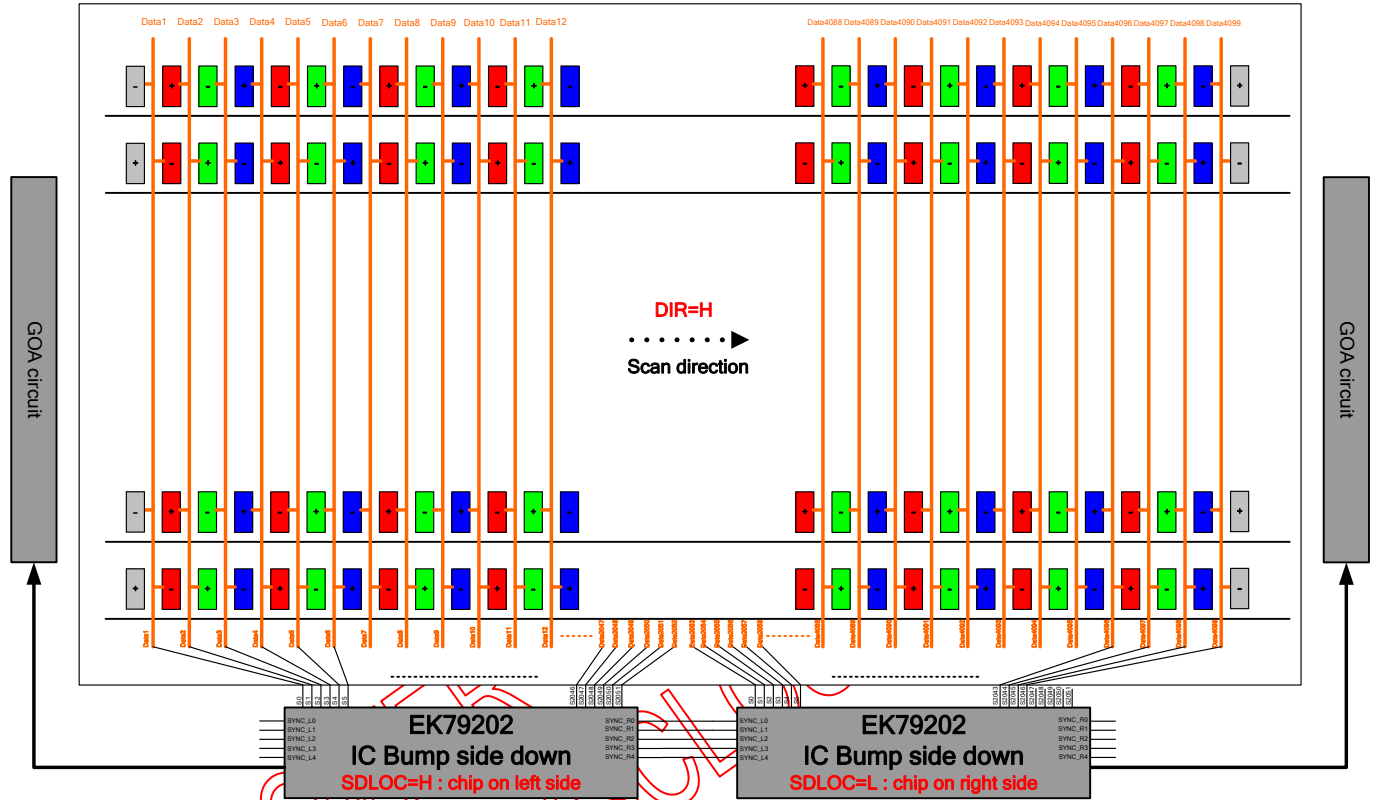

5.7 Cascade Application3\_1366RGBx768

Driving method : Cascade=1 / Zigzag=1 / ZTYPE=1

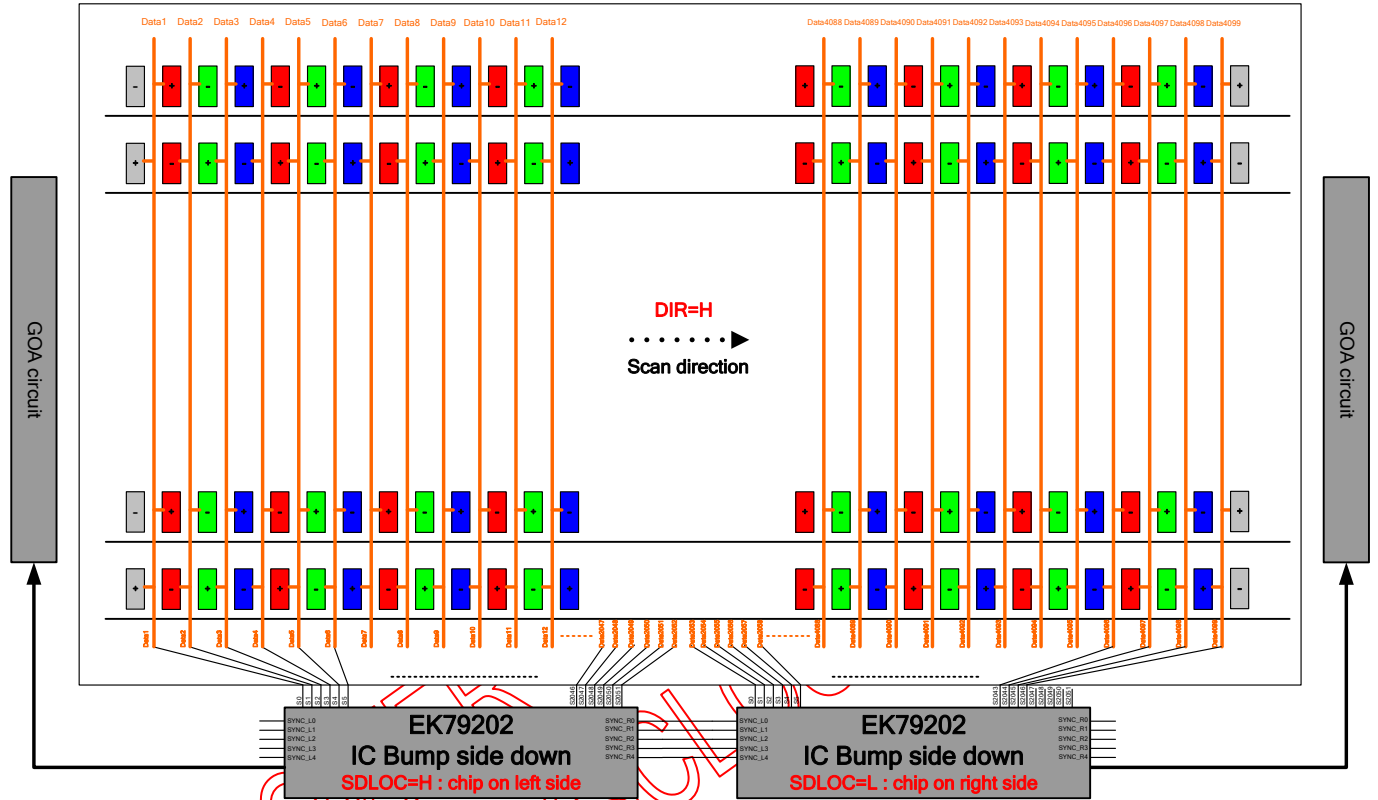

FITIPOWER NO DISCOUNT

5.8 Cascade Application4\_1280RGBx800

Driving method : Cascade=1 / Zigzag=0

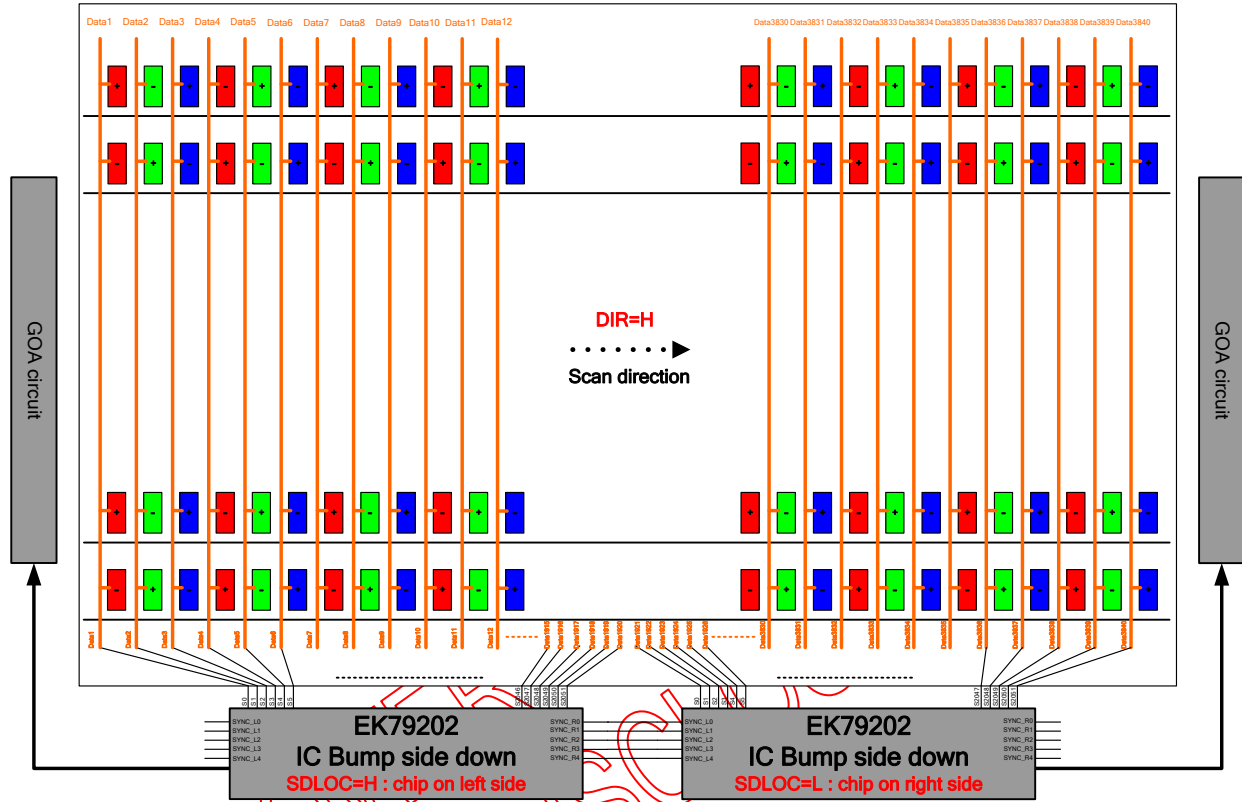

FITIPOWER NO DISC

5.9 Cascade Application5\_1280RGBx800

Driving method : Cascade=1 / Zigzag=1 / ZTYPE=0

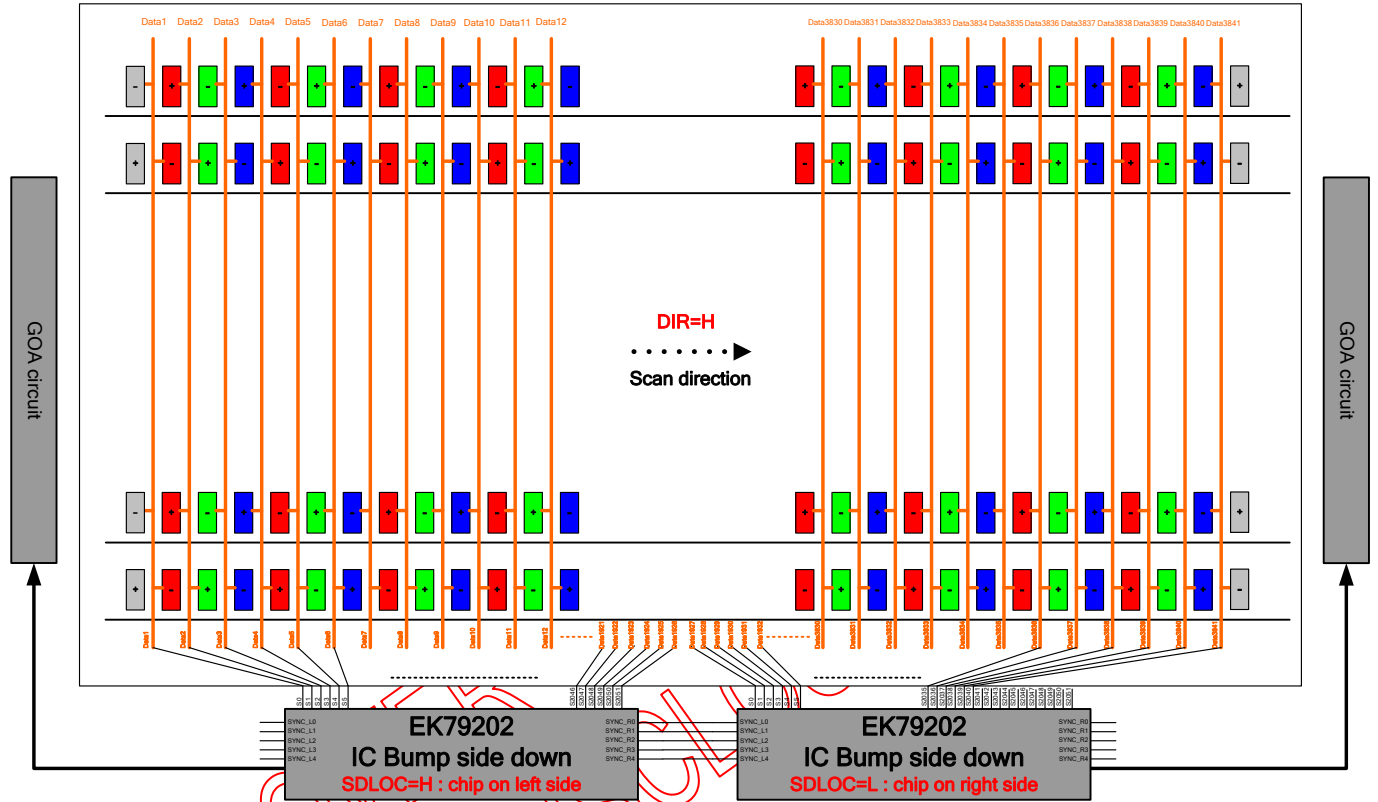

FITIPOWER NO DISSEM

5.10 Cascade Application6\_1280RGBx800

Driving method : Cascade=1 / Zigzag=1 / ZTYPE=1

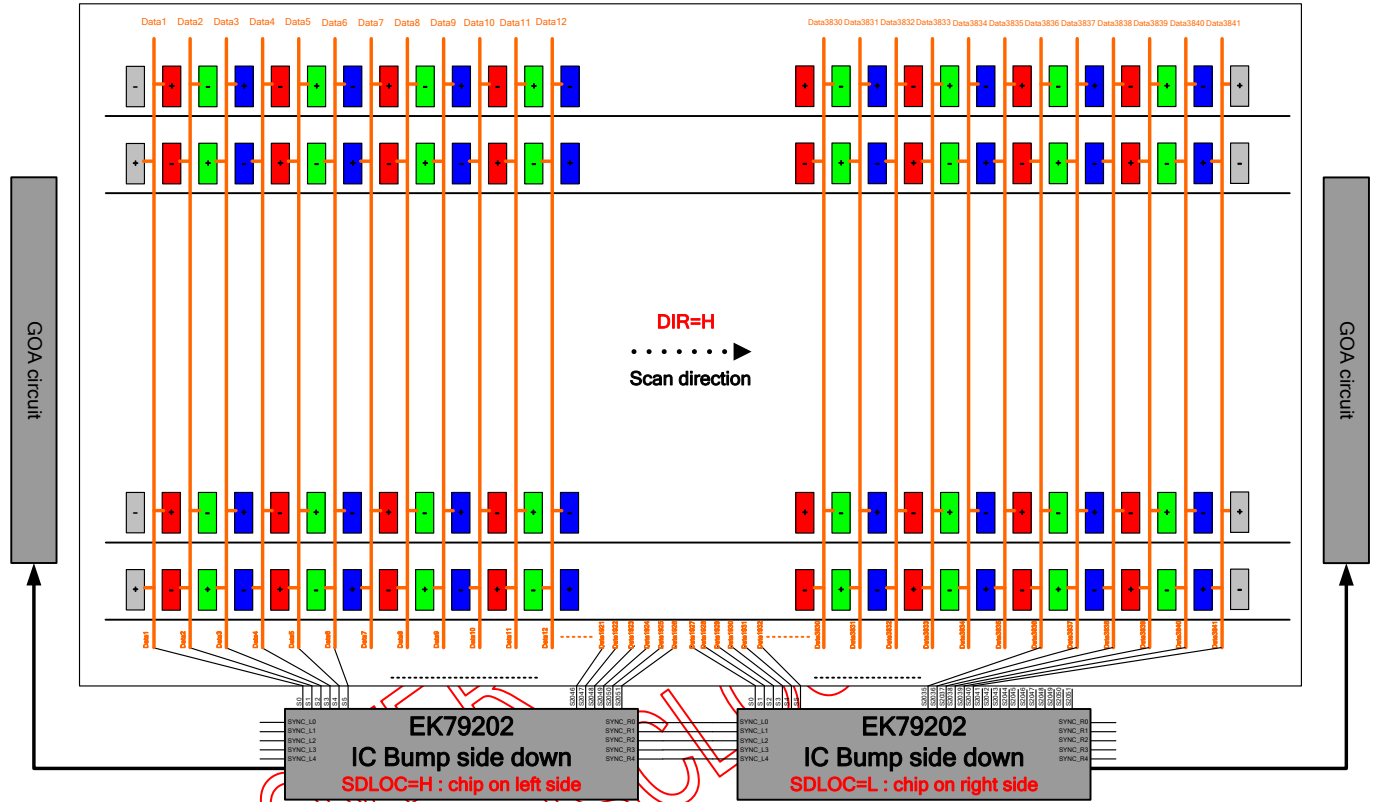

FITIPOWER NO DISSEM

5.11 Dual gate & GOA Application note

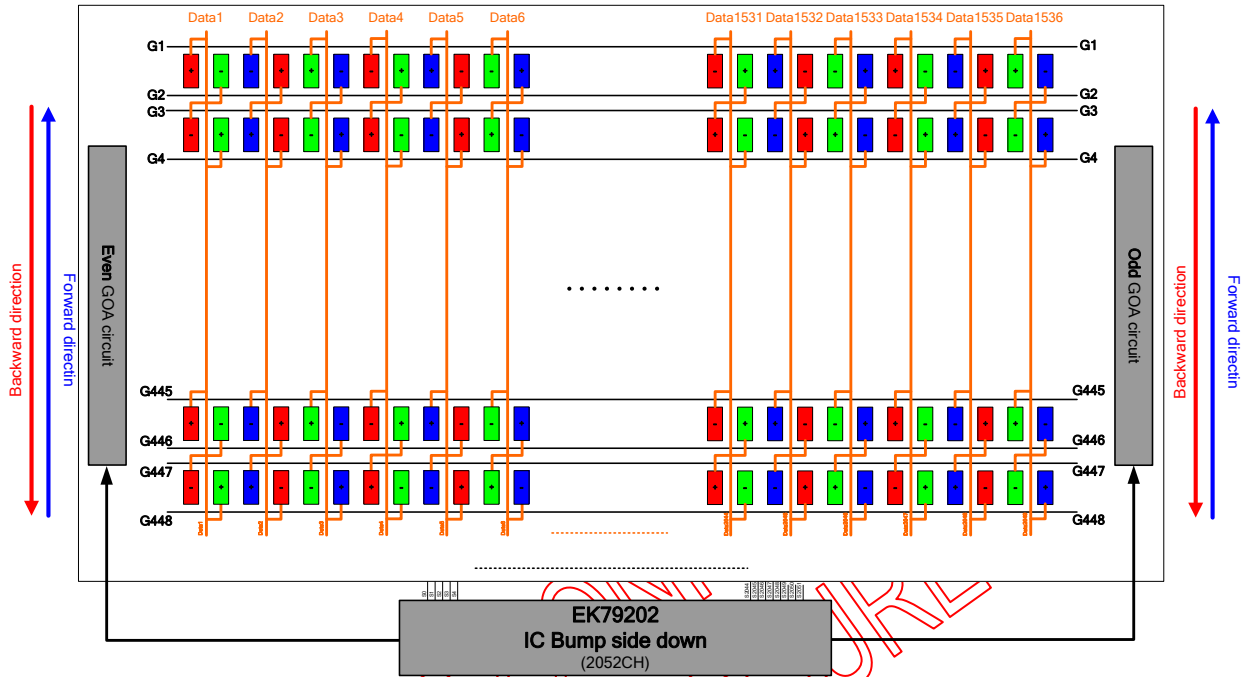

|                           |        | UPDN=L                    | UPDN=H                    |
|---------------------------|--------|---------------------------|---------------------------|
| <b>Backward direction</b> | Source | <b>Data1</b> : R>G>R>G    | <b>Data1</b> : G>R>G>R    |
|                           | GOA    | G1>G2>G3>G4 . . .         | G2>G1>G4>G3 . . .         |
| <b>Forward direction</b>  | Source | <b>Data1</b> : R>G>R>G    | <b>Data1</b> : G>R>G>R    |
|                           | GOA    | G447>G448>G445>G446 . . . | G448>G447>G446>G445 . . . |



5.12 Normal Dual gate & GOA Application note

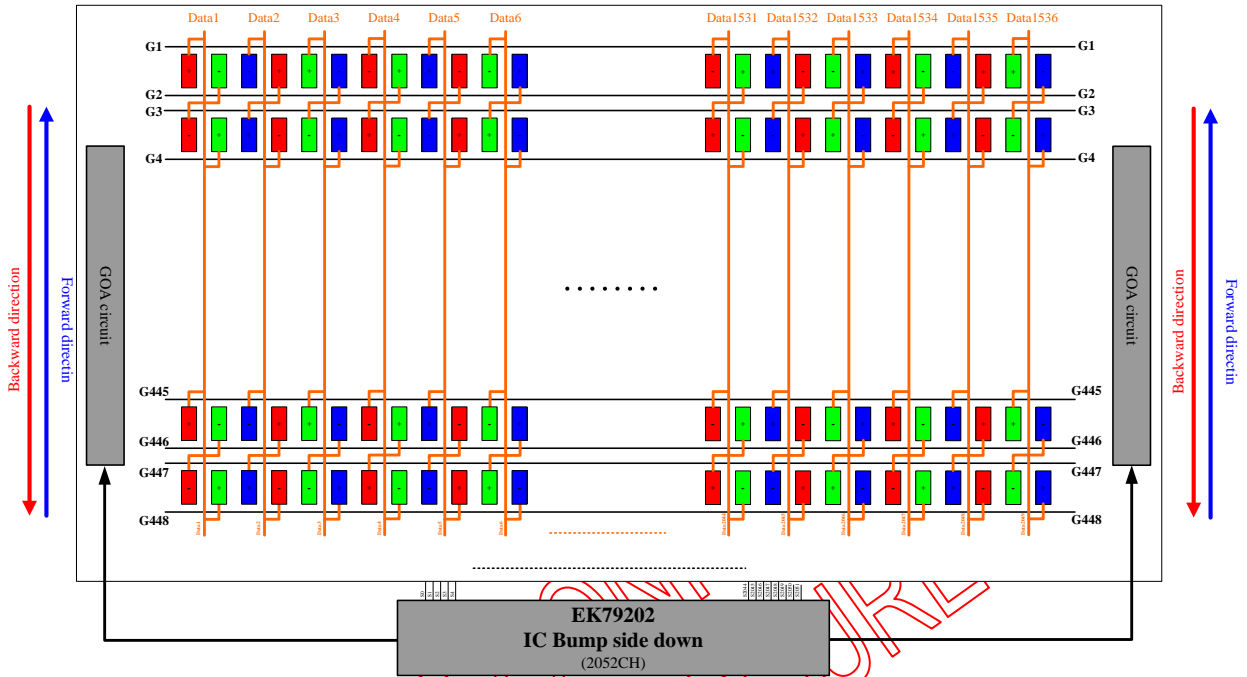

|                    |        |        |                           |
|--------------------|--------|--------|---------------------------|
| Backward direction | UPDN=L | Source | Data1 : R>G>R>G           |
|                    |        | GOA    | G1>G2>G3>G4 . . .         |
| Forward direction  | UPDN=H | Source | Data1 : G>R>G>R           |
|                    |        | GOA    | G448>G447>G446>G445 . . . |

## 6. Pin Function Description

### 6.1 Pin define

| Pin Name                                                                                                                                                                                                                                                         | Pin Type                               | Description                                                                                                                                                                                                                                                                                                                                                                                                                                                                                                                                                                                     |             |                   |             |                                        |         |                                        |         |            |          |         |         |            |       |       |          |             |       |    |       |             |        |       |       |             |    |    |     |             |    |    |    |     |    |    |    |
|------------------------------------------------------------------------------------------------------------------------------------------------------------------------------------------------------------------------------------------------------------------|----------------------------------------|-------------------------------------------------------------------------------------------------------------------------------------------------------------------------------------------------------------------------------------------------------------------------------------------------------------------------------------------------------------------------------------------------------------------------------------------------------------------------------------------------------------------------------------------------------------------------------------------------|-------------|-------------------|-------------|----------------------------------------|---------|----------------------------------------|---------|------------|----------|---------|---------|------------|-------|-------|----------|-------------|-------|----|-------|-------------|--------|-------|-------|-------------|----|----|-----|-------------|----|----|----|-----|----|----|----|
| Interface and Control                                                                                                                                                                                                                                            |                                        |                                                                                                                                                                                                                                                                                                                                                                                                                                                                                                                                                                                                 |             |                   |             |                                        |         |                                        |         |            |          |         |         |            |       |       |          |             |       |    |       |             |        |       |       |             |    |    |     |             |    |    |    |     |    |    |    |
| DP[0]/DN[0]<br>DP[1]/DN[1]<br>DP[2]/DN[2]<br>DP[3]/DN[3]                                                                                                                                                                                                         | Input                                  | data Input.<br>Select by IFSEL[1:0] pin                                                                                                                                                                                                                                                                                                                                                                                                                                                                                                                                                         |             |                   |             |                                        |         |                                        |         |            |          |         |         |            |       |       |          |             |       |    |       |             |        |       |       |             |    |    |     |             |    |    |    |     |    |    |    |
| CKP/CKN                                                                                                                                                                                                                                                          | Input                                  | LVDS clock Input.                                                                                                                                                                                                                                                                                                                                                                                                                                                                                                                                                                               |             |                   |             |                                        |         |                                        |         |            |          |         |         |            |       |       |          |             |       |    |       |             |        |       |       |             |    |    |     |             |    |    |    |     |    |    |    |
| IFSEL[1:0]<br>(VDDIO)                                                                                                                                                                                                                                            | Input                                  | LVDS Interface selection. <b>Normally pull high.</b>                                                                                                                                                                                                                                                                                                                                                                                                                                                                                                                                            |             |                   |             |                                        |         |                                        |         |            |          |         |         |            |       |       |          |             |       |    |       |             |        |       |       |             |    |    |     |             |    |    |    |     |    |    |    |
|                                                                                                                                                                                                                                                                  |                                        | <table border="1"> <thead> <tr> <th>IFSEL1</th> <th>IFSEL0</th> <th>Function</th> </tr> </thead> <tbody> <tr> <td>0</td> <td>0</td> <td>Reserved</td> </tr> <tr> <td>0</td> <td>1</td> <td>LVDS</td> </tr> <tr> <td>1</td> <td>0</td> <td>Reserved</td> </tr> <tr> <td>1</td> <td>1</td> <td>Reserved</td> </tr> </tbody> </table>                                                                                                                                                                                                                                                              | IFSEL1      | IFSEL0            | Function    | 0                                      | 0       | Reserved                               | 0       | 1          | LVDS     | 1       | 0       | Reserved   | 1     | 1     | Reserved |             |       |    |       |             |        |       |       |             |    |    |     |             |    |    |    |     |    |    |    |
|                                                                                                                                                                                                                                                                  |                                        | IFSEL1                                                                                                                                                                                                                                                                                                                                                                                                                                                                                                                                                                                          | IFSEL0      | Function          |             |                                        |         |                                        |         |            |          |         |         |            |       |       |          |             |       |    |       |             |        |       |       |             |    |    |     |             |    |    |    |     |    |    |    |
|                                                                                                                                                                                                                                                                  |                                        | 0                                                                                                                                                                                                                                                                                                                                                                                                                                                                                                                                                                                               | 0           | Reserved          |             |                                        |         |                                        |         |            |          |         |         |            |       |       |          |             |       |    |       |             |        |       |       |             |    |    |     |             |    |    |    |     |    |    |    |
|                                                                                                                                                                                                                                                                  |                                        | 0                                                                                                                                                                                                                                                                                                                                                                                                                                                                                                                                                                                               | 1           | LVDS              |             |                                        |         |                                        |         |            |          |         |         |            |       |       |          |             |       |    |       |             |        |       |       |             |    |    |     |             |    |    |    |     |    |    |    |
| 1                                                                                                                                                                                                                                                                | 0                                      | Reserved                                                                                                                                                                                                                                                                                                                                                                                                                                                                                                                                                                                        |             |                   |             |                                        |         |                                        |         |            |          |         |         |            |       |       |          |             |       |    |       |             |        |       |       |             |    |    |     |             |    |    |    |     |    |    |    |
| 1                                                                                                                                                                                                                                                                | 1                                      | Reserved                                                                                                                                                                                                                                                                                                                                                                                                                                                                                                                                                                                        |             |                   |             |                                        |         |                                        |         |            |          |         |         |            |       |       |          |             |       |    |       |             |        |       |       |             |    |    |     |             |    |    |    |     |    |    |    |
| <b>LVDS data/clk lane swapping selection pins.</b>                                                                                                                                                                                                               |                                        |                                                                                                                                                                                                                                                                                                                                                                                                                                                                                                                                                                                                 |             |                   |             |                                        |         |                                        |         |            |          |         |         |            |       |       |          |             |       |    |       |             |        |       |       |             |    |    |     |             |    |    |    |     |    |    |    |
| LNSW[1:0]<br>(VDDIO)                                                                                                                                                                                                                                             | Input                                  | <table border="1"> <thead> <tr> <th rowspan="2">LNSW[1:0]</th> <th colspan="5">LVDS Lane Mapping</th> </tr> <tr> <th>D0(PAD)</th> <th>D1(PAD)</th> <th>CLK(PAD)</th> <th>D2(PAD)</th> <th>D3(PAD)</th> </tr> </thead> <tbody> <tr> <td>00</td> <td>D0</td> <td>D1</td> <td>CLK</td> <td>D2</td> <td>D3</td> </tr> <tr> <td>01</td> <td>D0</td> <td>D1</td> <td>D2</td> <td>CLK</td> <td>D3</td> </tr> <tr> <td>10</td> <td>D3</td> <td>D2</td> <td>CLK</td> <td>D1</td> <td>D0</td> </tr> <tr> <td>11</td> <td>D3</td> <td>CLK</td> <td>D2</td> <td>D1</td> <td>D0</td> </tr> </tbody> </table> | LNSW[1:0]   | LVDS Lane Mapping |             |                                        |         |                                        | D0(PAD) | D1(PAD)    | CLK(PAD) | D2(PAD) | D3(PAD) | 00         | D0    | D1    | CLK      | D2          | D3    | 01 | D0    | D1          | D2     | CLK   | D3    | 10          | D3 | D2 | CLK | D1          | D0 | 11 | D3 | CLK | D2 | D1 | D0 |
|                                                                                                                                                                                                                                                                  |                                        | LNSW[1:0]                                                                                                                                                                                                                                                                                                                                                                                                                                                                                                                                                                                       |             | LVDS Lane Mapping |             |                                        |         |                                        |         |            |          |         |         |            |       |       |          |             |       |    |       |             |        |       |       |             |    |    |     |             |    |    |    |     |    |    |    |
|                                                                                                                                                                                                                                                                  |                                        |                                                                                                                                                                                                                                                                                                                                                                                                                                                                                                                                                                                                 | D0(PAD)     | D1(PAD)           | CLK(PAD)    | D2(PAD)                                | D3(PAD) |                                        |         |            |          |         |         |            |       |       |          |             |       |    |       |             |        |       |       |             |    |    |     |             |    |    |    |     |    |    |    |
|                                                                                                                                                                                                                                                                  |                                        | 00                                                                                                                                                                                                                                                                                                                                                                                                                                                                                                                                                                                              | D0          | D1                | CLK         | D2                                     | D3      |                                        |         |            |          |         |         |            |       |       |          |             |       |    |       |             |        |       |       |             |    |    |     |             |    |    |    |     |    |    |    |
|                                                                                                                                                                                                                                                                  |                                        | 01                                                                                                                                                                                                                                                                                                                                                                                                                                                                                                                                                                                              | D0          | D1                | D2          | CLK                                    | D3      |                                        |         |            |          |         |         |            |       |       |          |             |       |    |       |             |        |       |       |             |    |    |     |             |    |    |    |     |    |    |    |
| 10                                                                                                                                                                                                                                                               | D3                                     | D2                                                                                                                                                                                                                                                                                                                                                                                                                                                                                                                                                                                              | CLK         | D1                | D0          |                                        |         |                                        |         |            |          |         |         |            |       |       |          |             |       |    |       |             |        |       |       |             |    |    |     |             |    |    |    |     |    |    |    |
| 11                                                                                                                                                                                                                                                               | D3                                     | CLK                                                                                                                                                                                                                                                                                                                                                                                                                                                                                                                                                                                             | D2          | D1                | D0          |                                        |         |                                        |         |            |          |         |         |            |       |       |          |             |       |    |       |             |        |       |       |             |    |    |     |             |    |    |    |     |    |    |    |
| <p>Note: (1) LVDS data lane sequence are used when IFSEL[1:0]=[0:1]<br/>(2) Refer to Note2</p>                                                                                                                                                                   |                                        |                                                                                                                                                                                                                                                                                                                                                                                                                                                                                                                                                                                                 |             |                   |             |                                        |         |                                        |         |            |          |         |         |            |       |       |          |             |       |    |       |             |        |       |       |             |    |    |     |             |    |    |    |     |    |    |    |
| PNSW<br>(VDDIO)                                                                                                                                                                                                                                                  | Input                                  | LVDS polarity selection pins. <b>Normally pull low.</b>                                                                                                                                                                                                                                                                                                                                                                                                                                                                                                                                         |             |                   |             |                                        |         |                                        |         |            |          |         |         |            |       |       |          |             |       |    |       |             |        |       |       |             |    |    |     |             |    |    |    |     |    |    |    |
|                                                                                                                                                                                                                                                                  |                                        | <table border="1"> <thead> <tr> <th rowspan="2">PNSW</th> <th colspan="5">Lane Mapping</th> </tr> <tr> <th>D0P/N</th> <th>D1P/N</th> <th>CLKP/N</th> <th>D2P/N</th> <th>D3P/N</th> </tr> </thead> <tbody> <tr> <td>0</td> <td>D0P/N</td> <td>D1P/N</td> <td>CLKP/N</td> <td>D2P/N</td> <td>D3P/N</td> </tr> <tr> <td>1</td> <td>D0N/P</td> <td>D1N/P</td> <td>CLKN/P</td> <td>D2N/P</td> <td>D3N/P</td> </tr> </tbody> </table>                                                                                                                                                                 | PNSW        | Lane Mapping      |             |                                        |         |                                        | D0P/N   | D1P/N      | CLKP/N   | D2P/N   | D3P/N   | 0          | D0P/N | D1P/N | CLKP/N   | D2P/N       | D3P/N | 1  | D0N/P | D1N/P       | CLKN/P | D2N/P | D3N/P |             |    |    |     |             |    |    |    |     |    |    |    |
|                                                                                                                                                                                                                                                                  |                                        | PNSW                                                                                                                                                                                                                                                                                                                                                                                                                                                                                                                                                                                            |             | Lane Mapping      |             |                                        |         |                                        |         |            |          |         |         |            |       |       |          |             |       |    |       |             |        |       |       |             |    |    |     |             |    |    |    |     |    |    |    |
| D0P/N                                                                                                                                                                                                                                                            | D1P/N                                  |                                                                                                                                                                                                                                                                                                                                                                                                                                                                                                                                                                                                 | CLKP/N      | D2P/N             | D3P/N       |                                        |         |                                        |         |            |          |         |         |            |       |       |          |             |       |    |       |             |        |       |       |             |    |    |     |             |    |    |    |     |    |    |    |
| 0                                                                                                                                                                                                                                                                | D0P/N                                  | D1P/N                                                                                                                                                                                                                                                                                                                                                                                                                                                                                                                                                                                           | CLKP/N      | D2P/N             | D3P/N       |                                        |         |                                        |         |            |          |         |         |            |       |       |          |             |       |    |       |             |        |       |       |             |    |    |     |             |    |    |    |     |    |    |    |
| 1                                                                                                                                                                                                                                                                | D0N/P                                  | D1N/P                                                                                                                                                                                                                                                                                                                                                                                                                                                                                                                                                                                           | CLKN/P      | D2N/P             | D3N/P       |                                        |         |                                        |         |            |          |         |         |            |       |       |          |             |       |    |       |             |        |       |       |             |    |    |     |             |    |    |    |     |    |    |    |
| <b>Panel resolution setting selection: Normally pull high</b>                                                                                                                                                                                                    |                                        |                                                                                                                                                                                                                                                                                                                                                                                                                                                                                                                                                                                                 |             |                   |             |                                        |         |                                        |         |            |          |         |         |            |       |       |          |             |       |    |       |             |        |       |       |             |    |    |     |             |    |    |    |     |    |    |    |
| RES[2:0]<br>(VDDIO)                                                                                                                                                                                                                                              | Input                                  | <table border="1"> <thead> <tr> <th>RES[2]</th> <th>RES[1]</th> <th>RES[0]</th> <th>Description</th> </tr> </thead> <tbody> <tr> <td>0</td> <td>1</td> <td>0</td> <td>800RGBx600</td> </tr> <tr> <td>0</td> <td>1</td> <td>1</td> <td>960RGBx640</td> </tr> <tr> <td>1</td> <td>0</td> <td>0</td> <td>1024RGBx600</td> </tr> <tr> <td>1</td> <td>0</td> <td>1</td> <td>1280RGBx800</td> </tr> <tr> <td>1</td> <td>1</td> <td>0</td> <td>1280RGBx800</td> </tr> <tr> <td>1</td> <td>1</td> <td>1</td> <td>1366RGBx768</td> </tr> </tbody> </table>                                               | RES[2]      | RES[1]            | RES[0]      | Description                            | 0       | 1                                      | 0       | 800RGBx600 | 0        | 1       | 1       | 960RGBx640 | 1     | 0     | 0        | 1024RGBx600 | 1     | 0  | 1     | 1280RGBx800 | 1      | 1     | 0     | 1280RGBx800 | 1  | 1  | 1   | 1366RGBx768 |    |    |    |     |    |    |    |
|                                                                                                                                                                                                                                                                  |                                        | RES[2]                                                                                                                                                                                                                                                                                                                                                                                                                                                                                                                                                                                          | RES[1]      | RES[0]            | Description |                                        |         |                                        |         |            |          |         |         |            |       |       |          |             |       |    |       |             |        |       |       |             |    |    |     |             |    |    |    |     |    |    |    |
|                                                                                                                                                                                                                                                                  |                                        | 0                                                                                                                                                                                                                                                                                                                                                                                                                                                                                                                                                                                               | 1           | 0                 | 800RGBx600  |                                        |         |                                        |         |            |          |         |         |            |       |       |          |             |       |    |       |             |        |       |       |             |    |    |     |             |    |    |    |     |    |    |    |
|                                                                                                                                                                                                                                                                  |                                        | 0                                                                                                                                                                                                                                                                                                                                                                                                                                                                                                                                                                                               | 1           | 1                 | 960RGBx640  |                                        |         |                                        |         |            |          |         |         |            |       |       |          |             |       |    |       |             |        |       |       |             |    |    |     |             |    |    |    |     |    |    |    |
|                                                                                                                                                                                                                                                                  |                                        | 1                                                                                                                                                                                                                                                                                                                                                                                                                                                                                                                                                                                               | 0           | 0                 | 1024RGBx600 |                                        |         |                                        |         |            |          |         |         |            |       |       |          |             |       |    |       |             |        |       |       |             |    |    |     |             |    |    |    |     |    |    |    |
|                                                                                                                                                                                                                                                                  |                                        | 1                                                                                                                                                                                                                                                                                                                                                                                                                                                                                                                                                                                               | 0           | 1                 | 1280RGBx800 |                                        |         |                                        |         |            |          |         |         |            |       |       |          |             |       |    |       |             |        |       |       |             |    |    |     |             |    |    |    |     |    |    |    |
|                                                                                                                                                                                                                                                                  |                                        | 1                                                                                                                                                                                                                                                                                                                                                                                                                                                                                                                                                                                               | 1           | 0                 | 1280RGBx800 |                                        |         |                                        |         |            |          |         |         |            |       |       |          |             |       |    |       |             |        |       |       |             |    |    |     |             |    |    |    |     |    |    |    |
| 1                                                                                                                                                                                                                                                                | 1                                      | 1                                                                                                                                                                                                                                                                                                                                                                                                                                                                                                                                                                                               | 1366RGBx768 |                   |             |                                        |         |                                        |         |            |          |         |         |            |       |       |          |             |       |    |       |             |        |       |       |             |    |    |     |             |    |    |    |     |    |    |    |
| <p><b>Note:</b><br/>LVDS mode : RES[2:0] setting only for resolution function,<br/>Zigzag panel structure setting depend on ZIGZAG &amp;<br/>ZTYPE pin selection(<b>Select by pin or OTP</b>)<br/><a href="#">Vertical display line set by internal OTP.</a></p> |                                        |                                                                                                                                                                                                                                                                                                                                                                                                                                                                                                                                                                                                 |             |                   |             |                                        |         |                                        |         |            |          |         |         |            |       |       |          |             |       |    |       |             |        |       |       |             |    |    |     |             |    |    |    |     |    |    |    |
| DIR<br>(VDDIO)                                                                                                                                                                                                                                                   | Input                                  | The shift direction of device internal shift register is controlled by this as shown below : <b>Normally pull high</b>                                                                                                                                                                                                                                                                                                                                                                                                                                                                          |             |                   |             |                                        |         |                                        |         |            |          |         |         |            |       |       |          |             |       |    |       |             |        |       |       |             |    |    |     |             |    |    |    |     |    |    |    |
|                                                                                                                                                                                                                                                                  |                                        | <table border="1"> <thead> <tr> <th>DIR</th> <th>Function</th> </tr> </thead> <tbody> <tr> <td>H</td> <td>OUT[0,1,2]→ . . . →OUT[2049,2050,2051]</td> </tr> <tr> <td>L</td> <td>OUT[2049,2050,2051]→ . . . →OUT[0,1,2]</td> </tr> </tbody> </table>                                                                                                                                                                                                                                                                                                                                             | DIR         | Function          | H           | OUT[0,1,2]→ . . . →OUT[2049,2050,2051] | L       | OUT[2049,2050,2051]→ . . . →OUT[0,1,2] |         |            |          |         |         |            |       |       |          |             |       |    |       |             |        |       |       |             |    |    |     |             |    |    |    |     |    |    |    |
|                                                                                                                                                                                                                                                                  |                                        | DIR                                                                                                                                                                                                                                                                                                                                                                                                                                                                                                                                                                                             | Function    |                   |             |                                        |         |                                        |         |            |          |         |         |            |       |       |          |             |       |    |       |             |        |       |       |             |    |    |     |             |    |    |    |     |    |    |    |
| H                                                                                                                                                                                                                                                                | OUT[0,1,2]→ . . . →OUT[2049,2050,2051] |                                                                                                                                                                                                                                                                                                                                                                                                                                                                                                                                                                                                 |             |                   |             |                                        |         |                                        |         |            |          |         |         |            |       |       |          |             |       |    |       |             |        |       |       |             |    |    |     |             |    |    |    |     |    |    |    |
| L                                                                                                                                                                                                                                                                | OUT[2049,2050,2051]→ . . . →OUT[0,1,2] |                                                                                                                                                                                                                                                                                                                                                                                                                                                                                                                                                                                                 |             |                   |             |                                        |         |                                        |         |            |          |         |         |            |       |       |          |             |       |    |       |             |        |       |       |             |    |    |     |             |    |    |    |     |    |    |    |
| <p><a href="#">Cascade=H + RES[2:0]=1366x768 only support DIR=H</a></p>                                                                                                                                                                                          |                                        |                                                                                                                                                                                                                                                                                                                                                                                                                                                                                                                                                                                                 |             |                   |             |                                        |         |                                        |         |            |          |         |         |            |       |       |          |             |       |    |       |             |        |       |       |             |    |    |     |             |    |    |    |     |    |    |    |

| Pin Name                  | Pin Type                                       | Description                                                                                                                                                                                                                                                                                                                                                                                                                                                                                                                                                                                                                                                                                                                                                                                                                                                                  |                           |                           |          |                                     |   |                                                |   |                      |                                                |                           |                           |                                                |                           |    |                                               |        |        |        |    |        |        |      |        |    |         |        |           |        |    |        |        |   |        |
|---------------------------|------------------------------------------------|------------------------------------------------------------------------------------------------------------------------------------------------------------------------------------------------------------------------------------------------------------------------------------------------------------------------------------------------------------------------------------------------------------------------------------------------------------------------------------------------------------------------------------------------------------------------------------------------------------------------------------------------------------------------------------------------------------------------------------------------------------------------------------------------------------------------------------------------------------------------------|---------------------------|---------------------------|----------|-------------------------------------|---|------------------------------------------------|---|----------------------|------------------------------------------------|---------------------------|---------------------------|------------------------------------------------|---------------------------|----|-----------------------------------------------|--------|--------|--------|----|--------|--------|------|--------|----|---------|--------|-----------|--------|----|--------|--------|---|--------|
| REV<br>(VDDIO)            | Input                                          | Controls whether the data of D0~D2 are inverted or not, <b>Normally pull low</b> .<br>When "REV"=1 these data will be inverted. EX. "00"→"3F", "07"→"38",<br>"15"→"2A", and so on.                                                                                                                                                                                                                                                                                                                                                                                                                                                                                                                                                                                                                                                                                           |                           |                           |          |                                     |   |                                                |   |                      |                                                |                           |                           |                                                |                           |    |                                               |        |        |        |    |        |        |      |        |    |         |        |           |        |    |        |        |   |        |
| OP_DRV[1:0]<br>(VDDIO)    | Input                                          | Source OP driving selection:<br><table border="1"> <thead> <tr> <th>OP_DRV[1]</th> <th>OP_DRV[0]</th> <th>Function</th> </tr> </thead> <tbody> <tr> <td>0</td> <td>0</td> <td>75%</td> </tr> <tr> <td>0</td> <td>1</td> <td>100%</td> </tr> <tr> <td>1</td> <td>0</td> <td>125%</td> </tr> <tr> <td>1</td> <td>1</td> <td>133%</td> </tr> </tbody> </table>                                                                                                                                                                                                                                                                                                                                                                                                                                                                                                                  | OP_DRV[1]                 | OP_DRV[0]                 | Function | 0                                   | 0 | 75%                                            | 0 | 1                    | 100%                                           | 1                         | 0                         | 125%                                           | 1                         | 1  | 133%                                          |        |        |        |    |        |        |      |        |    |         |        |           |        |    |        |        |   |        |
| OP_DRV[1]                 | OP_DRV[0]                                      | Function                                                                                                                                                                                                                                                                                                                                                                                                                                                                                                                                                                                                                                                                                                                                                                                                                                                                     |                           |                           |          |                                     |   |                                                |   |                      |                                                |                           |                           |                                                |                           |    |                                               |        |        |        |    |        |        |      |        |    |         |        |           |        |    |        |        |   |        |
| 0                         | 0                                              | 75%                                                                                                                                                                                                                                                                                                                                                                                                                                                                                                                                                                                                                                                                                                                                                                                                                                                                          |                           |                           |          |                                     |   |                                                |   |                      |                                                |                           |                           |                                                |                           |    |                                               |        |        |        |    |        |        |      |        |    |         |        |           |        |    |        |        |   |        |
| 0                         | 1                                              | 100%                                                                                                                                                                                                                                                                                                                                                                                                                                                                                                                                                                                                                                                                                                                                                                                                                                                                         |                           |                           |          |                                     |   |                                                |   |                      |                                                |                           |                           |                                                |                           |    |                                               |        |        |        |    |        |        |      |        |    |         |        |           |        |    |        |        |   |        |
| 1                         | 0                                              | 125%                                                                                                                                                                                                                                                                                                                                                                                                                                                                                                                                                                                                                                                                                                                                                                                                                                                                         |                           |                           |          |                                     |   |                                                |   |                      |                                                |                           |                           |                                                |                           |    |                                               |        |        |        |    |        |        |      |        |    |         |        |           |        |    |        |        |   |        |
| 1                         | 1                                              | 133%                                                                                                                                                                                                                                                                                                                                                                                                                                                                                                                                                                                                                                                                                                                                                                                                                                                                         |                           |                           |          |                                     |   |                                                |   |                      |                                                |                           |                           |                                                |                           |    |                                               |        |        |        |    |        |        |      |        |    |         |        |           |        |    |        |        |   |        |
| DVCOM_WP<br>(VDDIO)       | Input                                          | Write protection for internal OTP. <b>Normally High-Z</b><br><table border="1"> <thead> <tr> <th>DVCOM_WP</th> <th>Function</th> </tr> </thead> <tbody> <tr> <td>H</td> <td>Enable write protect (default)</td> </tr> <tr> <td>L</td> <td>Disable write protect</td> </tr> </tbody> </table>                                                                                                                                                                                                                                                                                                                                                                                                                                                                                                                                                                                 | DVCOM_WP                  | Function                  | H        | Enable write protect (default)      | L | Disable write protect                          |   |                      |                                                |                           |                           |                                                |                           |    |                                               |        |        |        |    |        |        |      |        |    |         |        |           |        |    |        |        |   |        |
| DVCOM_WP                  | Function                                       |                                                                                                                                                                                                                                                                                                                                                                                                                                                                                                                                                                                                                                                                                                                                                                                                                                                                              |                           |                           |          |                                     |   |                                                |   |                      |                                                |                           |                           |                                                |                           |    |                                               |        |        |        |    |        |        |      |        |    |         |        |           |        |    |        |        |   |        |
| H                         | Enable write protect (default)                 |                                                                                                                                                                                                                                                                                                                                                                                                                                                                                                                                                                                                                                                                                                                                                                                                                                                                              |                           |                           |          |                                     |   |                                                |   |                      |                                                |                           |                           |                                                |                           |    |                                               |        |        |        |    |        |        |      |        |    |         |        |           |        |    |        |        |   |        |
| L                         | Disable write protect                          |                                                                                                                                                                                                                                                                                                                                                                                                                                                                                                                                                                                                                                                                                                                                                                                                                                                                              |                           |                           |          |                                     |   |                                                |   |                      |                                                |                           |                           |                                                |                           |    |                                               |        |        |        |    |        |        |      |        |    |         |        |           |        |    |        |        |   |        |
| DVCOM_EN<br>(VDDIO)       | Input                                          | DVCOM selection: <b>Normally pull low</b><br><table border="1"> <thead> <tr> <th>DVCOM_EN</th> <th>Function</th> </tr> </thead> <tbody> <tr> <td>H</td> <td>Enable DVCOM (internal VCOM output)</td> </tr> <tr> <td>L</td> <td>Disable DVCOM (VCOM input from external power)</td> </tr> </tbody> </table>                                                                                                                                                                                                                                                                                                                                                                                                                                                                                                                                                                   | DVCOM_EN                  | Function                  | H        | Enable DVCOM (internal VCOM output) | L | Disable DVCOM (VCOM input from external power) |   |                      |                                                |                           |                           |                                                |                           |    |                                               |        |        |        |    |        |        |      |        |    |         |        |           |        |    |        |        |   |        |
| DVCOM_EN                  | Function                                       |                                                                                                                                                                                                                                                                                                                                                                                                                                                                                                                                                                                                                                                                                                                                                                                                                                                                              |                           |                           |          |                                     |   |                                                |   |                      |                                                |                           |                           |                                                |                           |    |                                               |        |        |        |    |        |        |      |        |    |         |        |           |        |    |        |        |   |        |
| H                         | Enable DVCOM (internal VCOM output)            |                                                                                                                                                                                                                                                                                                                                                                                                                                                                                                                                                                                                                                                                                                                                                                                                                                                                              |                           |                           |          |                                     |   |                                                |   |                      |                                                |                           |                           |                                                |                           |    |                                               |        |        |        |    |        |        |      |        |    |         |        |           |        |    |        |        |   |        |
| L                         | Disable DVCOM (VCOM input from external power) |                                                                                                                                                                                                                                                                                                                                                                                                                                                                                                                                                                                                                                                                                                                                                                                                                                                                              |                           |                           |          |                                     |   |                                                |   |                      |                                                |                           |                           |                                                |                           |    |                                               |        |        |        |    |        |        |      |        |    |         |        |           |        |    |        |        |   |        |
| GIP_LRSEL[1:0]<br>(VDDIO) | Input                                          | GIP Level shift selection : <b>Normally pull high</b><br><table border="1"> <thead> <tr> <th>GIP_LRSEL[1]</th> <th>GIP_LRSEL [0]</th> <th>Function</th> </tr> </thead> <tbody> <tr> <td>0</td> <td>0</td> <td>Disable GIP level shift function</td> </tr> <tr> <td>0</td> <td>1</td> <td>Enable GIP level shift on left side(right off)</td> </tr> <tr> <td>1</td> <td>0</td> <td>Enable GIP level shift on right side(left off)</td> </tr> <tr> <td>1</td> <td>1</td> <td>Enable GIP level shift on left and right side</td> </tr> </tbody> </table> <p>GATE_SW[1:0]=[0:0] disable GIP level shift.(GIP signal pull low)</p>                                                                                                                                                                                                                                                | GIP_LRSEL[1]              | GIP_LRSEL [0]             | Function | 0                                   | 0 | Disable GIP level shift function               | 0 | 1                    | Enable GIP level shift on left side(right off) | 1                         | 0                         | Enable GIP level shift on right side(left off) | 1                         | 1  | Enable GIP level shift on left and right side |        |        |        |    |        |        |      |        |    |         |        |           |        |    |        |        |   |        |
| GIP_LRSEL[1]              | GIP_LRSEL [0]                                  | Function                                                                                                                                                                                                                                                                                                                                                                                                                                                                                                                                                                                                                                                                                                                                                                                                                                                                     |                           |                           |          |                                     |   |                                                |   |                      |                                                |                           |                           |                                                |                           |    |                                               |        |        |        |    |        |        |      |        |    |         |        |           |        |    |        |        |   |        |
| 0                         | 0                                              | Disable GIP level shift function                                                                                                                                                                                                                                                                                                                                                                                                                                                                                                                                                                                                                                                                                                                                                                                                                                             |                           |                           |          |                                     |   |                                                |   |                      |                                                |                           |                           |                                                |                           |    |                                               |        |        |        |    |        |        |      |        |    |         |        |           |        |    |        |        |   |        |
| 0                         | 1                                              | Enable GIP level shift on left side(right off)                                                                                                                                                                                                                                                                                                                                                                                                                                                                                                                                                                                                                                                                                                                                                                                                                               |                           |                           |          |                                     |   |                                                |   |                      |                                                |                           |                           |                                                |                           |    |                                               |        |        |        |    |        |        |      |        |    |         |        |           |        |    |        |        |   |        |
| 1                         | 0                                              | Enable GIP level shift on right side(left off)                                                                                                                                                                                                                                                                                                                                                                                                                                                                                                                                                                                                                                                                                                                                                                                                                               |                           |                           |          |                                     |   |                                                |   |                      |                                                |                           |                           |                                                |                           |    |                                               |        |        |        |    |        |        |      |        |    |         |        |           |        |    |        |        |   |        |
| 1                         | 1                                              | Enable GIP level shift on left and right side                                                                                                                                                                                                                                                                                                                                                                                                                                                                                                                                                                                                                                                                                                                                                                                                                                |                           |                           |          |                                     |   |                                                |   |                      |                                                |                           |                           |                                                |                           |    |                                               |        |        |        |    |        |        |      |        |    |         |        |           |        |    |        |        |   |        |
| GATE_SW[1:0]              | Input                                          | <b>Pin normally pull high</b><br><table border="1"> <thead> <tr> <th>GATE_SW [1]</th> <th>GATE_SW [0]</th> <th>Function</th> </tr> </thead> <tbody> <tr> <td>0</td> <td>0</td> <td>Reserved</td> </tr> <tr> <td>0</td> <td>1</td> <td>Internal GIP</td> </tr> <tr> <td>1</td> <td>0</td> <td>Reserved</td> </tr> <tr> <td>1</td> <td>1</td> <td>Reserved</td> </tr> </tbody> </table>                                                                                                                                                                                                                                                                                                                                                                                                                                                                                        | GATE_SW [1]               | GATE_SW [0]               | Function | 0                                   | 0 | Reserved                                       | 0 | 1                    | Internal GIP                                   | 1                         | 0                         | Reserved                                       | 1                         | 1  | Reserved                                      |        |        |        |    |        |        |      |        |    |         |        |           |        |    |        |        |   |        |
| GATE_SW [1]               | GATE_SW [0]                                    | Function                                                                                                                                                                                                                                                                                                                                                                                                                                                                                                                                                                                                                                                                                                                                                                                                                                                                     |                           |                           |          |                                     |   |                                                |   |                      |                                                |                           |                           |                                                |                           |    |                                               |        |        |        |    |        |        |      |        |    |         |        |           |        |    |        |        |   |        |
| 0                         | 0                                              | Reserved                                                                                                                                                                                                                                                                                                                                                                                                                                                                                                                                                                                                                                                                                                                                                                                                                                                                     |                           |                           |          |                                     |   |                                                |   |                      |                                                |                           |                           |                                                |                           |    |                                               |        |        |        |    |        |        |      |        |    |         |        |           |        |    |        |        |   |        |
| 0                         | 1                                              | Internal GIP                                                                                                                                                                                                                                                                                                                                                                                                                                                                                                                                                                                                                                                                                                                                                                                                                                                                 |                           |                           |          |                                     |   |                                                |   |                      |                                                |                           |                           |                                                |                           |    |                                               |        |        |        |    |        |        |      |        |    |         |        |           |        |    |        |        |   |        |
| 1                         | 0                                              | Reserved                                                                                                                                                                                                                                                                                                                                                                                                                                                                                                                                                                                                                                                                                                                                                                                                                                                                     |                           |                           |          |                                     |   |                                                |   |                      |                                                |                           |                           |                                                |                           |    |                                               |        |        |        |    |        |        |      |        |    |         |        |           |        |    |        |        |   |        |
| 1                         | 1                                              | Reserved                                                                                                                                                                                                                                                                                                                                                                                                                                                                                                                                                                                                                                                                                                                                                                                                                                                                     |                           |                           |          |                                     |   |                                                |   |                      |                                                |                           |                           |                                                |                           |    |                                               |        |        |        |    |        |        |      |        |    |         |        |           |        |    |        |        |   |        |
| INV_SEL[1:0]<br>(VDDIO)   | Input                                          | Inversion mode selection: <b>Normally pull low</b> .<br><table border="1"> <thead> <tr> <th rowspan="3">INV_SEL [1:0]</th> <th colspan="4">LVDS</th> </tr> <tr> <th colspan="2">Cascade mode<br/>(CAS=1)</th> <th colspan="2">Dual gate<br/>(CAS=0)</th> </tr> <tr> <th>Normal type<br/>(ZIGZAG=0)</th> <th>Zigzag type<br/>(ZIGZAG=1)</th> <th>Normal type<br/>(ZIGZAG=0)</th> <th>Zigzag type<br/>(ZIGZAG=1)</th> </tr> </thead> <tbody> <tr> <td>00</td> <td>1 line</td> <td>Column</td> <td>1+2dot</td> <td>Column</td> </tr> <tr> <td>01</td> <td>2 line</td> <td>Column</td> <td>2dot</td> <td>Column</td> </tr> <tr> <td>10</td> <td>1+2line</td> <td>Column</td> <td>2line2dot</td> <td>Column</td> </tr> <tr> <td>11</td> <td>Column</td> <td>Column</td> <td>-</td> <td>Column</td> </tr> </tbody> </table> <p><b>Note</b> : Four line inversion select by OTP</p> | INV_SEL [1:0]             | LVDS                      |          |                                     |   | Cascade mode<br>(CAS=1)                        |   | Dual gate<br>(CAS=0) |                                                | Normal type<br>(ZIGZAG=0) | Zigzag type<br>(ZIGZAG=1) | Normal type<br>(ZIGZAG=0)                      | Zigzag type<br>(ZIGZAG=1) | 00 | 1 line                                        | Column | 1+2dot | Column | 01 | 2 line | Column | 2dot | Column | 10 | 1+2line | Column | 2line2dot | Column | 11 | Column | Column | - | Column |
| INV_SEL [1:0]             | LVDS                                           |                                                                                                                                                                                                                                                                                                                                                                                                                                                                                                                                                                                                                                                                                                                                                                                                                                                                              |                           |                           |          |                                     |   |                                                |   |                      |                                                |                           |                           |                                                |                           |    |                                               |        |        |        |    |        |        |      |        |    |         |        |           |        |    |        |        |   |        |
|                           | Cascade mode<br>(CAS=1)                        |                                                                                                                                                                                                                                                                                                                                                                                                                                                                                                                                                                                                                                                                                                                                                                                                                                                                              |                           | Dual gate<br>(CAS=0)      |          |                                     |   |                                                |   |                      |                                                |                           |                           |                                                |                           |    |                                               |        |        |        |    |        |        |      |        |    |         |        |           |        |    |        |        |   |        |
|                           | Normal type<br>(ZIGZAG=0)                      | Zigzag type<br>(ZIGZAG=1)                                                                                                                                                                                                                                                                                                                                                                                                                                                                                                                                                                                                                                                                                                                                                                                                                                                    | Normal type<br>(ZIGZAG=0) | Zigzag type<br>(ZIGZAG=1) |          |                                     |   |                                                |   |                      |                                                |                           |                           |                                                |                           |    |                                               |        |        |        |    |        |        |      |        |    |         |        |           |        |    |        |        |   |        |
| 00                        | 1 line                                         | Column                                                                                                                                                                                                                                                                                                                                                                                                                                                                                                                                                                                                                                                                                                                                                                                                                                                                       | 1+2dot                    | Column                    |          |                                     |   |                                                |   |                      |                                                |                           |                           |                                                |                           |    |                                               |        |        |        |    |        |        |      |        |    |         |        |           |        |    |        |        |   |        |
| 01                        | 2 line                                         | Column                                                                                                                                                                                                                                                                                                                                                                                                                                                                                                                                                                                                                                                                                                                                                                                                                                                                       | 2dot                      | Column                    |          |                                     |   |                                                |   |                      |                                                |                           |                           |                                                |                           |    |                                               |        |        |        |    |        |        |      |        |    |         |        |           |        |    |        |        |   |        |
| 10                        | 1+2line                                        | Column                                                                                                                                                                                                                                                                                                                                                                                                                                                                                                                                                                                                                                                                                                                                                                                                                                                                       | 2line2dot                 | Column                    |          |                                     |   |                                                |   |                      |                                                |                           |                           |                                                |                           |    |                                               |        |        |        |    |        |        |      |        |    |         |        |           |        |    |        |        |   |        |
| 11                        | Column                                         | Column                                                                                                                                                                                                                                                                                                                                                                                                                                                                                                                                                                                                                                                                                                                                                                                                                                                                       | -                         | Column                    |          |                                     |   |                                                |   |                      |                                                |                           |                           |                                                |                           |    |                                               |        |        |        |    |        |        |      |        |    |         |        |           |        |    |        |        |   |        |
| SCAN_SEL                  | Input                                          | <table border="1"> <thead> <tr> <th>SCAN_SEL</th> <th>Function</th> </tr> </thead> <tbody> <tr> <td>H</td> <td>Inverse Z scan : G→R→G→R</td> </tr> <tr> <td>L</td> <td>Z scan : R→G→R→G(default)</td> </tr> </tbody> </table> <p><b>Note</b>: (Only for Normal dual gate type driving)<br/>Source mapping depend on external gate signal</p>                                                                                                                                                                                                                                                                                                                                                                                                                                                                                                                                 | SCAN_SEL                  | Function                  | H        | Inverse Z scan : G→R→G→R            | L | Z scan : R→G→R→G(default)                      |   |                      |                                                |                           |                           |                                                |                           |    |                                               |        |        |        |    |        |        |      |        |    |         |        |           |        |    |        |        |   |        |
| SCAN_SEL                  | Function                                       |                                                                                                                                                                                                                                                                                                                                                                                                                                                                                                                                                                                                                                                                                                                                                                                                                                                                              |                           |                           |          |                                     |   |                                                |   |                      |                                                |                           |                           |                                                |                           |    |                                               |        |        |        |    |        |        |      |        |    |         |        |           |        |    |        |        |   |        |
| H                         | Inverse Z scan : G→R→G→R                       |                                                                                                                                                                                                                                                                                                                                                                                                                                                                                                                                                                                                                                                                                                                                                                                                                                                                              |                           |                           |          |                                     |   |                                                |   |                      |                                                |                           |                           |                                                |                           |    |                                               |        |        |        |    |        |        |      |        |    |         |        |           |        |    |        |        |   |        |
| L                         | Z scan : R→G→R→G(default)                      |                                                                                                                                                                                                                                                                                                                                                                                                                                                                                                                                                                                                                                                                                                                                                                                                                                                                              |                           |                           |          |                                     |   |                                                |   |                      |                                                |                           |                           |                                                |                           |    |                                               |        |        |        |    |        |        |      |        |    |         |        |           |        |    |        |        |   |        |
| FRAME                     | Input                                          | Frame inverse or not select. <b>Normally pull low</b><br><table border="1"> <thead> <tr> <th>FRAME</th> <th>Function</th> </tr> </thead> <tbody> <tr> <td>H</td> <td>Uniform</td> </tr> <tr> <td>L</td> <td>Frame inverse(default)</td> </tr> </tbody> </table> <p><b>Note</b>: (Only for Normal dual gate type driving)<br/>INV_SEL[1:0]=[1:1] : FRAME pin function is ignored</p>                                                                                                                                                                                                                                                                                                                                                                                                                                                                                          | FRAME                     | Function                  | H        | Uniform                             | L | Frame inverse(default)                         |   |                      |                                                |                           |                           |                                                |                           |    |                                               |        |        |        |    |        |        |      |        |    |         |        |           |        |    |        |        |   |        |
| FRAME                     | Function                                       |                                                                                                                                                                                                                                                                                                                                                                                                                                                                                                                                                                                                                                                                                                                                                                                                                                                                              |                           |                           |          |                                     |   |                                                |   |                      |                                                |                           |                           |                                                |                           |    |                                               |        |        |        |    |        |        |      |        |    |         |        |           |        |    |        |        |   |        |
| H                         | Uniform                                        |                                                                                                                                                                                                                                                                                                                                                                                                                                                                                                                                                                                                                                                                                                                                                                                                                                                                              |                           |                           |          |                                     |   |                                                |   |                      |                                                |                           |                           |                                                |                           |    |                                               |        |        |        |    |        |        |      |        |    |         |        |           |        |    |        |        |   |        |
| L                         | Frame inverse(default)                         |                                                                                                                                                                                                                                                                                                                                                                                                                                                                                                                                                                                                                                                                                                                                                                                                                                                                              |                           |                           |          |                                     |   |                                                |   |                      |                                                |                           |                           |                                                |                           |    |                                               |        |        |        |    |        |        |      |        |    |         |        |           |        |    |        |        |   |        |

| Pin Name          | Pin Type                           | Description                                                                                                                                                                                                                                                                                                                                                                                                                              |         |          |   |                                   |   |                                    |
|-------------------|------------------------------------|------------------------------------------------------------------------------------------------------------------------------------------------------------------------------------------------------------------------------------------------------------------------------------------------------------------------------------------------------------------------------------------------------------------------------------------|---------|----------|---|-----------------------------------|---|------------------------------------|
| CAS               | Input                              | <p>Cascade mode selection: <b>Normally pull high</b></p> <table border="1"> <thead> <tr> <th>Cascade</th> <th>Function</th> </tr> </thead> <tbody> <tr> <td>H</td> <td>Cascade mode <b>(default)</b></td> </tr> <tr> <td>L</td> <td>Dual gate mode</td> </tr> </tbody> </table> <p>Refer to application Block diagram</p>                                                                                                                | Cascade | Function | H | Cascade mode <b>(default)</b>     | L | Dual gate mode                     |
| Cascade           | Function                           |                                                                                                                                                                                                                                                                                                                                                                                                                                          |         |          |   |                                   |   |                                    |
| H                 | Cascade mode <b>(default)</b>      |                                                                                                                                                                                                                                                                                                                                                                                                                                          |         |          |   |                                   |   |                                    |
| L                 | Dual gate mode                     |                                                                                                                                                                                                                                                                                                                                                                                                                                          |         |          |   |                                   |   |                                    |
| SDLOC             | Input                              | <p>Source driver location definition pin. <b>Normally pull high</b></p> <table border="1"> <thead> <tr> <th>SDLOC</th> <th>Function</th> </tr> </thead> <tbody> <tr> <td>H</td> <td>Source driver locate on left side</td> </tr> <tr> <td>L</td> <td>Source driver locate on right side</td> </tr> </tbody> </table> <p>Refer to application Block diagram<br/> <b>Note : internal default Master/Slave follow TP[52:51] setting</b></p> | SDLOC   | Function | H | Source driver locate on left side | L | Source driver locate on right side |
| SDLOC             | Function                           |                                                                                                                                                                                                                                                                                                                                                                                                                                          |         |          |   |                                   |   |                                    |
| H                 | Source driver locate on left side  |                                                                                                                                                                                                                                                                                                                                                                                                                                          |         |          |   |                                   |   |                                    |
| L                 | Source driver locate on right side |                                                                                                                                                                                                                                                                                                                                                                                                                                          |         |          |   |                                   |   |                                    |
| ZIGZAG            | Input                              | <p>Zigzag driving method setting. <b>Normally pull high</b></p> <table border="1"> <thead> <tr> <th>ZIGZAG</th> <th>Function</th> </tr> </thead> <tbody> <tr> <td>H</td> <td>Zigzag driving method</td> </tr> <tr> <td>L</td> <td>Normal driving method</td> </tr> </tbody> </table> <p>Refer to application Block diagram</p>                                                                                                           | ZIGZAG  | Function | H | Zigzag driving method             | L | Normal driving method              |
| ZIGZAG            | Function                           |                                                                                                                                                                                                                                                                                                                                                                                                                                          |         |          |   |                                   |   |                                    |
| H                 | Zigzag driving method              |                                                                                                                                                                                                                                                                                                                                                                                                                                          |         |          |   |                                   |   |                                    |
| L                 | Normal driving method              |                                                                                                                                                                                                                                                                                                                                                                                                                                          |         |          |   |                                   |   |                                    |
| ZTYPE             | Input                              | <p>Zigzag panel layout type selection. <b>Normally pull low</b></p> <table border="1"> <thead> <tr> <th>ZTYPE</th> <th>Function</th> </tr> </thead> <tbody> <tr> <td>H</td> <td>Zigzag layout type1</td> </tr> <tr> <td>L</td> <td>Zigzag layout type0</td> </tr> </tbody> </table> <p>Refer to application Block diagram <b>(only for CAS=H and Zigzag=H)</b></p>                                                                       | ZTYPE   | Function | H | Zigzag layout type1               | L | Zigzag layout type0                |
| ZTYPE             | Function                           |                                                                                                                                                                                                                                                                                                                                                                                                                                          |         |          |   |                                   |   |                                    |
| H                 | Zigzag layout type1                |                                                                                                                                                                                                                                                                                                                                                                                                                                          |         |          |   |                                   |   |                                    |
| L                 | Zigzag layout type0                |                                                                                                                                                                                                                                                                                                                                                                                                                                          |         |          |   |                                   |   |                                    |
| RESETB<br>(VDDIO) | Input                              | <p>Global reset pin. <b>Normally pull high.</b></p> <table border="1"> <thead> <tr> <th>RESETB</th> <th>Function</th> </tr> </thead> <tbody> <tr> <td>H</td> <td>Normal operation <b>(default)</b></td> </tr> <tr> <td>L</td> <td>The controller is in reset state</td> </tr> </tbody> </table> <p>Suggest to connecting with an RC reset circuit for stability.</p>                                                                     | RESETB  | Function | H | Normal operation <b>(default)</b> | L | The controller is in reset state   |
| RESETB            | Function                           |                                                                                                                                                                                                                                                                                                                                                                                                                                          |         |          |   |                                   |   |                                    |
| H                 | Normal operation <b>(default)</b>  |                                                                                                                                                                                                                                                                                                                                                                                                                                          |         |          |   |                                   |   |                                    |
| L                 | The controller is in reset state   |                                                                                                                                                                                                                                                                                                                                                                                                                                          |         |          |   |                                   |   |                                    |
| STBYB<br>(VDDIO)  | Input                              | <p>Standby mode. <b>Normally pull high.</b> STBYB = L, timing controller, source driver will turn off, all output are High-Z.<br/>           STBYB = H, normal operation. <b>(Default)</b></p>                                                                                                                                                                                                                                           |         |          |   |                                   |   |                                    |
| BISTB<br>(VDDIO)  | Input                              | <p>Normal Operation/BIST pattern select. <b>Normally pull high.</b></p> <table border="1"> <thead> <tr> <th>BISTB</th> <th>Function</th> </tr> </thead> <tbody> <tr> <td>H</td> <td>Normal operation <b>(default)</b></td> </tr> <tr> <td>L</td> <td>BIST mode</td> </tr> </tbody> </table>                                                                                                                                              | BISTB   | Function | H | Normal operation <b>(default)</b> | L | BIST mode                          |
| BISTB             | Function                           |                                                                                                                                                                                                                                                                                                                                                                                                                                          |         |          |   |                                   |   |                                    |
| H                 | Normal operation <b>(default)</b>  |                                                                                                                                                                                                                                                                                                                                                                                                                                          |         |          |   |                                   |   |                                    |
| L                 | BIST mode                          |                                                                                                                                                                                                                                                                                                                                                                                                                                          |         |          |   |                                   |   |                                    |
| LVFMT<br>(VDDIO)  | Input                              | <p>8-bit input format select for LVDS mode. <b>Normally pull high.</b><br/> <b>(only for LVDS)</b></p> <table border="1"> <thead> <tr> <th>LVFMT</th> <th>Function</th> </tr> </thead> <tbody> <tr> <td>H</td> <td>VESA format <b>(default)</b></td> </tr> <tr> <td>L</td> <td>JEIDA format</td> </tr> </tbody> </table>                                                                                                                 | LVFMT   | Function | H | VESA format <b>(default)</b>      | L | JEIDA format                       |
| LVFMT             | Function                           |                                                                                                                                                                                                                                                                                                                                                                                                                                          |         |          |   |                                   |   |                                    |
| H                 | VESA format <b>(default)</b>       |                                                                                                                                                                                                                                                                                                                                                                                                                                          |         |          |   |                                   |   |                                    |
| L                 | JEIDA format                       |                                                                                                                                                                                                                                                                                                                                                                                                                                          |         |          |   |                                   |   |                                    |
| LVBIT<br>(VDDIO)  | Input                              | <p>6-bit / 8-bit input select for LVDS mode. <b>Normally pull high.</b><br/> <b>(only for LVDS)</b></p> <table border="1"> <thead> <tr> <th>LVBIT</th> <th>Function</th> </tr> </thead> <tbody> <tr> <td>H</td> <td>8-bit <b>(default)</b></td> </tr> <tr> <td>L</td> <td>6-bit</td> </tr> </tbody> </table>                                                                                                                             | LVBIT   | Function | H | 8-bit <b>(default)</b>            | L | 6-bit                              |
| LVBIT             | Function                           |                                                                                                                                                                                                                                                                                                                                                                                                                                          |         |          |   |                                   |   |                                    |
| H                 | 8-bit <b>(default)</b>             |                                                                                                                                                                                                                                                                                                                                                                                                                                          |         |          |   |                                   |   |                                    |
| L                 | 6-bit                              |                                                                                                                                                                                                                                                                                                                                                                                                                                          |         |          |   |                                   |   |                                    |

| Pin Name          | Pin Type                            | Description                                                                                                                                                                                                                                                                                                                                                                                               |           |          |   |                                    |   |                                     |
|-------------------|-------------------------------------|-----------------------------------------------------------------------------------------------------------------------------------------------------------------------------------------------------------------------------------------------------------------------------------------------------------------------------------------------------------------------------------------------------------|-----------|----------|---|------------------------------------|---|-------------------------------------|
| DITHER_EN (VDDIO) | Input                               | <p>Dithering function enable control. <b>Normally pull low</b><br/>                     In LVDS 6-bit mode, IC don't care DITHER and HFRC setting.</p> <table border="1"> <thead> <tr> <th>DITHER_EN</th> <th>Function</th> </tr> </thead> <tbody> <tr> <td>H</td> <td>Enable internal dithering function</td> </tr> <tr> <td>L</td> <td>Disable internal dithering function</td> </tr> </tbody> </table> | DITHER_EN | Function | H | Enable internal dithering function | L | Disable internal dithering function |
| DITHER_EN         | Function                            |                                                                                                                                                                                                                                                                                                                                                                                                           |           |          |   |                                    |   |                                     |
| H                 | Enable internal dithering function  |                                                                                                                                                                                                                                                                                                                                                                                                           |           |          |   |                                    |   |                                     |
| L                 | Disable internal dithering function |                                                                                                                                                                                                                                                                                                                                                                                                           |           |          |   |                                    |   |                                     |
| HFRC_EN (VDDIO)   | Input                               | <p>H-FRC selection. <b>Normally pull low</b><br/>                     HFRC = H : H-FRC enable<br/>                     If "DITHER"="L", disable dithering function(HFRC and FRC disable)</p>                                                                                                                                                                                                              |           |          |   |                                    |   |                                     |
| CMD_SEL (VDDIO)   | Input                               | <p>Command interface selection. <b>Normally pull high.</b></p> <table border="1"> <thead> <tr> <th>CMD_SEL</th> <th>Function</th> </tr> </thead> <tbody> <tr> <td>H</td> <td>I2C (default)</td> </tr> <tr> <td>L</td> <td>3-Wire</td> </tr> </tbody> </table> <p>3-wire/I2C command can't receive at the same time.</p>                                                                                   | CMD_SEL   | Function | H | I2C (default)                      | L | 3-Wire                              |
| CMD_SEL           | Function                            |                                                                                                                                                                                                                                                                                                                                                                                                           |           |          |   |                                    |   |                                     |
| H                 | I2C (default)                       |                                                                                                                                                                                                                                                                                                                                                                                                           |           |          |   |                                    |   |                                     |
| L                 | 3-Wire                              |                                                                                                                                                                                                                                                                                                                                                                                                           |           |          |   |                                    |   |                                     |
| UPDN (VDDIO)      | Input                               | <p>Setting flexible GOA scan function. <b>Normally pull low.</b><br/>                     If "UPDN"="H", support backward scan<br/>                     If "UPDN"="L", support forward scan<br/>                     (Forward/Backward Flexible GOA setting by Reg.)</p>                                                                                                                                  |           |          |   |                                    |   |                                     |
| A0                | Input                               | <p>Serial interface (I2C) Compatible Device Address Bit 0 input.<br/> <b>Normally pull high.</b></p>                                                                                                                                                                                                                                                                                                      |           |          |   |                                    |   |                                     |
| LEDON             | Output                              | <p>Back-light enable signal.<br/>                     Note:<br/>                     Available at normal display<br/>                     unused floating.</p>                                                                                                                                                                                                                                            |           |          |   |                                    |   |                                     |
| CSB (VDDIO)       | Input                               | <p>Serial communication enables. <b>Normally pull high</b><br/>                     Note: unused floating</p>                                                                                                                                                                                                                                                                                             |           |          |   |                                    |   |                                     |
| SCL (VDDIO)       | Input                               | <p>Serial communication clock input.<br/>                     Note: unused floating</p>                                                                                                                                                                                                                                                                                                                   |           |          |   |                                    |   |                                     |
| SDA (VDDIO)       | I/O                                 | <p>Serial communication data input.<br/>                     Note: unused floating</p>                                                                                                                                                                                                                                                                                                                    |           |          |   |                                    |   |                                     |
| SCL_I2C (VDDIO)   | Input                               | <p>Serial communication clock input.<br/>                     Note: unused floating</p>                                                                                                                                                                                                                                                                                                                   |           |          |   |                                    |   |                                     |
| SDA_I2C (VDDIO)   | I/O                                 | <p>Serial communication data input.<br/>                     Note: unused floating</p>                                                                                                                                                                                                                                                                                                                    |           |          |   |                                    |   |                                     |
| PWR_EN            | Output                              | <p>Enable power for external power IC<br/>                     Note: unused floating</p>                                                                                                                                                                                                                                                                                                                  |           |          |   |                                    |   |                                     |

| Panel driver output                                              |                           |                                                                                                                                                                                                                                                                                                                                                                                                                                                                                                                                                                                                                                                                                                                                                                                                                                                                                                                                                                                                |                           |                    |                 |                    |           |                |                 |                           |                 |             |                           |             |            |                           |             |                           |                           |                           |             |             |                           |             |                           |             |            |                           |             |                           |             |            |                           |             |
|------------------------------------------------------------------|---------------------------|------------------------------------------------------------------------------------------------------------------------------------------------------------------------------------------------------------------------------------------------------------------------------------------------------------------------------------------------------------------------------------------------------------------------------------------------------------------------------------------------------------------------------------------------------------------------------------------------------------------------------------------------------------------------------------------------------------------------------------------------------------------------------------------------------------------------------------------------------------------------------------------------------------------------------------------------------------------------------------------------|---------------------------|--------------------|-----------------|--------------------|-----------|----------------|-----------------|---------------------------|-----------------|-------------|---------------------------|-------------|------------|---------------------------|-------------|---------------------------|---------------------------|---------------------------|-------------|-------------|---------------------------|-------------|---------------------------|-------------|------------|---------------------------|-------------|---------------------------|-------------|------------|---------------------------|-------------|
| S[2051:0]                                                        | Output                    | Source output mapping with different resolution.2051<br>Source output control by RES[2:0] pin define<br><b>On Dual gate mode : CAS=0</b>                                                                                                                                                                                                                                                                                                                                                                                                                                                                                                                                                                                                                                                                                                                                                                                                                                                       |                           |                    |                 |                    |           |                |                 |                           |                 |             |                           |             |            |                           |             |                           |                           |                           |             |             |                           |             |                           |             |            |                           |             |                           |             |            |                           |             |
|                                                                  |                           | <table border="1"> <thead> <tr> <th>Resolution</th> <th>Source channel</th> <th>Disable channel</th> </tr> </thead> <tbody> <tr> <td>1366RGBx768</td> <td>S[2051:0]</td> <td>-</td> </tr> <tr> <td>1280RGBx800</td> <td>S[959:0] and S[2051:1092]</td> <td>S[1091:960]</td> </tr> <tr> <td>1024RGBx600</td> <td>S[767:0] and S[2051:1284]</td> <td>S[1283:768]</td> </tr> <tr> <td>960RGBx640</td> <td>S[719:0] and S[2051:1332]</td> <td>S[1331:720]</td> </tr> <tr> <td>800RGBx600</td> <td>S[599:0] and S[2051:1452]</td> <td>S[1451:600]</td> </tr> </tbody> </table>                                                                                                                                                                                                                                                                                                                                                                                                                      | Resolution                | Source channel     | Disable channel | 1366RGBx768        | S[2051:0] | -              | 1280RGBx800     | S[959:0] and S[2051:1092] | S[1091:960]     | 1024RGBx600 | S[767:0] and S[2051:1284] | S[1283:768] | 960RGBx640 | S[719:0] and S[2051:1332] | S[1331:720] | 800RGBx600                | S[599:0] and S[2051:1452] | S[1451:600]               |             |             |                           |             |                           |             |            |                           |             |                           |             |            |                           |             |
|                                                                  |                           | Resolution                                                                                                                                                                                                                                                                                                                                                                                                                                                                                                                                                                                                                                                                                                                                                                                                                                                                                                                                                                                     | Source channel            | Disable channel    |                 |                    |           |                |                 |                           |                 |             |                           |             |            |                           |             |                           |                           |                           |             |             |                           |             |                           |             |            |                           |             |                           |             |            |                           |             |
|                                                                  |                           | 1366RGBx768                                                                                                                                                                                                                                                                                                                                                                                                                                                                                                                                                                                                                                                                                                                                                                                                                                                                                                                                                                                    | S[2051:0]                 | -                  |                 |                    |           |                |                 |                           |                 |             |                           |             |            |                           |             |                           |                           |                           |             |             |                           |             |                           |             |            |                           |             |                           |             |            |                           |             |
|                                                                  |                           | 1280RGBx800                                                                                                                                                                                                                                                                                                                                                                                                                                                                                                                                                                                                                                                                                                                                                                                                                                                                                                                                                                                    | S[959:0] and S[2051:1092] | S[1091:960]        |                 |                    |           |                |                 |                           |                 |             |                           |             |            |                           |             |                           |                           |                           |             |             |                           |             |                           |             |            |                           |             |                           |             |            |                           |             |
|                                                                  |                           | 1024RGBx600                                                                                                                                                                                                                                                                                                                                                                                                                                                                                                                                                                                                                                                                                                                                                                                                                                                                                                                                                                                    | S[767:0] and S[2051:1284] | S[1283:768]        |                 |                    |           |                |                 |                           |                 |             |                           |             |            |                           |             |                           |                           |                           |             |             |                           |             |                           |             |            |                           |             |                           |             |            |                           |             |
|                                                                  |                           | 960RGBx640                                                                                                                                                                                                                                                                                                                                                                                                                                                                                                                                                                                                                                                                                                                                                                                                                                                                                                                                                                                     | S[719:0] and S[2051:1332] | S[1331:720]        |                 |                    |           |                |                 |                           |                 |             |                           |             |            |                           |             |                           |                           |                           |             |             |                           |             |                           |             |            |                           |             |                           |             |            |                           |             |
|                                                                  |                           | 800RGBx600                                                                                                                                                                                                                                                                                                                                                                                                                                                                                                                                                                                                                                                                                                                                                                                                                                                                                                                                                                                     | S[599:0] and S[2051:1452] | S[1451:600]        |                 |                    |           |                |                 |                           |                 |             |                           |             |            |                           |             |                           |                           |                           |             |             |                           |             |                           |             |            |                           |             |                           |             |            |                           |             |
|                                                                  |                           | <b>On Cascade mode : CAS=1(single gate)</b>                                                                                                                                                                                                                                                                                                                                                                                                                                                                                                                                                                                                                                                                                                                                                                                                                                                                                                                                                    |                           |                    |                 |                    |           |                |                 |                           |                 |             |                           |             |            |                           |             |                           |                           |                           |             |             |                           |             |                           |             |            |                           |             |                           |             |            |                           |             |
|                                                                  |                           | <table border="1"> <thead> <tr> <th rowspan="2">Resolution</th> <th colspan="2">Chip on left side</th> <th colspan="2">Chip on right side</th> </tr> <tr> <th>Source channel</th> <th>Disable channel</th> <th>Source channel</th> <th>Disable channel</th> </tr> </thead> <tbody> <tr> <td>1366RGBx768</td> <td>S[2051:0]</td> <td>-</td> <td>S[2051:0]</td> <td>-</td> </tr> <tr> <td>1280RGBx800</td> <td>S[959:0] and S[2051:1092]</td> <td>S[1091:960]</td> <td>S[959:0] and S[2051:1092]</td> <td>S[1091:960]</td> </tr> <tr> <td>1024RGBx600</td> <td>S[767:0] and S[2051:1284]</td> <td>S[1283:768]</td> <td>S[767:0] and S[2051:1284]</td> <td>S[1283:768]</td> </tr> <tr> <td>960RGBx640</td> <td>S[719:0] and S[2051:1332]</td> <td>S[1331:720]</td> <td>S[719:0] and S[2051:1332]</td> <td>S[1331:720]</td> </tr> <tr> <td>800RGBx600</td> <td>S[599:0] and S[2051:1452]</td> <td>S[1451:600]</td> <td>S[599:0] and S[2051:1452]</td> <td>S[1451:600]</td> </tr> </tbody> </table> | Resolution                | Chip on left side  |                 | Chip on right side |           | Source channel | Disable channel | Source channel            | Disable channel | 1366RGBx768 | S[2051:0]                 | -           | S[2051:0]  | -                         | 1280RGBx800 | S[959:0] and S[2051:1092] | S[1091:960]               | S[959:0] and S[2051:1092] | S[1091:960] | 1024RGBx600 | S[767:0] and S[2051:1284] | S[1283:768] | S[767:0] and S[2051:1284] | S[1283:768] | 960RGBx640 | S[719:0] and S[2051:1332] | S[1331:720] | S[719:0] and S[2051:1332] | S[1331:720] | 800RGBx600 | S[599:0] and S[2051:1452] | S[1451:600] |
| Resolution                                                       | Chip on left side         |                                                                                                                                                                                                                                                                                                                                                                                                                                                                                                                                                                                                                                                                                                                                                                                                                                                                                                                                                                                                |                           | Chip on right side |                 |                    |           |                |                 |                           |                 |             |                           |             |            |                           |             |                           |                           |                           |             |             |                           |             |                           |             |            |                           |             |                           |             |            |                           |             |
|                                                                  | Source channel            | Disable channel                                                                                                                                                                                                                                                                                                                                                                                                                                                                                                                                                                                                                                                                                                                                                                                                                                                                                                                                                                                | Source channel            | Disable channel    |                 |                    |           |                |                 |                           |                 |             |                           |             |            |                           |             |                           |                           |                           |             |             |                           |             |                           |             |            |                           |             |                           |             |            |                           |             |
| 1366RGBx768                                                      | S[2051:0]                 | -                                                                                                                                                                                                                                                                                                                                                                                                                                                                                                                                                                                                                                                                                                                                                                                                                                                                                                                                                                                              | S[2051:0]                 | -                  |                 |                    |           |                |                 |                           |                 |             |                           |             |            |                           |             |                           |                           |                           |             |             |                           |             |                           |             |            |                           |             |                           |             |            |                           |             |
| 1280RGBx800                                                      | S[959:0] and S[2051:1092] | S[1091:960]                                                                                                                                                                                                                                                                                                                                                                                                                                                                                                                                                                                                                                                                                                                                                                                                                                                                                                                                                                                    | S[959:0] and S[2051:1092] | S[1091:960]        |                 |                    |           |                |                 |                           |                 |             |                           |             |            |                           |             |                           |                           |                           |             |             |                           |             |                           |             |            |                           |             |                           |             |            |                           |             |
| 1024RGBx600                                                      | S[767:0] and S[2051:1284] | S[1283:768]                                                                                                                                                                                                                                                                                                                                                                                                                                                                                                                                                                                                                                                                                                                                                                                                                                                                                                                                                                                    | S[767:0] and S[2051:1284] | S[1283:768]        |                 |                    |           |                |                 |                           |                 |             |                           |             |            |                           |             |                           |                           |                           |             |             |                           |             |                           |             |            |                           |             |                           |             |            |                           |             |
| 960RGBx640                                                       | S[719:0] and S[2051:1332] | S[1331:720]                                                                                                                                                                                                                                                                                                                                                                                                                                                                                                                                                                                                                                                                                                                                                                                                                                                                                                                                                                                    | S[719:0] and S[2051:1332] | S[1331:720]        |                 |                    |           |                |                 |                           |                 |             |                           |             |            |                           |             |                           |                           |                           |             |             |                           |             |                           |             |            |                           |             |                           |             |            |                           |             |
| 800RGBx600                                                       | S[599:0] and S[2051:1452] | S[1451:600]                                                                                                                                                                                                                                                                                                                                                                                                                                                                                                                                                                                                                                                                                                                                                                                                                                                                                                                                                                                    | S[599:0] and S[2051:1452] | S[1451:600]        |                 |                    |           |                |                 |                           |                 |             |                           |             |            |                           |             |                           |                           |                           |             |             |                           |             |                           |             |            |                           |             |                           |             |            |                           |             |
| <b>Note:</b><br>Chip position refer to application Block diagram |                           |                                                                                                                                                                                                                                                                                                                                                                                                                                                                                                                                                                                                                                                                                                                                                                                                                                                                                                                                                                                                |                           |                    |                 |                    |           |                |                 |                           |                 |             |                           |             |            |                           |             |                           |                           |                           |             |             |                           |             |                           |             |            |                           |             |                           |             |            |                           |             |
| GOUTL[1]~GOUTL[22]                                               | Output                    | These pins are used for Panel gate control signals. If not used, let it open.                                                                                                                                                                                                                                                                                                                                                                                                                                                                                                                                                                                                                                                                                                                                                                                                                                                                                                                  |                           |                    |                 |                    |           |                |                 |                           |                 |             |                           |             |            |                           |             |                           |                           |                           |             |             |                           |             |                           |             |            |                           |             |                           |             |            |                           |             |
| GOUTR[1]~GOUTR[22]                                               | Output                    | These pins are used for Panel gate control signals. If not used, let it open.                                                                                                                                                                                                                                                                                                                                                                                                                                                                                                                                                                                                                                                                                                                                                                                                                                                                                                                  |                           |                    |                 |                    |           |                |                 |                           |                 |             |                           |             |            |                           |             |                           |                           |                           |             |             |                           |             |                           |             |            |                           |             |                           |             |            |                           |             |
| Power                                                            |                           |                                                                                                                                                                                                                                                                                                                                                                                                                                                                                                                                                                                                                                                                                                                                                                                                                                                                                                                                                                                                |                           |                    |                 |                    |           |                |                 |                           |                 |             |                           |             |            |                           |             |                           |                           |                           |             |             |                           |             |                           |             |            |                           |             |                           |             |            |                           |             |
| VDD                                                              | PI                        | A power supply for analog circuit. VDD=2.3V to 3.6V                                                                                                                                                                                                                                                                                                                                                                                                                                                                                                                                                                                                                                                                                                                                                                                                                                                                                                                                            |                           |                    |                 |                    |           |                |                 |                           |                 |             |                           |             |            |                           |             |                           |                           |                           |             |             |                           |             |                           |             |            |                           |             |                           |             |            |                           |             |
| VDDIO                                                            | PI                        | A power supply for the I/O circuit. VDDIO=2.3V to 3.6V                                                                                                                                                                                                                                                                                                                                                                                                                                                                                                                                                                                                                                                                                                                                                                                                                                                                                                                                         |                           |                    |                 |                    |           |                |                 |                           |                 |             |                           |             |            |                           |             |                           |                           |                           |             |             |                           |             |                           |             |            |                           |             |                           |             |            |                           |             |
| VDD_15V                                                          | PO                        | Internal power supply for logic circuits. Connect to a stabilizing capacitor.                                                                                                                                                                                                                                                                                                                                                                                                                                                                                                                                                                                                                                                                                                                                                                                                                                                                                                                  |                           |                    |                 |                    |           |                |                 |                           |                 |             |                           |             |            |                           |             |                           |                           |                           |             |             |                           |             |                           |             |            |                           |             |                           |             |            |                           |             |
| VDD_15V_IF                                                       | PO                        | Internal power supply for LVDS circuits. Connect to a stabilizing capacitor.                                                                                                                                                                                                                                                                                                                                                                                                                                                                                                                                                                                                                                                                                                                                                                                                                                                                                                                   |                           |                    |                 |                    |           |                |                 |                           |                 |             |                           |             |            |                           |             |                           |                           |                           |             |             |                           |             |                           |             |            |                           |             |                           |             |            |                           |             |
| VDD_IF                                                           | PI                        | Interface and I/O power supply for the LVDS power regulator circuits. VDDIO=2.3V to 3.6V.                                                                                                                                                                                                                                                                                                                                                                                                                                                                                                                                                                                                                                                                                                                                                                                                                                                                                                      |                           |                    |                 |                    |           |                |                 |                           |                 |             |                           |             |            |                           |             |                           |                           |                           |             |             |                           |             |                           |             |            |                           |             |                           |             |            |                           |             |
| VSS                                                              | PI                        | GND for the internal logic. VSS=0V. When using the COG method, connect to VSSA on the FPC to prevent noise.                                                                                                                                                                                                                                                                                                                                                                                                                                                                                                                                                                                                                                                                                                                                                                                                                                                                                    |                           |                    |                 |                    |           |                |                 |                           |                 |             |                           |             |            |                           |             |                           |                           |                           |             |             |                           |             |                           |             |            |                           |             |                           |             |            |                           |             |
| VSS_IF                                                           | PI                        | Ground for interface.                                                                                                                                                                                                                                                                                                                                                                                                                                                                                                                                                                                                                                                                                                                                                                                                                                                                                                                                                                          |                           |                    |                 |                    |           |                |                 |                           |                 |             |                           |             |            |                           |             |                           |                           |                           |             |             |                           |             |                           |             |            |                           |             |                           |             |            |                           |             |
| VSSA                                                             | PI                        | Analog ground. VSS=0V. When using the COG method, connect to VSS on the FPC to prevent noise.                                                                                                                                                                                                                                                                                                                                                                                                                                                                                                                                                                                                                                                                                                                                                                                                                                                                                                  |                           |                    |                 |                    |           |                |                 |                           |                 |             |                           |             |            |                           |             |                           |                           |                           |             |             |                           |             |                           |             |            |                           |             |                           |             |            |                           |             |
| VSP                                                              | PI                        | Input voltage from the set-up circuit (4.5V to 6.0V).                                                                                                                                                                                                                                                                                                                                                                                                                                                                                                                                                                                                                                                                                                                                                                                                                                                                                                                                          |                           |                    |                 |                    |           |                |                 |                           |                 |             |                           |             |            |                           |             |                           |                           |                           |             |             |                           |             |                           |             |            |                           |             |                           |             |            |                           |             |
| VSN                                                              | PI                        | Input voltage from the set-up circuit (-4.5V to -6.0V).                                                                                                                                                                                                                                                                                                                                                                                                                                                                                                                                                                                                                                                                                                                                                                                                                                                                                                                                        |                           |                    |                 |                    |           |                |                 |                           |                 |             |                           |             |            |                           |             |                           |                           |                           |             |             |                           |             |                           |             |            |                           |             |                           |             |            |                           |             |
| VGMP                                                             | PO                        | Positive regulated voltage output (3.728V to 5.76V)                                                                                                                                                                                                                                                                                                                                                                                                                                                                                                                                                                                                                                                                                                                                                                                                                                                                                                                                            |                           |                    |                 |                    |           |                |                 |                           |                 |             |                           |             |            |                           |             |                           |                           |                           |             |             |                           |             |                           |             |            |                           |             |                           |             |            |                           |             |
| VGMN                                                             | PO                        | Negative regulated voltage output (-3.728V to -5.76V)                                                                                                                                                                                                                                                                                                                                                                                                                                                                                                                                                                                                                                                                                                                                                                                                                                                                                                                                          |                           |                    |                 |                    |           |                |                 |                           |                 |             |                           |             |            |                           |             |                           |                           |                           |             |             |                           |             |                           |             |            |                           |             |                           |             |            |                           |             |
| VGH                                                              | PI                        | Connect to stabilizing capacitor between VSSA and VGH.                                                                                                                                                                                                                                                                                                                                                                                                                                                                                                                                                                                                                                                                                                                                                                                                                                                                                                                                         |                           |                    |                 |                    |           |                |                 |                           |                 |             |                           |             |            |                           |             |                           |                           |                           |             |             |                           |             |                           |             |            |                           |             |                           |             |            |                           |             |
| VGL                                                              | PI                        | Connect to stabilizing capacitor between VSSA and VGL.                                                                                                                                                                                                                                                                                                                                                                                                                                                                                                                                                                                                                                                                                                                                                                                                                                                                                                                                         |                           |                    |                 |                    |           |                |                 |                           |                 |             |                           |             |            |                           |             |                           |                           |                           |             |             |                           |             |                           |             |            |                           |             |                           |             |            |                           |             |
| VGH_REG                                                          | PO                        | Regulator output voltage generated from VGH. Connect to a stabilizing capacitor between VSSA and VGH_REG. If not used, please open.                                                                                                                                                                                                                                                                                                                                                                                                                                                                                                                                                                                                                                                                                                                                                                                                                                                            |                           |                    |                 |                    |           |                |                 |                           |                 |             |                           |             |            |                           |             |                           |                           |                           |             |             |                           |             |                           |             |            |                           |             |                           |             |            |                           |             |
| VGL_REG                                                          | PO                        | Regulator output voltage generated from VGL. Connect to a stabilizing capacitor between VSSA and VGL_REG. If not used, please open.                                                                                                                                                                                                                                                                                                                                                                                                                                                                                                                                                                                                                                                                                                                                                                                                                                                            |                           |                    |                 |                    |           |                |                 |                           |                 |             |                           |             |            |                           |             |                           |                           |                           |             |             |                           |             |                           |             |            |                           |             |                           |             |            |                           |             |
| VCL                                                              | PO                        | Input voltage from the set-up circuit(VSN+2.4V). It is generated from VSN.                                                                                                                                                                                                                                                                                                                                                                                                                                                                                                                                                                                                                                                                                                                                                                                                                                                                                                                     |                           |                    |                 |                    |           |                |                 |                           |                 |             |                           |             |            |                           |             |                           |                           |                           |             |             |                           |             |                           |             |            |                           |             |                           |             |            |                           |             |
| VCOM                                                             | PO                        | The power supply of common voltage in DC com driving. The voltage range is set between -0.55V to -2.46V. It must connected a stabilizing capacitor 2.2u to VSS.                                                                                                                                                                                                                                                                                                                                                                                                                                                                                                                                                                                                                                                                                                                                                                                                                                |                           |                    |                 |                    |           |                |                 |                           |                 |             |                           |             |            |                           |             |                           |                           |                           |             |             |                           |             |                           |             |            |                           |             |                           |             |            |                           |             |

| Other pins          |     |                                                                          |
|---------------------|-----|--------------------------------------------------------------------------|
| PASS1_R/PASS2_R     | -   | Pass line                                                                |
| PASS1_L/PASS2_L     | -   | Pass line                                                                |
| SYNC_L[4:0]         | I/O | Sync signal for IC control.<br><b>Refer to application Block diagram</b> |
| SYNC_R[4:0]         | I/O | Sync signal for IC control.<br><b>Refer to application Block diagram</b> |
| T_S[114]/T_S[115]   | O   | Source channel output pin.                                               |
| T_S[1195]/T_S[1196] | O   | Source channel output pin.                                               |
| DUMMY               | T   | Test pin. Float these pins for normal operation.                         |
| TP[77:0]            | T   | Test pin. Float these pins for normal operation.                         |
| T_VTSEN[2:0]        | T   | Test pin. Float these pins for normal operation.                         |

Note: P: Power, D: Dummy, S: Shorted line, M: Mark, PI: Power input, PO: Power output, T: Testing, SH: Shielding, PS: Power Setting, C: Capacitor pin.

FITIPOWER CONFIDENTIAL  
 NO DISCLOSURE

## 6.2 Value of wiring resistance to each pin

The recommended wiring resistance values are shown below. The wiring resistance values affect the current capacity of the power supply, so be sure to design using values that do not exceed those recommended.

Source wiring:

| Pin name                     | Wiring resistance value(Ω) | Pin name            | Wiring resistance value(Ω) |
|------------------------------|----------------------------|---------------------|----------------------------|
| VDD                          | < 5                        | T_VTSEN[2]          | < 100                      |
| VDD_IF                       | < 5                        | T_VTSEN[1]          | < 100                      |
| VDDIO                        | < 5                        | T_VTSEN[0]          | < 100                      |
| VDD_15V                      | < 5                        | DUMMY               | < 100                      |
| VDD_15V_IF                   | < 5                        | SHIELDING           | < 100                      |
| VSP                          | < 5                        | DP[0]/DN[0]         | < 5                        |
| VSN                          | < 5                        | DP[1]/DN[1]         | < 5                        |
| VGH                          | < 5                        | DP[2]/DN[2]         | < 5                        |
| VGL                          | < 5                        | DP[3]/DN[3]         | < 5                        |
| VGMP                         | < 5                        | CKP/CKN             | < 5                        |
| VGMN                         | < 5                        | DIR                 | <100                       |
| VGH_REG                      | < 5                        | GOUTR[1]~GOUTR[22]  | < 50                       |
| VGL_REG                      | < 5                        | GOUTL[1]~GOUTL[22]  | < 50                       |
| VCOM                         | < 5                        | SCL                 | < 50                       |
| VSSA                         | < 5                        | SDA                 | < 50                       |
| VSS_IF                       | < 5                        | SCL_I2C             | < 50                       |
| VSS                          | < 5                        | SDA_I2C             | < 50                       |
| RES[2:0]                     | < 100                      | VCL                 | < 5                        |
| STBYB                        | < 100                      | CMD_SEL             | < 100                      |
| RESETB                       | < 100                      | LNSW[1:0]           | < 100                      |
| PNSW                         | < 100                      | GATE_SW[1:0]        | < 100                      |
| REV                          | < 100                      | SYNC_R[0]~SYNC_R[4] | < 100                      |
| LVFMT                        | < 100                      | SYNC_L[0]~SYNC_L[4] | < 100                      |
| LVBIT                        | < 100                      | UPDN                | < 100                      |
| IFSEL[1:0]                   | < 100                      | CSB                 | < 50                       |
| DVCOM_WP                     | < 100                      | TP                  | <100                       |
| CS_SD                        | < 100                      | ZIGZAG              | <100                       |
| CS_GIP                       | < 100                      | ZTYPE               | <100                       |
| BISTB                        | < 100                      | HFRC_EN             | <100                       |
| LEDPWM                       | < 50                       | FRAME               | <100                       |
| LEDON                        | < 50                       | A0                  | <100                       |
| SDLOC                        | <100                       | DVCOM_EN            | <100                       |
| DITHER_EN                    | <100                       | PWR_EN              | <100                       |
| SCAN_SEL                     | <100                       | INV_SEL             | <100                       |
| T_S[1996:1995]/ T_S[115:114] | <50                        | CAS                 | <100                       |
| OP_DRV                       | <100                       | GIP_LRSEL           | <100                       |



## 6.3 GOUT Power domain for GIP Application

| -         | Pad Power Domian |
|-----------|------------------|
| GOUTR[1]  | VGH~VGL_REG      |
| GOUTR[2]  | VGH~VGL_REG      |
| GOUTR[3]  | VGH~VGL          |
| GOUTR[4]  | VGH~VGL          |
| GOUTR[5]  | VGH~VGL          |
| GOUTR[6]  | VGH~VGL          |
| GOUTR[7]  | VGH~VGL          |
| GOUTR[8]  | VGH~VGL          |
| GOUTR[9]  | VGH~VGL          |
| GOUTR[10] | VGH~VGL          |
| GOUTR[11] | VGH~VGL          |
| GOUTR[12] | VGH~VGL          |
| GOUTR[13] | VGH~VGL          |
| GOUTR[14] | VGH~VGL          |
| GOUTR[15] | VGH~VGL          |
| GOUTR[16] | VGH~VGL          |
| GOUTR[17] | VGH~VGL          |
| GOUTR[18] | VGH~VGL          |
| GOUTR[19] | VGH~VGL          |
| GOUTR[20] | VGH~VGL          |
| GOUTR[21] | VGH~VGL          |
| GOUTR[22] | VGH~VGL          |

| -         | Pad Power Domian |
|-----------|------------------|
| GOUTL[1]  | VGH~VGL_REG      |
| GOUTL[2]  | VGH~VGL_REG      |
| GOUTL[3]  | VGH~VGL          |
| GOUTL[4]  | VGH~VGL          |
| GOUTL[5]  | VGH~VGL          |
| GOUTL[6]  | VGH~VGL          |
| GOUTL[7]  | VGH~VGL          |
| GOUTL[8]  | VGH~VGL          |
| GOUTL[9]  | VGH~VGL          |
| GOUTL[10] | VGH~VGL          |
| GOUTL[11] | VGH~VGL          |
| GOUTL[12] | VGH~VGL          |
| GOUTL[13] | VGH~VGL          |
| GOUTL[14] | VGH~VGL          |
| GOUTL[15] | VGH~VGL          |
| GOUTL[16] | VGH~VGL          |
| GOUTL[17] | VGH~VGL          |
| GOUTL[18] | VGH~VGL          |
| GOUTL[19] | VGH~VGL          |
| GOUTL[20] | VGH~VGL          |
| GOUTL[21] | VGH~VGL          |
| GOUTL[22] | VGH~VGL          |

FITIPOWER CONFIDENTIAL

## 7. Register Command Format

The EK79202 supports set internal register by I2C interface. I2C interface use different register address.. The SPI and I2C must be ignored its. "SPI/I2C address" showed in register table.

### 7.1 I2C format

The I<sup>2</sup>C-bus is for bi-directional, two-line communication between different Ics or modules. The two lines are the Serial Data line (I<sup>2</sup>C\_SDA) and the Serial Clock Line (I<sup>2</sup>C\_SCL). Both lines must be connected to a positive supply via pull-up resistors. Data transfer can be initiated only when the bus is not busy. Each byte of eight bits is followed by an acknowledge bit. The acknowledge bit is a HIGH level signal put on the bus by the transmitter during which time the master generates an extra acknowledgement related clock pulse. A slave receiver which is addressed must generate an acknowledgement after the reception of each byte. Also a master receiver must generate an acknowledgement after the reception of each byte that has been clocked out of the slave transmitter.

#### I<sup>2</sup>C-Bus Protocol:

Before any data is transmitted on the I<sup>2</sup>C-bus, the device which should respond is addressed first. There are four slave address can be selected by MCU. The slave addressing is always carried out with the first byte transmitted after the START procedure.

#### Definitions:

- Transmitter: The device which sends the data to the bus.
- Receiver: The device which receives the data from the bus.
- Master: The device which initiates a transfer, generates clock signals and terminates a transfer.
- Slave: The device addressed by a master.
- Multi-master: More than one master can attempt to control the bus at the same time without corrupting the message.
- Arbitration: Procedure to ensure that, if more than one master simultaneously tries to control the bus, only one is allowed to do so and the message is not corrupted.
- Synchronization: Procedure to synchronize the clock signals of two or more devices.

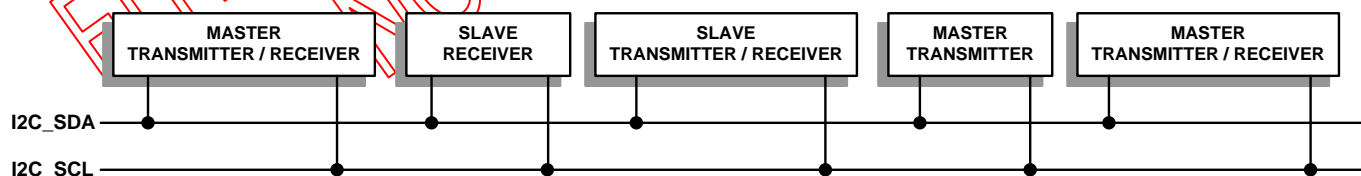

### 7.1.1 Register Write Sequence of I<sup>2</sup>C Interface

EK79202 supports register write sequence via I<sup>2</sup>C-bus transfer. The register writing support single register write mode and multi-register write mode. The detail transference sequences are illustrated and described as below.

- (1) Data transfers for register writing follow the format is shown in below.
- (2) After the START condition (S), a slave address is sent. R/W bit is setting to "0" for WRITE.
- (3) The slave issues an ACK to master.
- (4) 8 bits register address transfer first then transfer the register data parameter.
- (5) A data transfer is always terminated by a STOP condition.
- (6) EK79202 DA[6:0]=100\_1111 or DA[6:0]=100\_1110

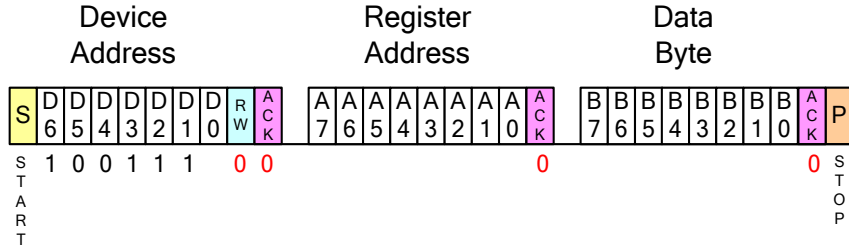

Single Register Writing Timing

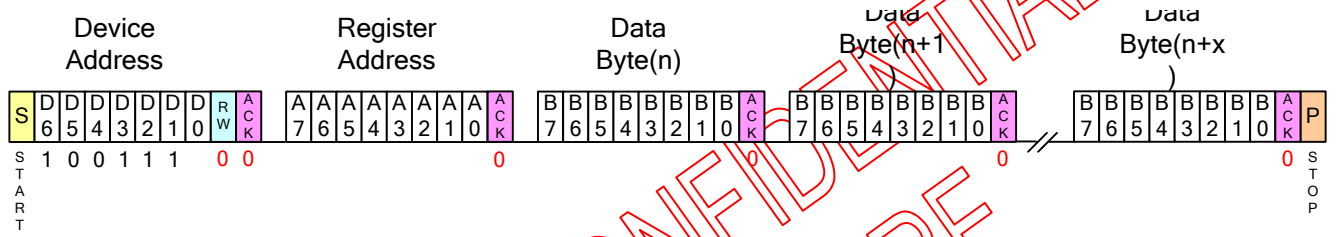

Multi Register Writing Timing

7.1.2 Register Read Sequence of I2C Interface

EK79202 supports register read sequence via I<sup>2</sup>C-bus transfer. The register reading only support single register read mode. Register data reading transfers follow the format and is shown in below.

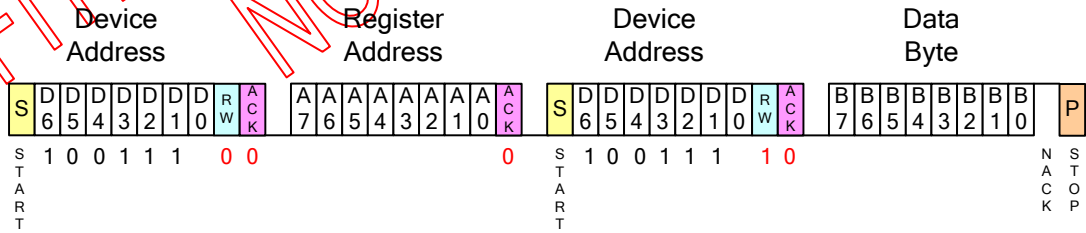

Single Register Reading Timing

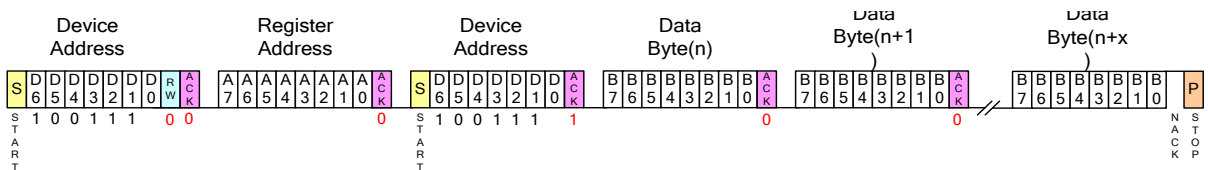

Multi Register Reading Timing

## 7.2 SPI format

EK79202 use the 3-wire serial port as communication interface for all the function and command setting.

3-Wire communication can be bi-directional controlled by the “R/W” bit in address field. EK79202 3-Wire engine act as a “slave mode” for all the time, and will not issue any command to the 3-Wire bus itself.

Under read mode, 3-Wire engine will return the data during “Data phase”. The returned data should be latched at the rising edge of SCL by external controller. Data in the “Hi-Z phase” will be ignored by 3-Wire engine during write operation, and should be ignored during read operation also. During read operation, external controller should float SDA pin under “Hi-Z phase” and “Data phase”.

Each Read/Write operation should be exactly 16 bit. To prevent from incorrect setting of the internal register, any write operation with more or less than 16 bit data during a CSB Low period will be ignored by 3-Wire engine.

For prevent from incorrect setting of the internal register. Please refer to the section of “3-Wire Timing. Because the 3-wire only can read/write one address. So we put the “parameter index” at the address 0x2F. When 3-wire command sends, it will refer to the address 0x2F[4:0] as the parameter index value.

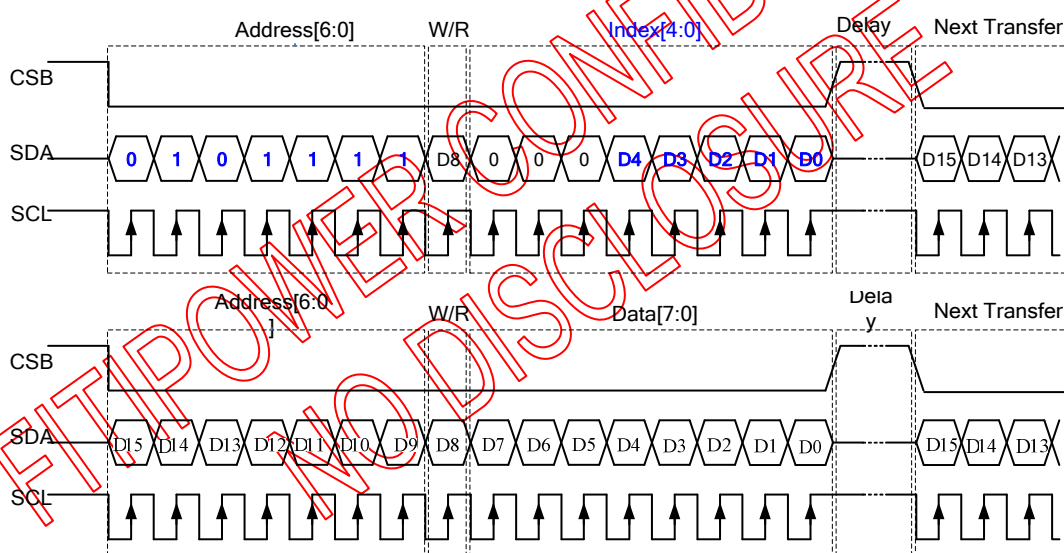

### 3-Wire Command Format:

| Bit    | Description                                                          |
|--------|----------------------------------------------------------------------|
| D15-D9 | Register Address [6:0].                                              |
| D8     | W/R control bit. “0” for Write; “1” for Read                         |
| D7-D0  | Data for the W/R operation to the address indicated by Address phase |

### 3-Wire Writer Format:

| MSB                    |     |     |     |     |     |    |    |                                     |    |    |    |    |    | LSB |    |
|------------------------|-----|-----|-----|-----|-----|----|----|-------------------------------------|----|----|----|----|----|-----|----|
| D15                    | D14 | D13 | D12 | D11 | D10 | D9 | D8 | D7                                  | D6 | D5 | D4 | D3 | D2 | D1  | D0 |
| Register Address [6:0] |     |     |     |     |     |    | 0  | Data (Issue by external controller) |    |    |    |    |    |     |    |

### 3-Wire Read Format:

| MSB                    |     |     |     |     |     |    |    |                               |    |    |    |    |    | LSB |    |
|------------------------|-----|-----|-----|-----|-----|----|----|-------------------------------|----|----|----|----|----|-----|----|
| D15                    | D14 | D13 | D12 | D11 | D10 | D9 | D8 | D7                            | D6 | D5 | D4 | D3 | D2 | D1  | D0 |
| Register Address [6:0] |     |     |     |     |     |    | 1  | Data (Issue by 3-Wire engine) |    |    |    |    |    |     |    |

8. Video Interface

8.1 LVDS interface

8.1.1 Data input format for LVDS

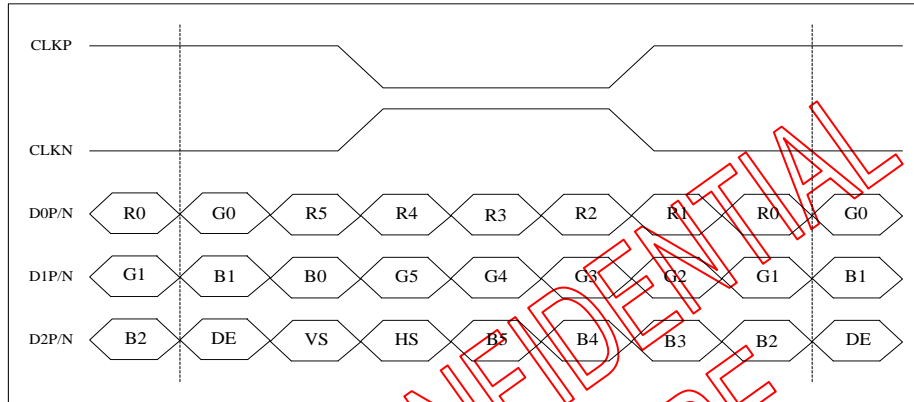

6-bit LVDS input (LVBIT=L, LVFMT=Don't care)

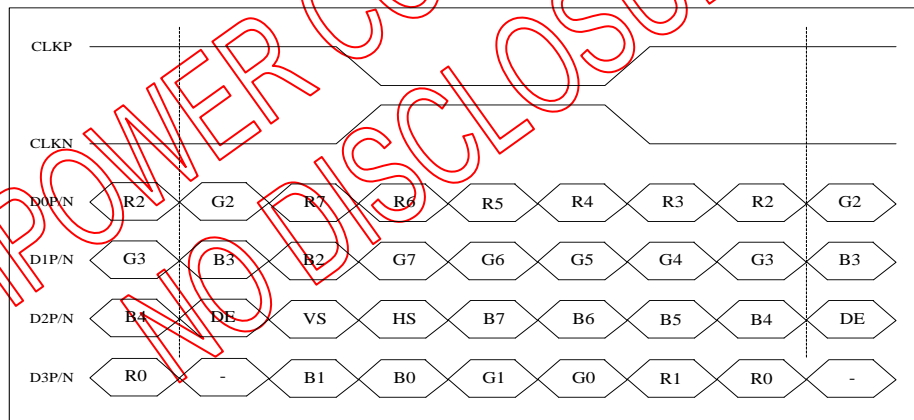

8-bit LVDS input (LVBIT=H, LVFMT=L)

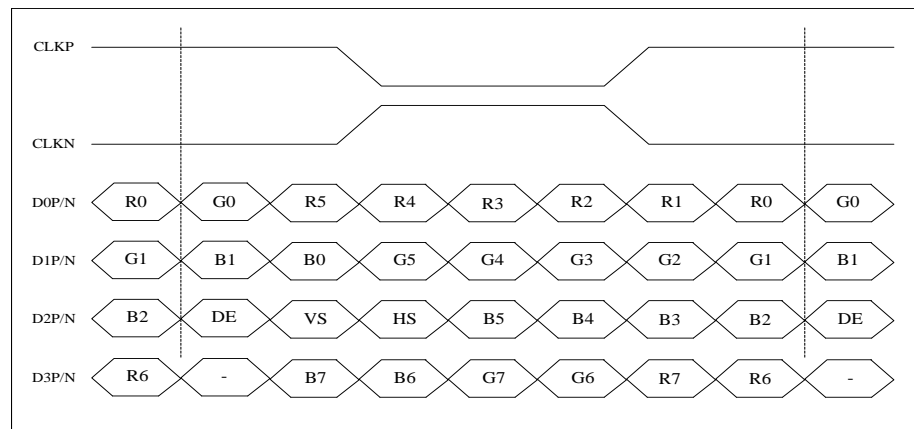

8-bit LVDS input(LVBIT=H, LVFMT=H)

## 9. Timing Table

### 9.1 Input Timing Table

For 1366RGBx768 HV mode

| Parameter                              | Symbol            | Value |      |      | Unit |
|----------------------------------------|-------------------|-------|------|------|------|
|                                        |                   | Min.  | Typ. | Max. |      |
| DCLK frequency @Frame rate=60Hz (LVDS) | F <sub>DCLK</sub> | 69.7  | 75   | 80.9 | MHz  |
| HSYNC period time                      | T <sub>H</sub>    | 1468  | 1550 | 1596 | DCLK |
| Horizontal display area                | T <sub>HD</sub>   | 1366  |      |      | DCLK |
| HSYNC pulse width                      | T <sub>HPW</sub>  | Min.  | 2    |      |      |
|                                        |                   | Typ.  | -    |      |      |
|                                        |                   | Max.  | 40   |      |      |
| HSYNC back porch(with pulse width)     | T <sub>HBP</sub>  | 88    | 88   | 88   | DCLK |
| HSYNC front porch                      | T <sub>HFP</sub>  | 14    | 96   | 142  | DCLK |
| VSYNC period time                      | T <sub>V</sub>    | 792   | 806  | 840  | H    |
| Vertical display area                  | T <sub>VD</sub>   | 768   |      |      | H    |
| VSYNC pulse width                      | T <sub>VPW</sub>  | Min.  | 2    |      | H    |
|                                        |                   | Typ.  | -    |      |      |
|                                        |                   | Max.  | 20   |      |      |
| VSYNC back porch(with pulse width)     | T <sub>VBP</sub>  | 23    | 23   | 23   | H    |
| VSYNC front porch                      | T <sub>VFP</sub>  | 1     | 15   | 49   | H    |

For 1366RGBx768 DE mode

| Parameter                              | Symbol                              | Value |      |      | Unit |
|----------------------------------------|-------------------------------------|-------|------|------|------|
|                                        |                                     | Min.  | Typ. | Max. |      |
| DCLK frequency @Frame rate=60Hz (LVDS) | F <sub>DCLK</sub>                   | 69.7  | 75   | 80.9 | MHz  |
| Horizontal display area                | T <sub>HD</sub>                     | 1366  |      |      | DCLK |
| HSYNC period time                      | T <sub>H</sub>                      | 1468  | 1550 | 1596 | DCLK |
| HSYNC blanking                         | T <sub>HBP</sub> +T <sub>HFP</sub>  | 102   | 184  | 230  | DCLK |
| Vertical display area                  | T <sub>VD</sub>                     | 768   |      |      | H    |
| VSYNC period time                      | T <sub>V</sub>                      | 792   | 806  | 840  | H    |
| VSYNC blanking                         | T <sub>VBP</sub> + T <sub>VFP</sub> | 24    | 38   | 72   | H    |

For 1280RGBx800

| Parameter                              | Symbol            | Value |      |      | Unit |
|----------------------------------------|-------------------|-------|------|------|------|
|                                        |                   | Min.  | Typ. | Max. |      |
| DCLK frequency @Frame rate=60Hz (LVDS) | F <sub>DCLK</sub> | 68.2  | 72.4 | 78.5 | MHz  |
| HSYNC period time                      | T <sub>H</sub>    | 1380  | 1440 | 1500 | DCLK |
| Horizontal display area                | T <sub>HD</sub>   | 1280  |      |      | DCLK |
| HSYNC pulse width                      | T <sub>HPW</sub>  | Min.  | 2    |      |      |
|                                        |                   | Typ.  | -    |      |      |
|                                        |                   | Max.  | 40   |      |      |
| HSYNC back porch(with pulse width)     | T <sub>HBP</sub>  | 88    | 88   | 88   | DCLK |
| HSYNC front porch                      | T <sub>HFP</sub>  | 12    | 72   | 132  | DCLK |
| VSYNC period time                      | T <sub>V</sub>    | 824   | 838  | 872  | H    |
| Vertical display area                  | T <sub>VD</sub>   | 800   |      |      | H    |
| VSYNC pulse width                      | T <sub>VPW</sub>  | Min.  | 2    |      | H    |
|                                        |                   | Typ.  | -    |      |      |
|                                        |                   | Max.  | 20   |      |      |
| VSYNC back porch(with pulse width)     | T <sub>VBP</sub>  | 23    | 23   | 23   | H    |
| VSYNC front porch                      | T <sub>VFP</sub>  | 1     | 15   | 49   | H    |

For 1280RGBx800 DE mode

| Parameter                              | Symbol                             | Value |      |      | Unit |
|----------------------------------------|------------------------------------|-------|------|------|------|
|                                        |                                    | Min.  | Typ. | Max. |      |
| DCLK frequency @Frame rate=60Hz (LVDS) | F <sub>DCLK</sub>                  | 68.2  | 72.4 | 78.5 | MHz  |
| Horizontal display area                | T <sub>HD</sub>                    | 1280  |      |      | DCLK |
| HSYNC period time                      | T <sub>H</sub>                     | 1380  | 1440 | 1500 | DCLK |
| HSYNC blanking                         | T <sub>HBP</sub> +T <sub>HFP</sub> | 100   | 160  | 220  | DCLK |
| Vertical display area                  | T <sub>VD</sub>                    | 800   |      |      | H    |
| VSYNC period time                      | T <sub>V</sub>                     | 824   | 838  | 872  | H    |
| VSYNC blanking                         | T <sub>VBP</sub> +T <sub>VFP</sub> | 24    | 38   | 72   | H    |

**Note:Timing setting base on 60Hz,  
Frequency can be adjusted according to needs, as long as it does not affect the display.**

For 1280RGBx720

| Parameter                              | Symbol            | Value |      |      | Unit |
|----------------------------------------|-------------------|-------|------|------|------|
|                                        |                   | Min.  | Typ. | Max. |      |
| DCLK frequency @Frame rate=60Hz (LVDS) | F <sub>DCLK</sub> | 61.6  | 65.5 | 71.3 | MHz  |
| HSYNC period time                      | T <sub>H</sub>    | 1380  | 1440 | 1500 | DCLK |
| Horizontal display area                | T <sub>HD</sub>   | 1280  |      |      | DCLK |
| HSYNC pulse width                      | T <sub>HPW</sub>  | Min.  | 2    |      |      |
|                                        |                   | Typ.  | -    |      |      |
|                                        |                   | Max.  | 40   |      |      |
| HSYNC back porch(with pulse width)     | T <sub>HBP</sub>  | 88    | 88   | 88   | DCLK |
| HSYNC front porch                      | T <sub>HFP</sub>  | 12    | 72   | 132  | DCLK |
| VSYNC period time                      | T <sub>V</sub>    | 744   | 758  | 792  | H    |
| Vertical display area                  | T <sub>VD</sub>   | 720   |      |      | H    |
| VSYNC pulse width                      | T <sub>VPW</sub>  | Min.  | 2    |      | H    |
|                                        |                   | Typ.  | -    |      |      |
|                                        |                   | Max.  | 20   |      |      |
| VSYNC back porch(with pulse width)     | T <sub>VBP</sub>  | 23    | 23   | 23   | H    |
| VSYNC front porch                      | T <sub>VFP</sub>  | 1     | 15   | 49   | H    |

For 1024RGBx768

| Parameter                       | Symbol                             | Value |      |      | Unit |
|---------------------------------|------------------------------------|-------|------|------|------|
|                                 |                                    | Min.  | Typ. | Max. |      |
| DCLK frequency @Frame rate=60hz | F <sub>DCLK</sub>                  | 52    | 65   | 71   | Mhz  |
| Horizontal display area         | T <sub>HD</sub>                    | 1024  |      |      | DCLK |
| HSYNC period time               | T <sub>H</sub>                     | 1114  | 1344 | 1400 | DCLK |
| HSYNC blanking                  | T <sub>HBP</sub> +T <sub>HFP</sub> | 90    | 320  | 376  | DCLK |
| Vertical display area           | T <sub>VD</sub>                    | 768   |      |      | H    |
| VSYNC period time               | T <sub>V</sub>                     | 778   | 806  | 845  | H    |
| VSYNC blanking                  | T <sub>VBP</sub> +T <sub>VFP</sub> | 10    | 38   | 77   | H    |

**Note : Blanking setting must be even numbers.**



Vertical timing

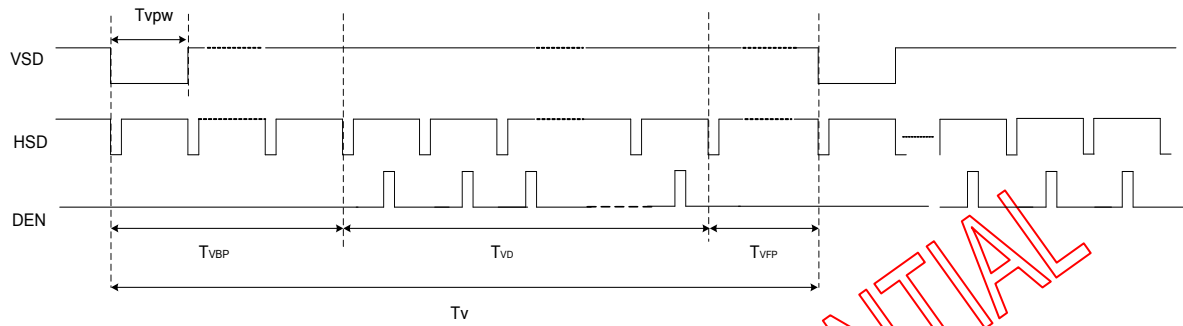

Horizontal timing

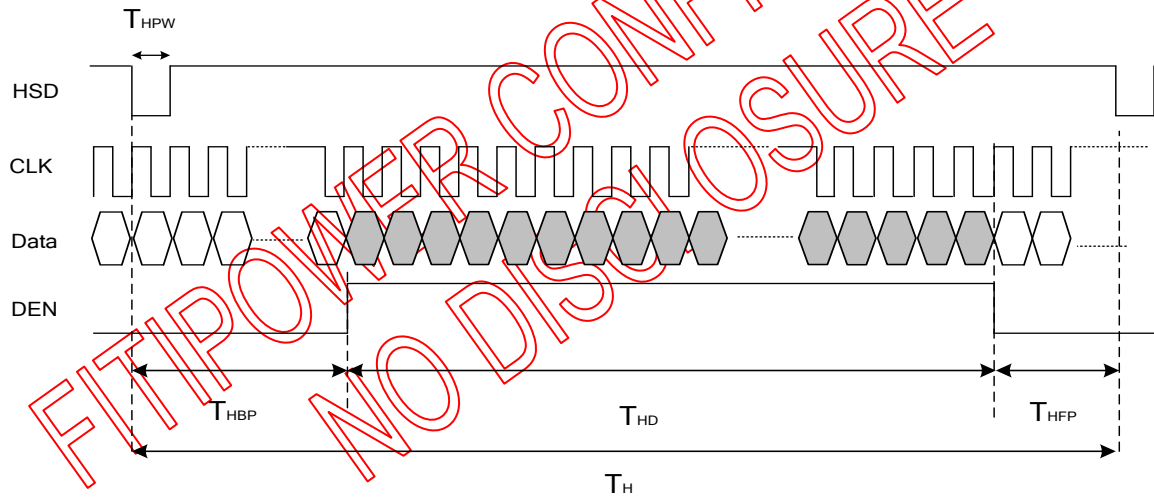

9.2 Gate Output Timing Table

(VDD=2.3 to 3.6V, VSS=VSSA=VSS\_IF=0V, TA=-30 to +85°C)

| Parameter            | Symbol              | Min. | Typ. | Max. | Unit |
|----------------------|---------------------|------|------|------|------|
| STV Pulse Width      | T <sub>WSTV</sub>   | -    | 1    | -    | H    |
| Time from HSD to STV | T <sub>HSTV</sub>   | -    | 2    | -    | DCLK |
| Time from HSD to CKV | T <sub>HCKV</sub>   | -    | 25   | -    | DCLK |
| Time from HSD to OEV | T <sub>HOEV</sub>   | -    | 35   | -    | DCLK |
| Time from CKV to OEV | T <sub>CKV_OE</sub> | -    | 168  | -    | DCLK |
| OEV Pulse Width      | T <sub>WOEV</sub>   | -    | 188  | -    | DCLK |

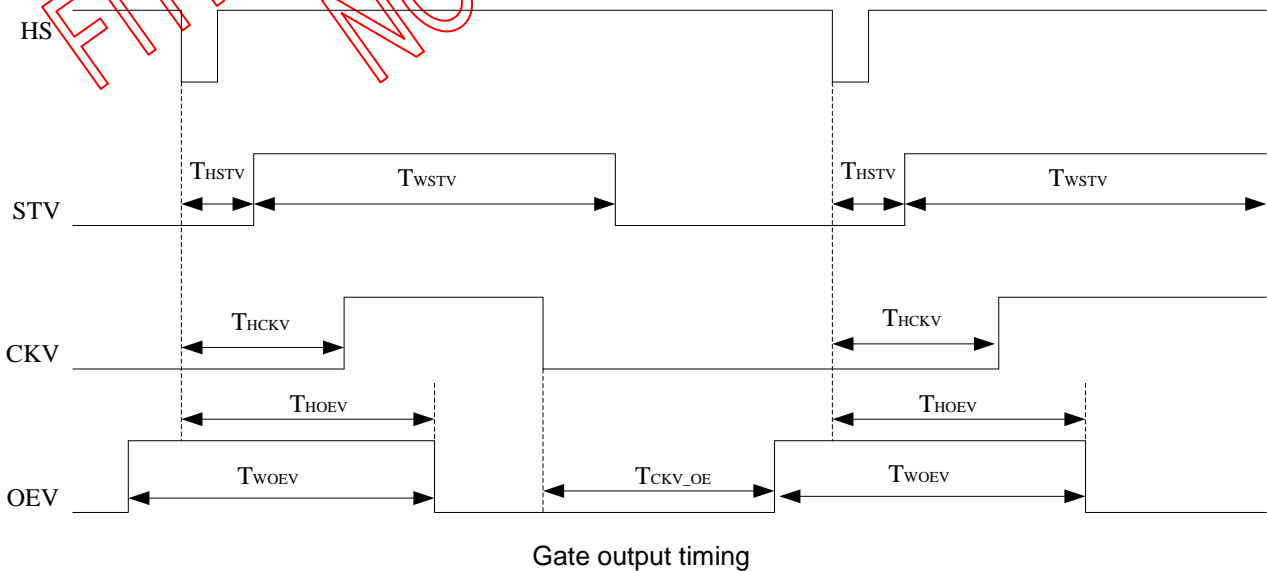
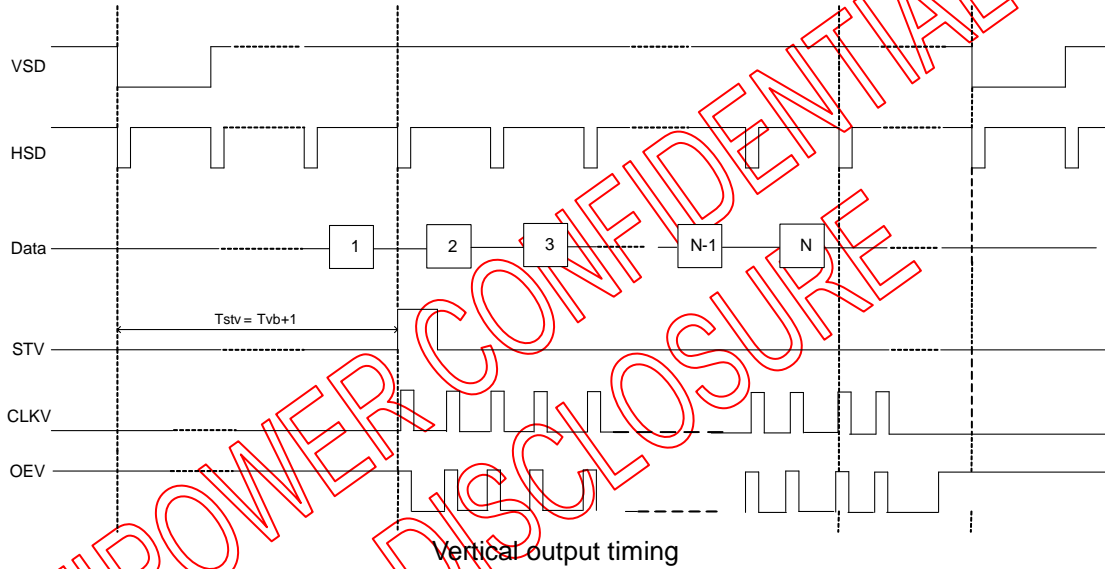

10. Power Sequence and External Power Circuit

10.1 Power Generation

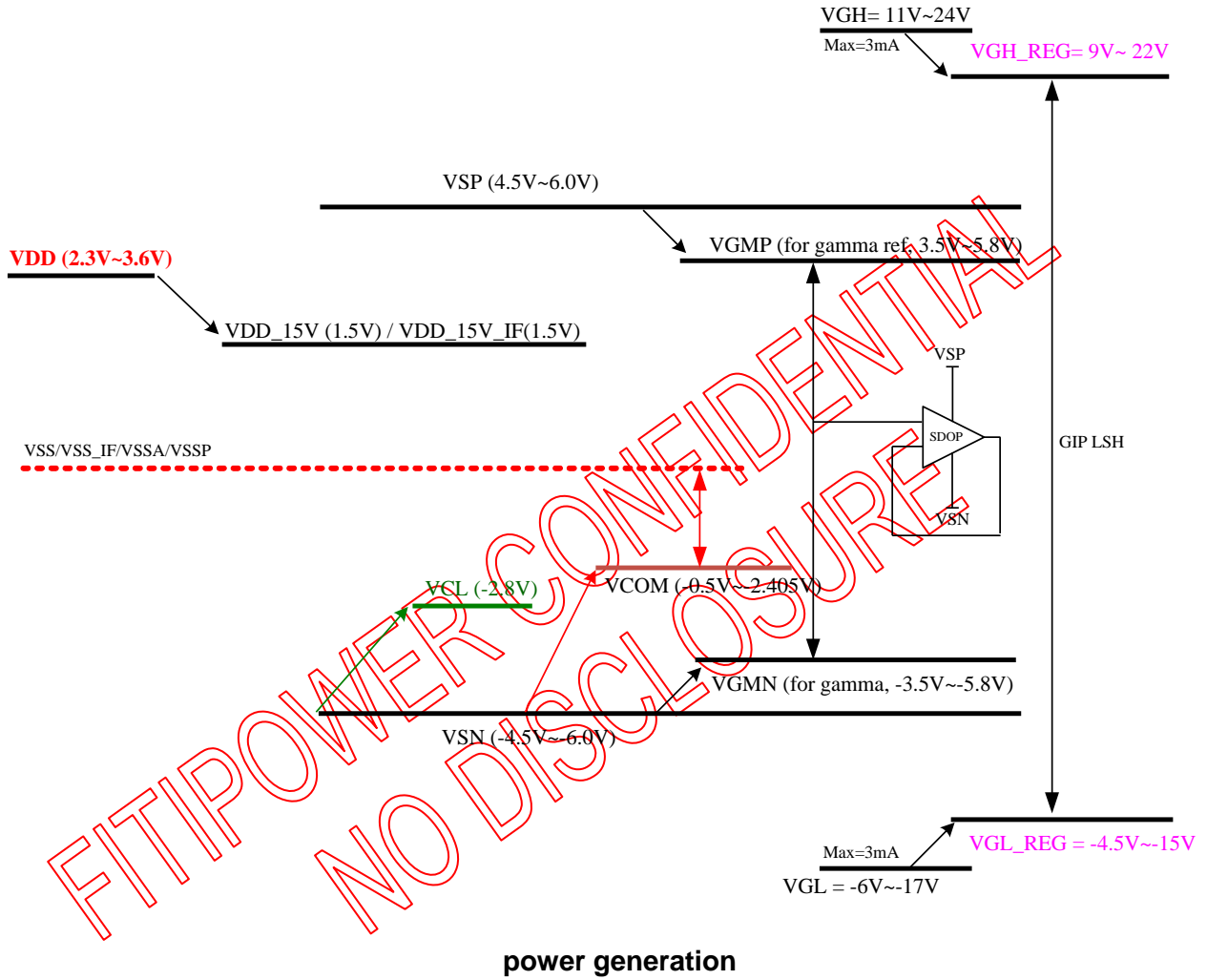

10.2 Power on sequence

10.2.1 Power on sequence

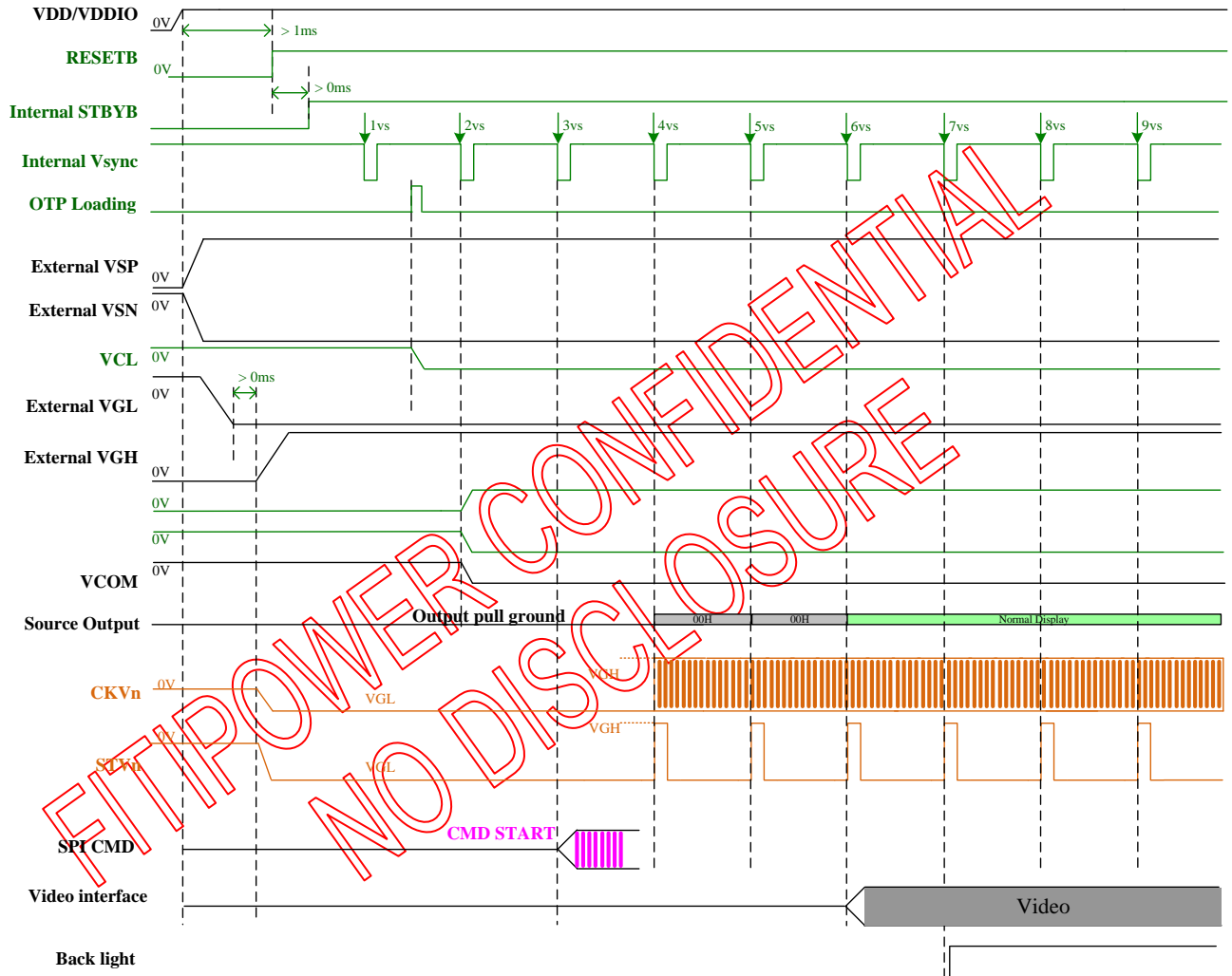

Note: Before Power on process is have to check all power input of external that is Gnd.

10.2.2 Power off sequence

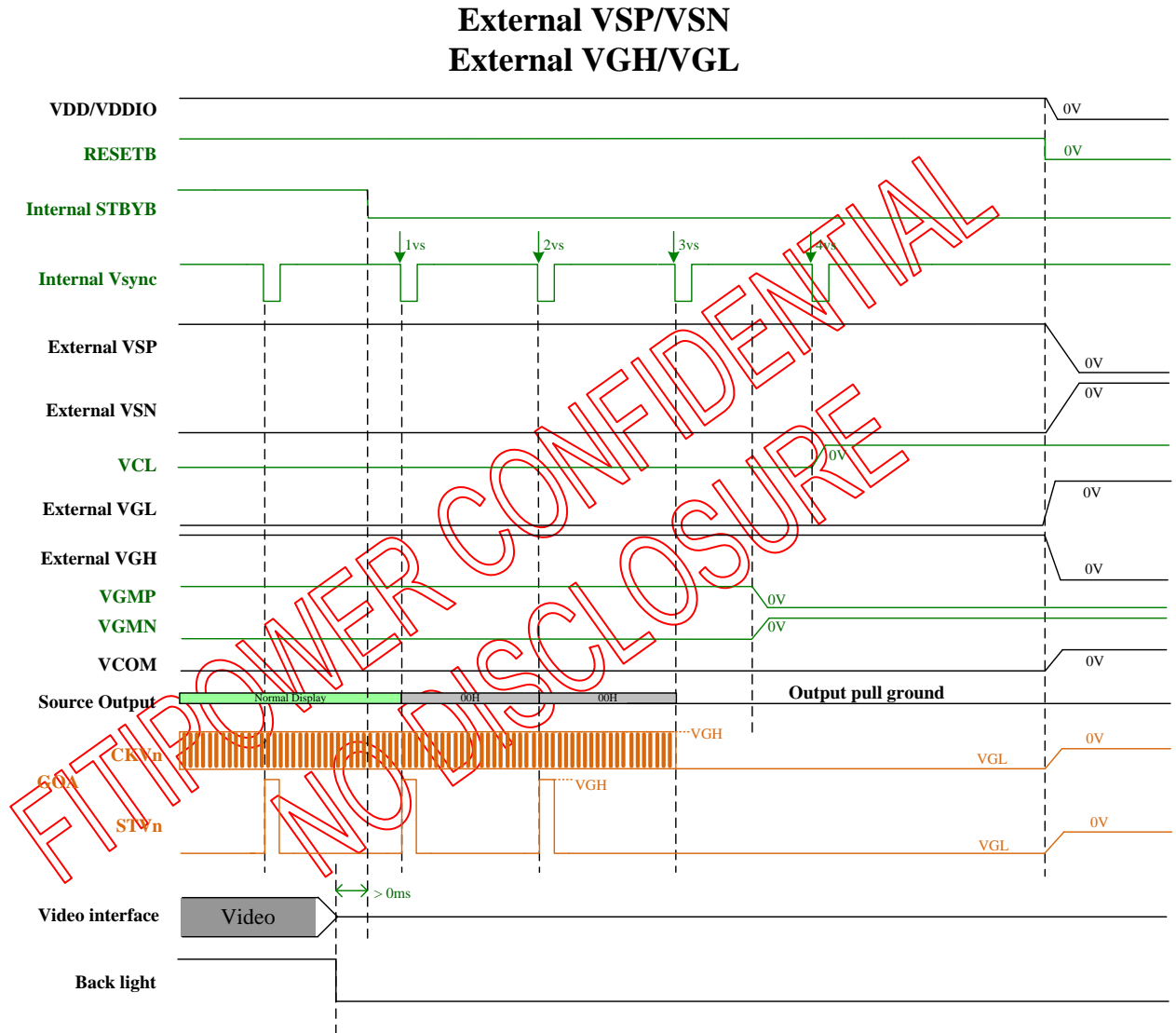

**10.3 Application power circuit**

VDD=VDDIO=VDD\_IF=2.3~3.6V, VSP=4.5~6.0V, VSN=-4.5~-6.0V.

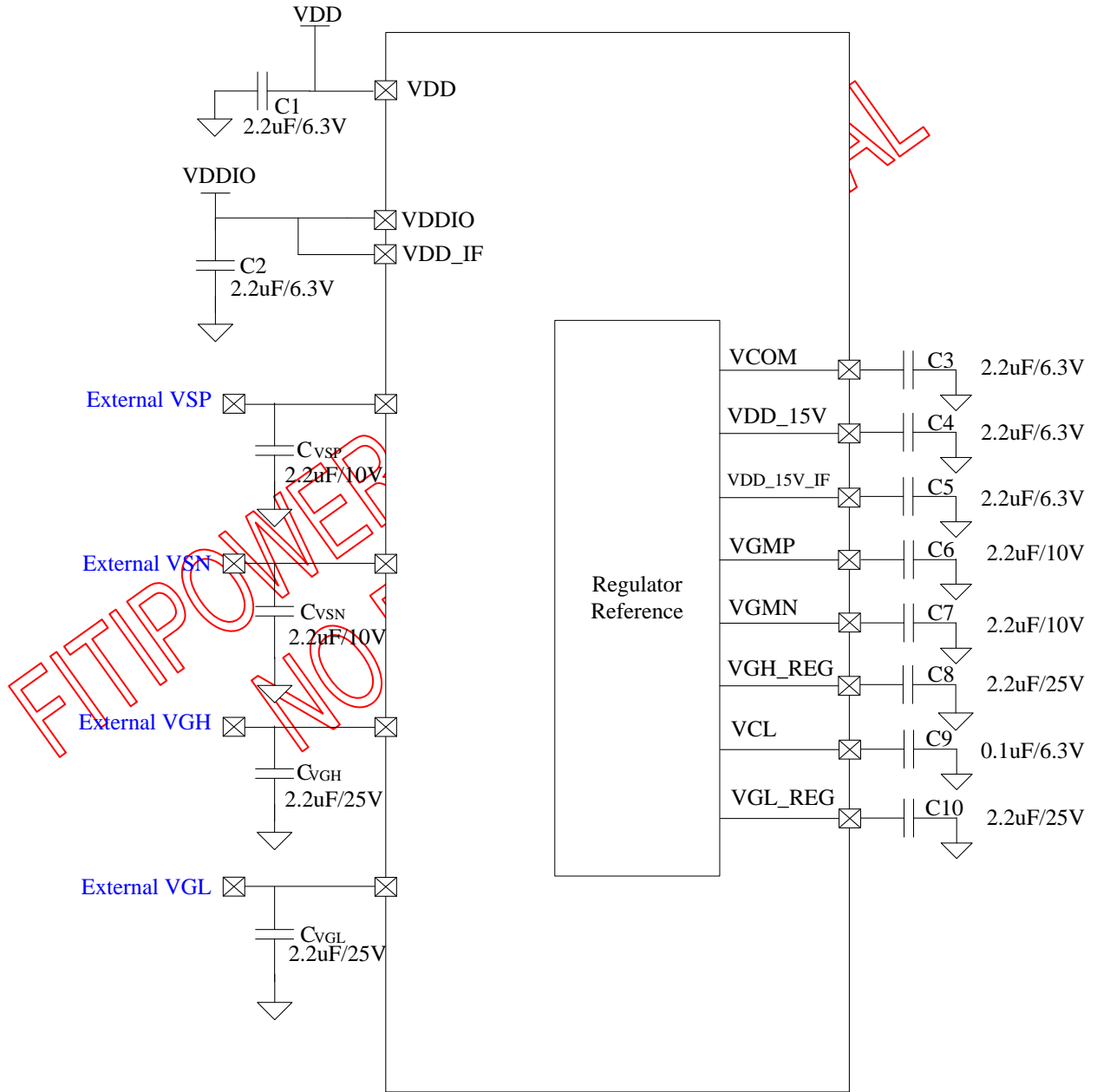

**11. Function Description**

**11.1 BIST pattern**

We support the BIST mode to test panel and debug. It can stop pattern at any time while BISTB set to low. The pattern sequence is listed below.

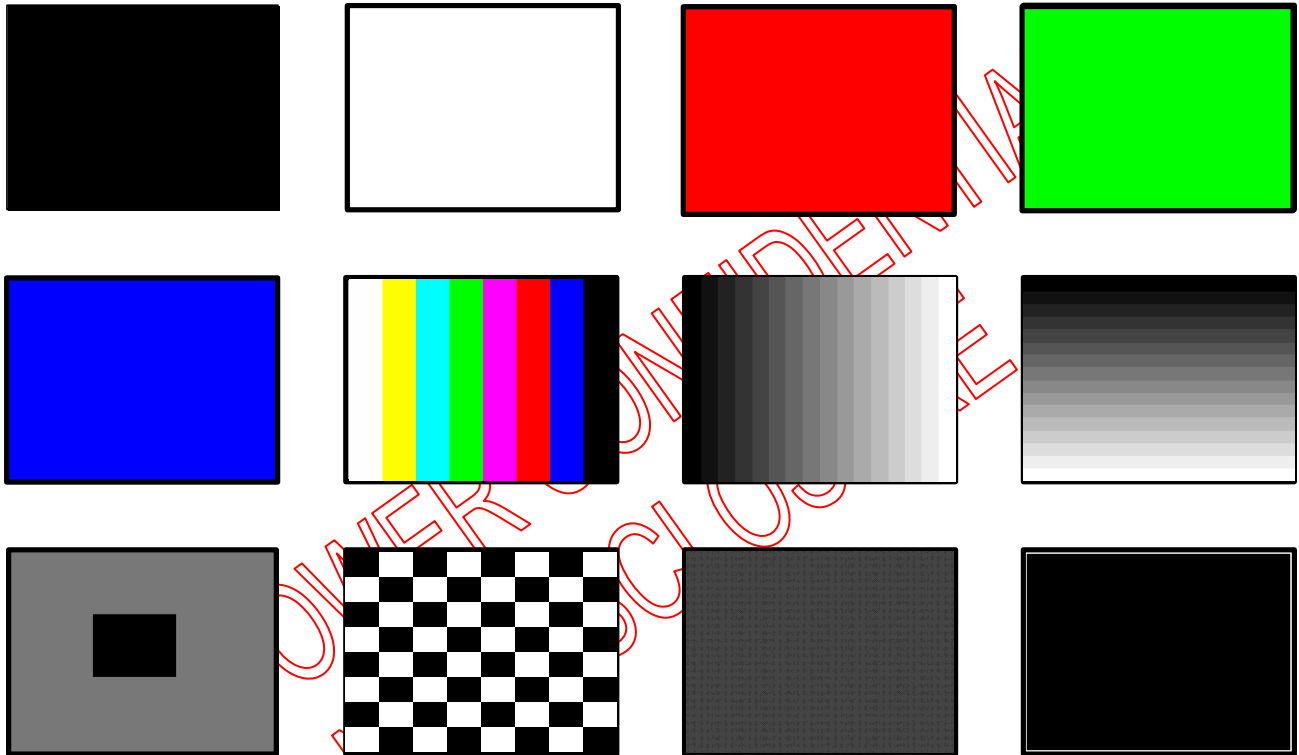

Black→White→R→G→B→Color Bar→Horizontal 256 gray scale→Vertical 256 gray scale→Crosstalk pattern→Chess board (L255/L0)→Flicker pattern→Black background with white out frame

12. Gamma Correction Resistances

We use the gamma resistor stream and 64-to-1 selector to adjust voltage

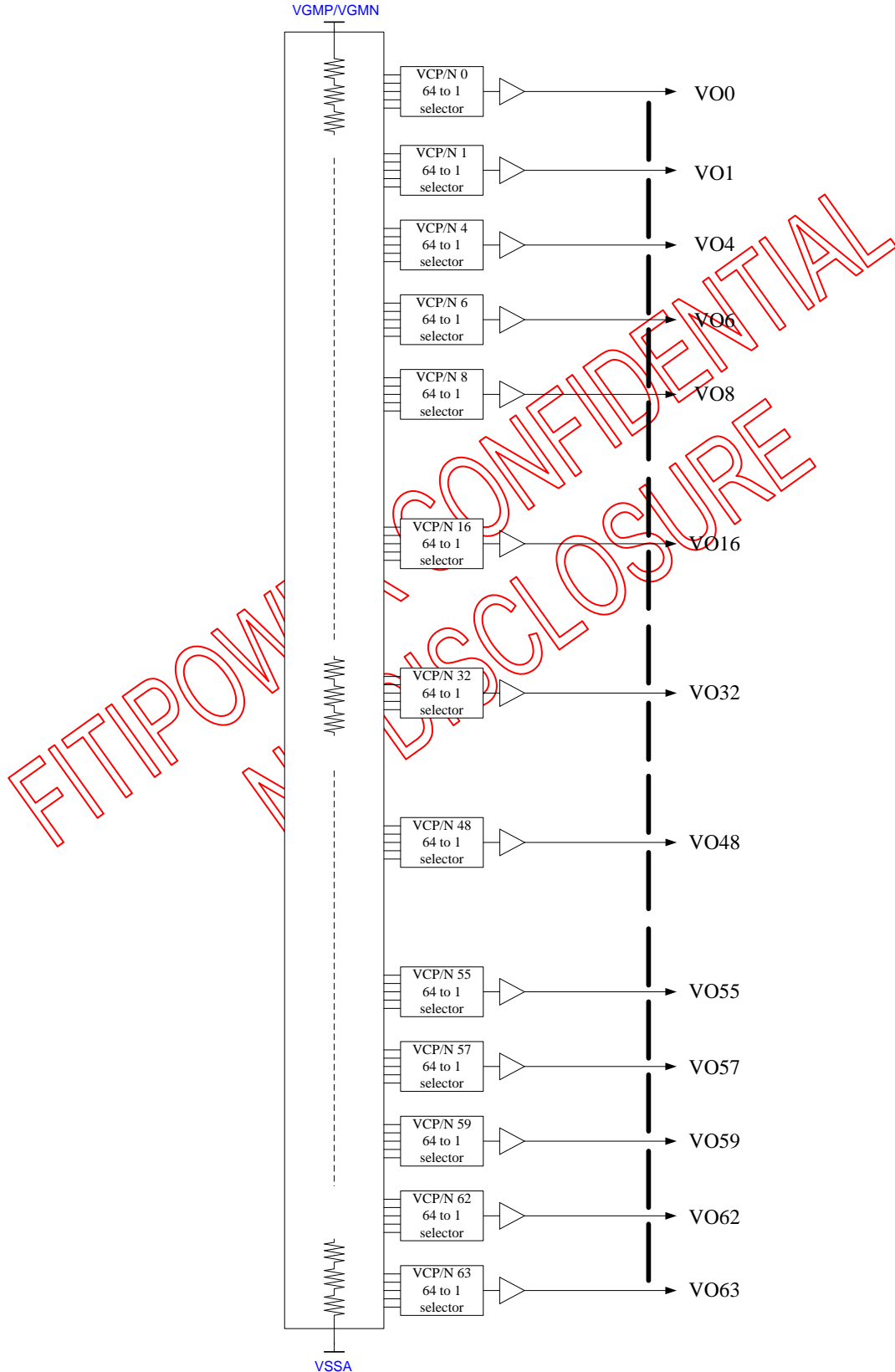



12.1 Relationship between input data and output voltage

The output voltage is determined by the 6-bit digital input data, POL and the 26 gamma corrected reference voltages. Among these gamma corrected reference voltages, VGMA1 ~VGMA13 and VGMA14 ~VGMA26 are for positive polarity voltage output and negative polarity voltage output respectively.

| POL | OUT <sub>2n-1</sub> | OUT <sub>2n</sub> |
|-----|---------------------|-------------------|
| H   | VGMA14~VGMA26       | VGMA1~VGMA13      |
| L   | VGMA1~VGMA13        | VGMA14~VGMA26     |

GAMMA Corrected Characteristic Curve

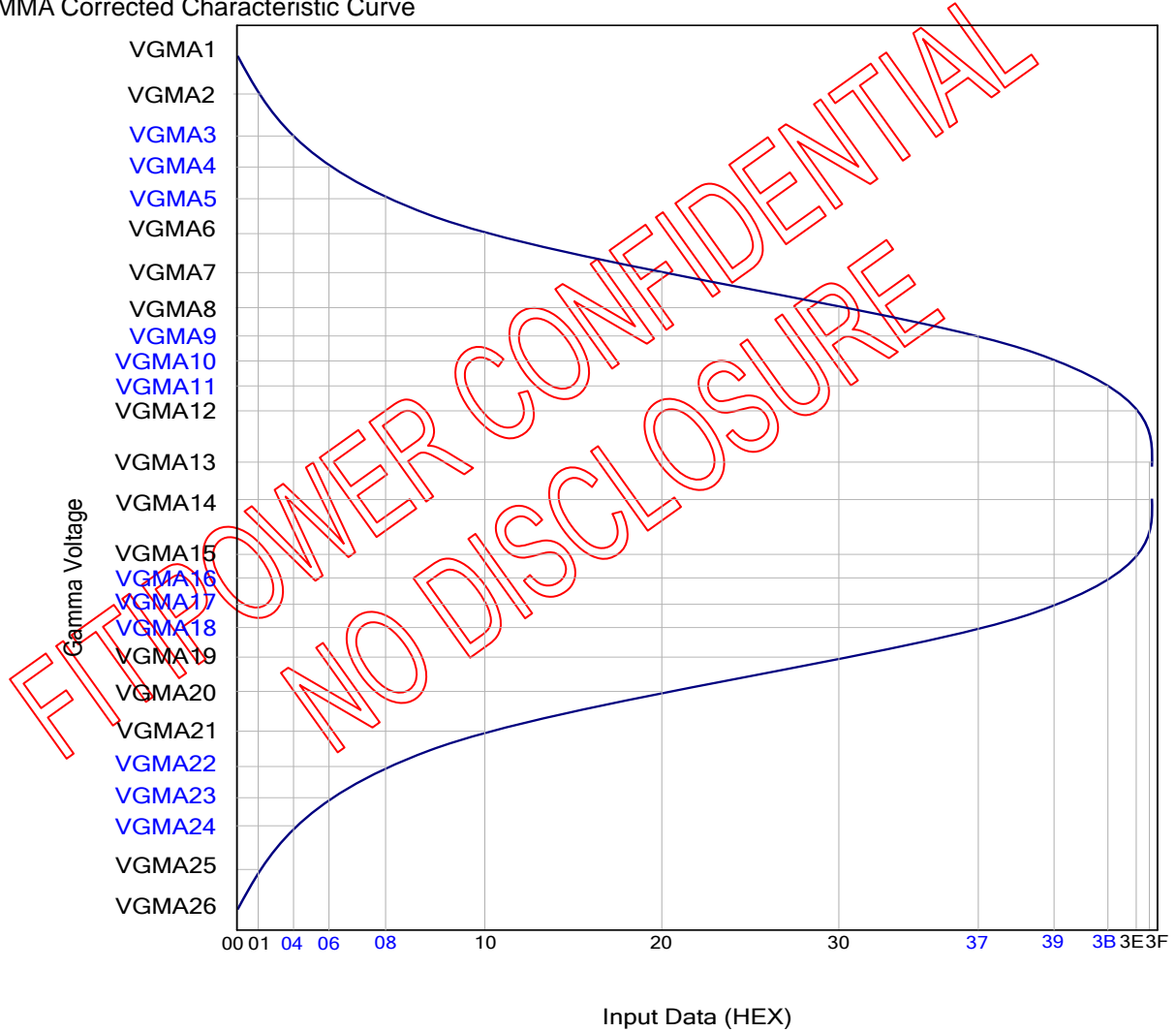

**Note:**

VSP ≥ VGMP+0.2

VSN ≤ VGMN-0.2

VGMA13-0.2V ≥ GND ≥ VGMA14+0.2V

## 13. DC Characteristics

### 13.1 Absolute maximum ratings

| Parameter              | Symbol | Spec. |      |            | Unit | Note |
|------------------------|--------|-------|------|------------|------|------|
|                        |        | Min.  | Typ. | Max.       |      |      |
| I/O voltage            | VDDIO  | -0.5  | -    | 4          | V    | -    |
| Interface supply power | VDD_IF | -0.5  | -    | 4          |      |      |
| Power input            | VDD    | -0.5  | -    | 4          | V    | -    |
| VSP supply power       | VSP    | -0.5  | -    | 6.6        | V    | -    |
| VSN supply power       | VSN    | -6.6  | -    | 0.3        | V    | -    |
| VGH supply power       | VGH    | -0.5  | -    | VGL_GIP+32 | V    | -    |
| VGL supply power       | VGL    | -17   | -    | 0.3        | V    | -    |
| Operating temperature  | Top    | -30   | -    | 85         | °C   | (1)  |
| Storage temperature    | Tstg   | -55   | -    | 125        | °C   | -    |

Note : 1) Do not let condensation for low temperature

**Table 10.1: Absolute maximum rating**

### 13.2 Typical operating condition

| Parameter       | Symbol  | Spec. |      |      | Unit | Note                     |
|-----------------|---------|-------|------|------|------|--------------------------|
|                 |         | Min.  | Typ. | Max. |      |                          |
| VDD voltage     | VDD     | -     | 3.3  | -    | V    | Analog supply voltage    |
| VDDIO voltage   | VDDIO   | -     | 3.3  | -    | V    | I/O Power supply voltage |
| VSP voltage     | VSP     | 4.5   | 5.0  | 6    | V    | VSP voltage              |
| VSN voltage     | VSN     | -6    | -5.0 | -4.5 | V    | VSN voltage              |
| VGH voltage     | VGH     | 11    | 18   | 24   | V    | VGH voltage              |
| VGL voltage     | VGL     | -17   | -12  | -6   | V    | VGL_ voltage             |
| VGL_REG voltage | VGL_REG | -15   | -10  | -4.5 | V    | VGL_REG voltage          |

**Table 10.2: Typical operating conditions**

### 13.3 DC electrical characteristics

(Test condition: VDD=VDDIO=VDDIF=2.3~3.6V, TA=-30°C~+85°C, VSS=VSSA=0V)

| Parameter                      | Symbol                                     | Spec.       |       |             | Unit | Note |
|--------------------------------|--------------------------------------------|-------------|-------|-------------|------|------|
|                                |                                            | Min.        | Typ.  | Max.        |      |      |
| Input high level voltage       | VIH                                        | 0.8 x VDDIO |       | VDDIO       | V    |      |
| Input low level voltage        | VIL                                        | VSS         |       | 0.2 x VDDIO | V    |      |
| Input Leakage Current          | Ileak                                      | (-1)        |       | (+1)        | μA   |      |
| Output high level voltage      | VOH                                        | 0.8 x VDDIO |       | VDDIO       | V    |      |
| Output low level voltage       | VOL                                        | VSS         |       | 0.2 x VDDIO | V    |      |
| VGH_REG output voltage         | VGH_REG                                    | 9           | 16    | 22          | V    |      |
| VGL_REG output voltage         | VGL_REG                                    | -15         | -10   | -4.5        |      |      |
| VGMP output voltage            | VGMP                                       | 3.5         | 4.24  | 5.8         | V    |      |
| VGMIN output voltage           | VGMIN                                      | -5.8        | -4.64 | -3.5        | V    |      |
| VGL output voltage             | VGL                                        | -17         | -12   | -6          | V    |      |
| VGH output voltage             | VGH                                        | 11          | 18    | 24          | V    |      |
| VCL output voltage             | VCL                                        | -3          | -2.8  | -2.1        | V    |      |
| VCOM output voltage            | VCOM                                       | -2.405      | -1.5  | -0.5        | V    |      |
| Input terminal resistance      | ZID                                        |             | 100   |             | ohm  |      |
| Source output level deviation  | Graycode = 0 ~ 14<br>Graycode = 241 ~ 255  |             | TBD   |             | mV   |      |
|                                | Graycode = 15 ~ 31<br>Graycode = 208 ~ 240 |             | TBD   |             | mV   |      |
|                                | Graycode = 32 ~ 207                        |             | TBD   |             | mV   |      |
| Source output offset deviation | Graycode = 0 ~ 14<br>Graycode = 241 ~ 255  | -           | TBD   |             | mV   |      |
|                                | Graycode = 15 ~ 31<br>Graycode = 208 ~ 240 | -           | TBD   |             | mV   |      |
|                                | Graycode = 32 ~ 207                        | -           | TBD   |             | mV   |      |
| Current consumption            | Analog Operating                           | IAOP        |       | TBD         | mA   |      |
|                                | Analog Stand-by                            | IAST        |       | TBD         | mA   |      |
| Rush current                   | Ivddpeak                                   |             | TBD   |             | mA   |      |

## 13.4 LVDS DC electrical characteristics

(VDD=VDDIO=VDDIF=2.3 to 3.6V, VSS=VSSA=VSS\_IF=0V, TA=-30 to +85°C)

| Parameter                                 | Symbol       | Min. | Typ. | Max. | Unit | Condition                                                           |
|-------------------------------------------|--------------|------|------|------|------|---------------------------------------------------------------------|
| Differential input high threshold voltage | $R_{XVTH}$   | -    | -    | +0.1 | V    | $R_{XVCM}=1.2V$                                                     |
| Differential input low threshold voltage  | $R_{XVTL}$   | -0.1 | -    | -    | V    |                                                                     |
| Input voltage range (singled-end)         | $R_{XVIN}$   | 0.7  | -    | 1.7  | V    |                                                                     |
| Differential input common mode voltage    | $R_{XVCM}$   | 1    | 1.2  | 1.4  | V    | $ V_{ID} =0.2$                                                      |
| Differential input impedance              | $Z_{ID}$     | 80   | 100  | 125  | ohm  |                                                                     |
| Differential input voltage                | $ V_{ID} $   | 0.2  | -    | 0.6  | V    |                                                                     |
| Differential input leakage current        | $I_{LCLVDS}$ | -10  | -    | +10  | uA   |                                                                     |
| LVDS Digital Operating Current            | $I_{VDD}$    | -    | 15   | 20   | mA   | $F_{DCLK}=80MHz, VDD=3.3V,$<br>Input pattern:<br>55h->Aah->55h->Aah |
| LVDS Digital Stand-by Current             | $I_{ST}$     | -    | -    | 250  | uA   | Clock & all Functions are stopped                                   |

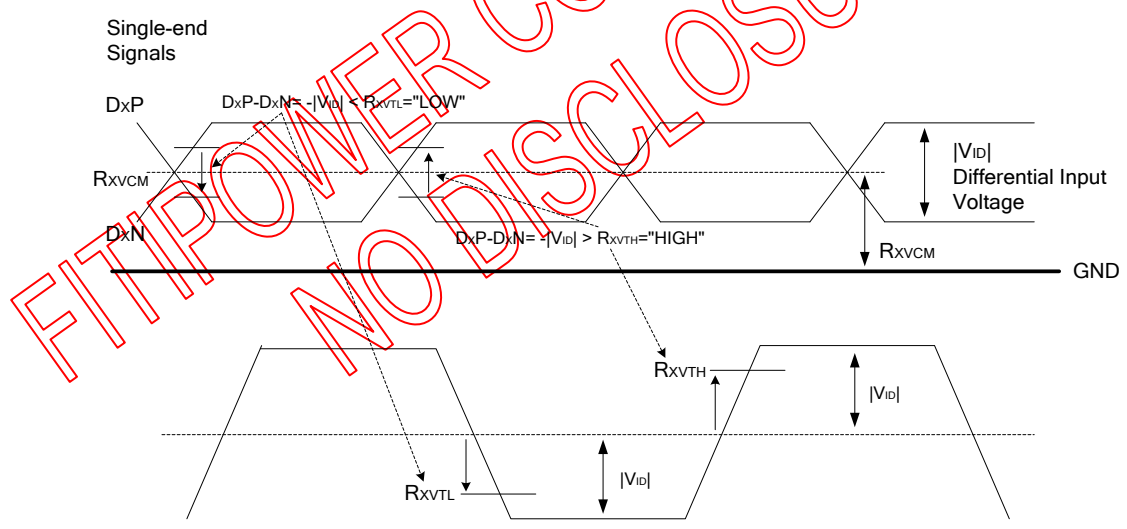

LVDS signal characteristics

| Parameter         | Symbol       | Min. | Typ. | Max. | Unit         |
|-------------------|--------------|------|------|------|--------------|
| Clock frequency   | $F_{LVDCYC}$ | 69.7 |      | 80.9 | MHz          |
| Clock period      | $T_{LVDCYC}$ |      |      | -    | ps           |
| 1 data bit time   | UI           | -    | 1/7  | -    | $T_{LVDCYC}$ |
| Clock high time   | $T_{LVCH}$   | 3.9  | 4    | 4.1  | UI           |
| Clock low time    | $T_{LVCL}$   | 2.9  | 3    | 3.1  | UI           |
| Position 1        | $T_{POS1}$   | -0.2 | 0    | 0.2  | UI           |
| Position 0        | $T_{POS0}$   | 0.8  | 1    | 1.2  | UI           |
| Position 6        | $T_{POS6}$   | 1.8  | 2    | 2.2  | UI           |
| Position 5        | $T_{POS5}$   | 2.8  | 3    | 3.2  | UI           |
| Position 4        | $T_{POS4}$   | 3.8  | 4    | 4.2  | UI           |
| Position 3        | $T_{POS3}$   | 4.8  | 5    | 5.2  | UI           |
| Position 2        | $T_{POS2}$   | 5.8  | 6    | 6.2  | UI           |
| Input eye width   | $T_{EYEW}$   | 0.6  |      | -    | UI           |
| Input eye border  | $T_{EX}$     |      |      | 0.2  | UI           |
| LVDS wake up time | $T_{ENLVDS}$ | -    |      | 150  | us           |

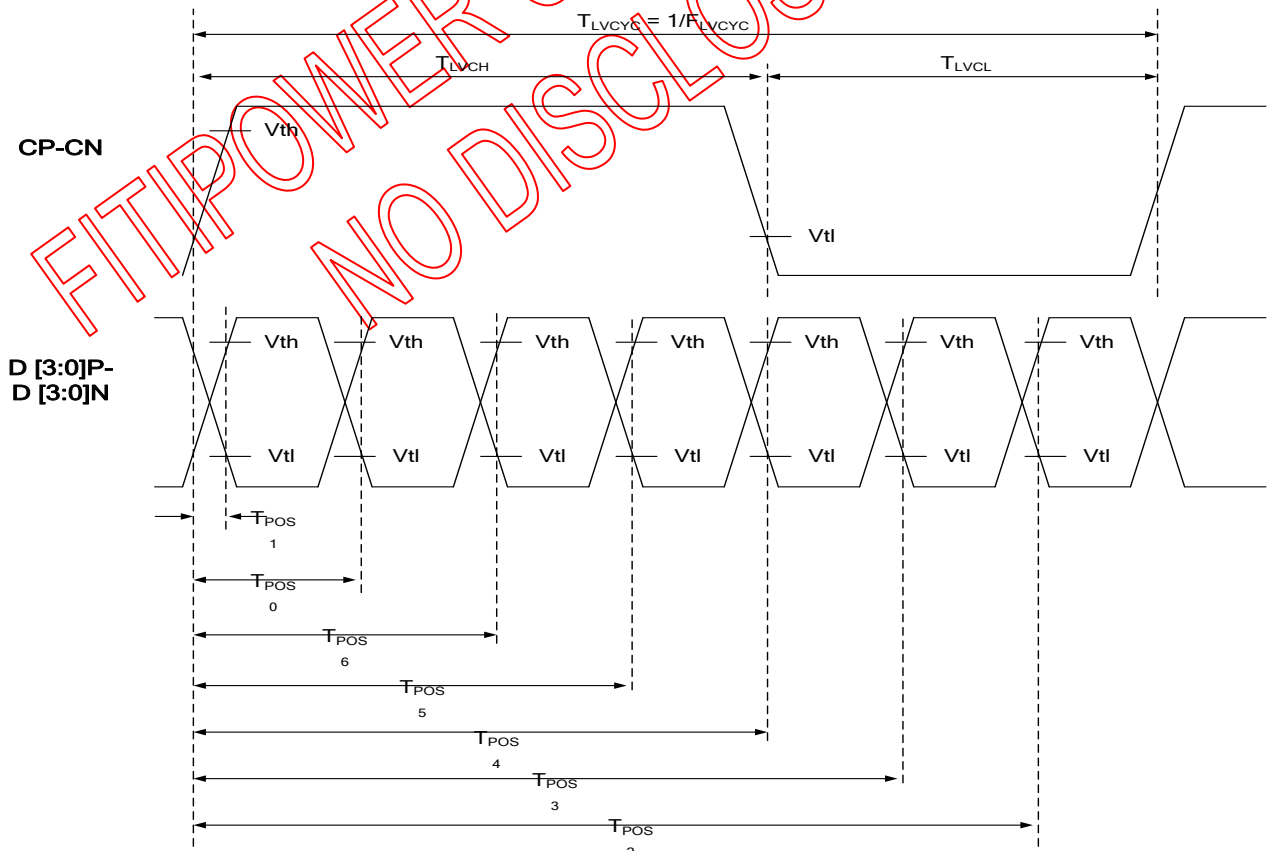

14. AC Characteristics

14.1 LVDS mode AC electrical characteristics

| Parameter              | Symbol              | Spec. |                            |      | Unit | Condition                                                                |
|------------------------|---------------------|-------|----------------------------|------|------|--------------------------------------------------------------------------|
|                        |                     | Min.  | Typ.                       | Max. |      |                                                                          |
| Clock frequency        | R <sub>x</sub> FCLK | 30    | -                          | TBD  | MHz  | Refer to input timing table for each display resolution                  |
| Input data skew margin | T <sub>RSKM</sub>   | 500   | -                          | -    | ps   | VID  = 200mV<br>R <sub>x</sub> VCM = 1.2V<br>R <sub>x</sub> FCLK = 81MHz |
| Clock high time        | T <sub>LVCH</sub>   | -     | 4/(7* R <sub>x</sub> FCLK) | -    | ns   |                                                                          |
| Clock low time         | T <sub>LVCL</sub>   | -     | 3/(7* R <sub>x</sub> FCLK) | -    | ns   |                                                                          |
| PLL wake-up time       | T <sub>enPLL</sub>  | -     | -                          | 150  | us   |                                                                          |

Table 13.1: LVDS mode AC electrical characteristics

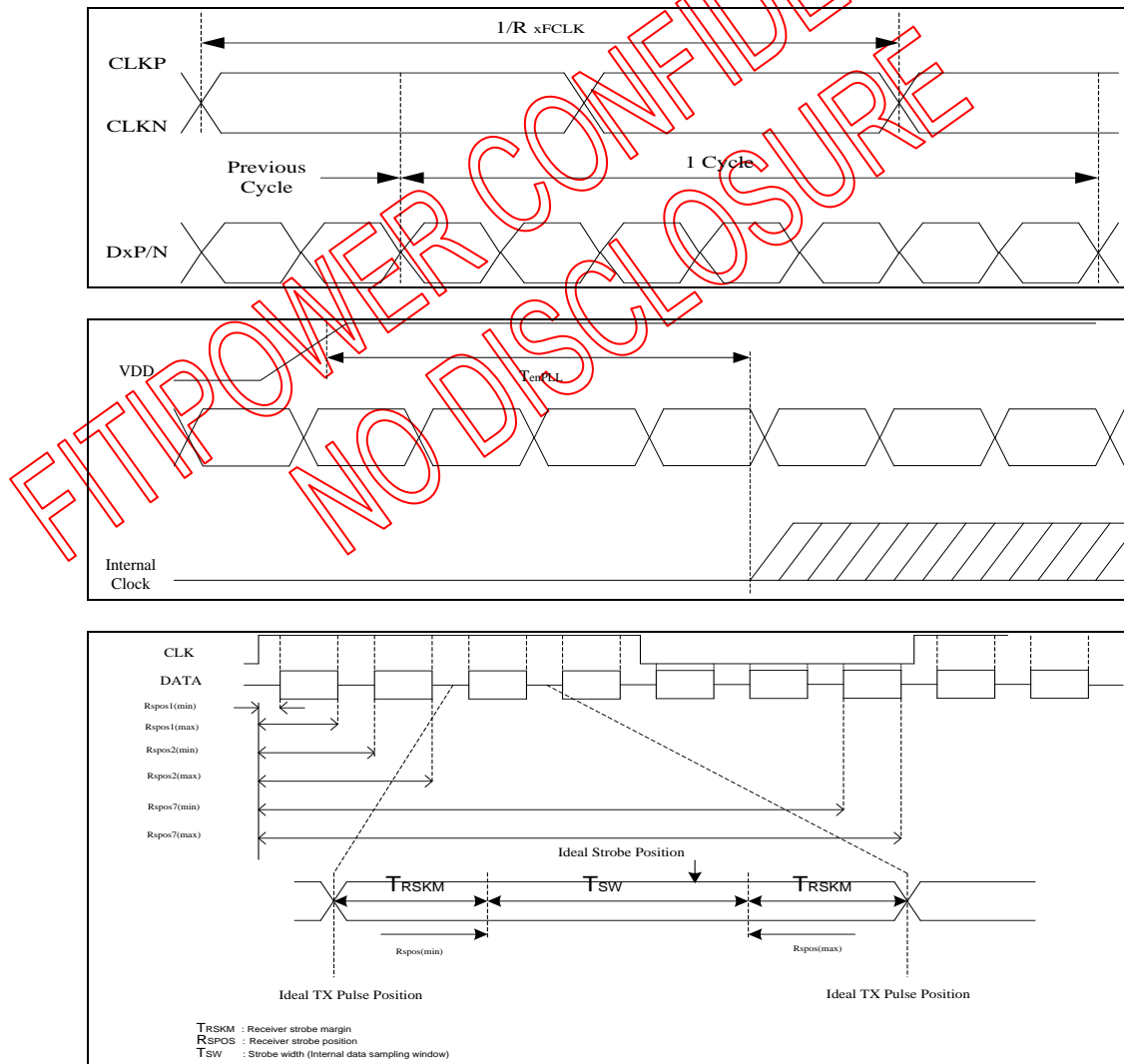
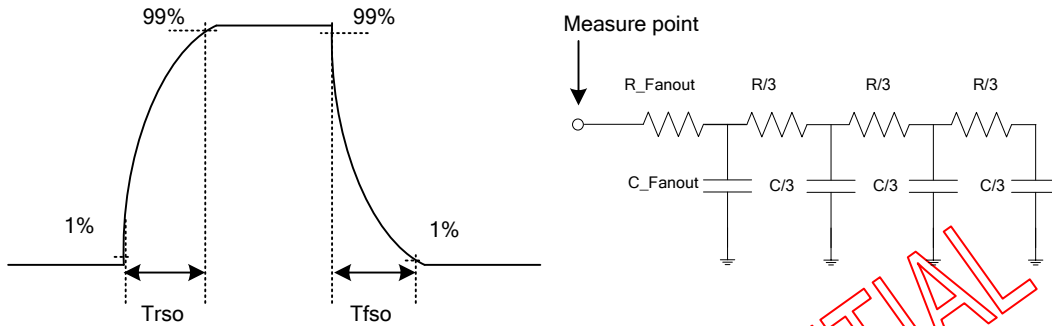

Figure 13.3: LVDS figure

14.2 Source output timing (SOUT0 ~ SOUT2051)



Rdata\_total = 25.072k(ohm)  
Cdata\_total = 83 pF

| Parameter                  | Symbol | Condition | Spec. |      |     | Unit |
|----------------------------|--------|-----------|-------|------|-----|------|
|                            |        |           | Min.  | Typ. | Max |      |
| Source driver rising time  | Trso   |           |       | 3.52 |     | μs   |
| Source driver falling time | Tfso   |           |       | 2.8  |     | μs   |

Table 13.2: Source output timing

Panel control signal output ( GOUTL[1]~GOUTL[22] , GOUTR[1]~GOUTR[22] )

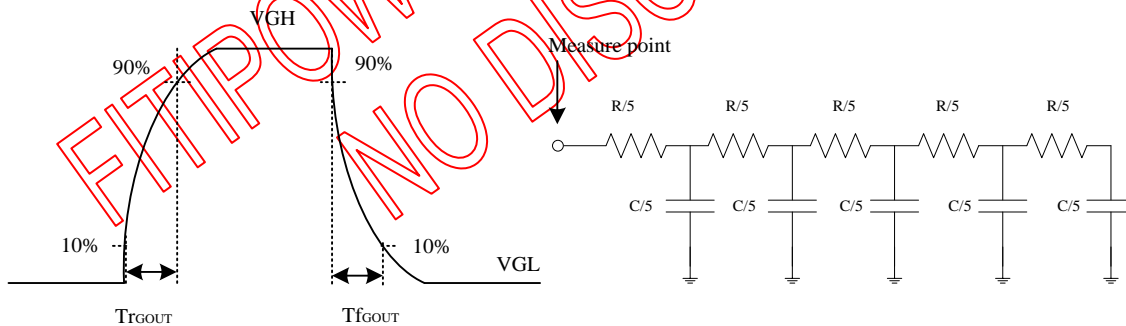

| Parameter                         | Symbol | Condition | Spec. |      |     | Unit |
|-----------------------------------|--------|-----------|-------|------|-----|------|
|                                   |        |           | Min.  | Typ. | Max |      |
| Panel control signal rising time  | TrGOUT | TBD       | -     | -    | TBD | μs   |
| Panel control signal falling time | TfGOUT | TBD       | -     | -    | TBD | μs   |

Table 13.3: GOA output timing

14.3 Serial interface characteristics

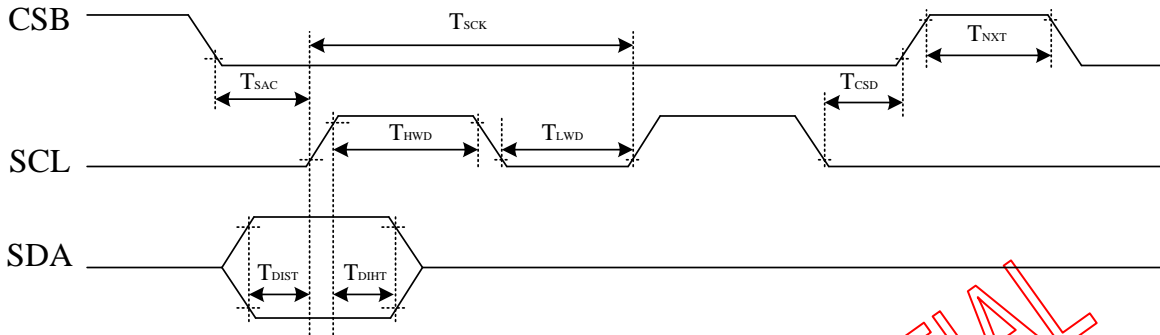
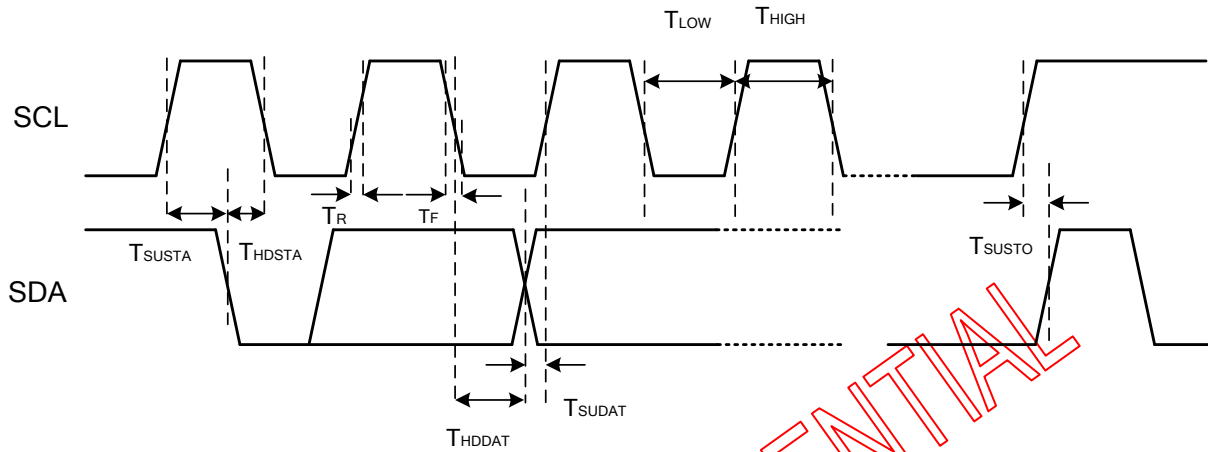

Figure 13.4: Serial interface characteristics

| Parameter                             | Symbol     | Conditions | Spec. |      |     | Unit |
|---------------------------------------|------------|------------|-------|------|-----|------|
|                                       |            |            | Min.  | Typ. | Max |      |
| CSB assertion to first clock edge     | $T_{SAC}$  |            | 120   | -    | -   | ns   |
| CSB de-assertion from last clock edge | $T_{CSD}$  |            | 120   | -    | -   | ns   |
| CSB next control enable               | $T_E$      |            | 200   | -    | -   | ns   |
| SCL period time                       | $T_{SCK}$  |            | 200   | -    | -   | ns   |
| SCL high period time                  | $T_{HWD}$  |            | 100   | -    | -   | ns   |
| SCL low period time                   | $T_{LWD}$  |            | 100   | -    | -   | ns   |
| SDA input data setup time             | $T_{DIST}$ |            | 50    | -    | -   | ns   |
| SDA input data hold time              | $T_{DIHT}$ |            | 50    | -    | -   | ns   |





| Parameter                  | Symbol      | Conditions        | Spec. |      |     | Unit |
|----------------------------|-------------|-------------------|-------|------|-----|------|
|                            |             |                   | Min.  | Typ. | Max |      |
| SCL clock frequency        | $f_{SCL}$   |                   | -     | -    | 400 | kHz  |
| STOP setup time            | $T_{SUSTO}$ |                   | 0.60  | -    | -   | uS   |
| START setup time           | $T_{SUSTA}$ |                   | 0.60  | -    | -   | uS   |
| START hold time            | $T_{HDSTA}$ |                   | 0.60  | -    | -   | uS   |
| SCL clock pulse width low  | $T_{LOW}$   |                   | 1.20  | -    | -   | uS   |
| SCL clock pulse width high | $T_{HIGH}$  |                   | 0.60  | -    | -   | uS   |
| Data hold time             | $T_{HDDAT}$ |                   | 0     | -    | -   | uS   |
| Data setup time            | $T_{SUDAT}$ |                   | 100   | -    | -   | nS   |
| IIC bus rise time          | $T_R$       |                   | -     | -    | 300 | nS   |
| IIC bus fall time          | $T_F$       | Output clock duty | -     | -    | 300 | nS   |

**14.4 Timing requirements for RESETB**

When RESETB of the reset pin equals to Low, it will be in the condition of reset. When it is in the condition of reset, it will make the device recover the initial set.

However, in order to avoid the reset noise cause reset, there is a mechanism to judge about whether the reset is needed or not.

The closed interval of Low can be shown as the following.

(Test condition: VDDIO=2.3V~3.6V, VSS=0V, TA=-30 ~+85 )

| Parameter             | Symbol | Conditions | Spec. |      |     | Unit |
|-----------------------|--------|------------|-------|------|-----|------|
|                       |        |            | Min.  | Typ. | Max |      |
| Reset low pulse width | Trst   |            | 20    | -    | -   | μs   |

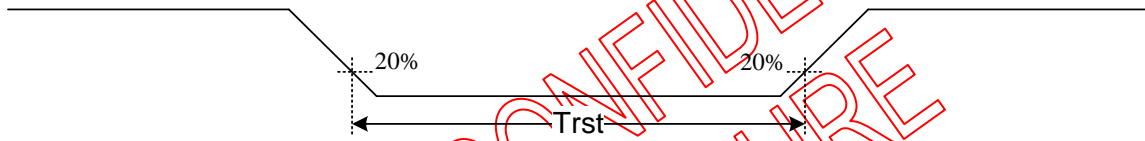
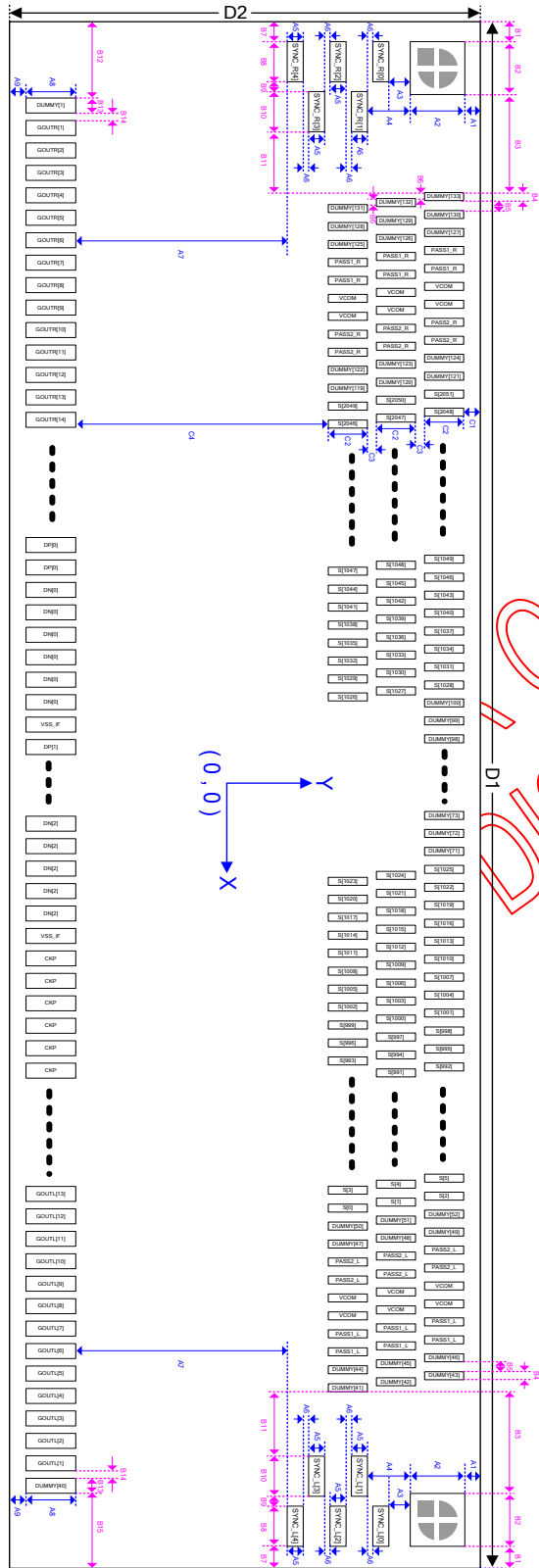

Figure 13.5: Reset timing

FITIPOWER CONFIDENTIAL  
NO DISCLOSURE

15. Chip Outline Dimension



CONFIDENTIAL  
DISCLOSURE

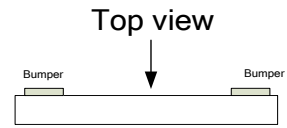

| Symbol | Dimension |
|--------|-----------|
| A1     | 50        |
| A2     | 100       |
| A3     | 31        |
| A4     | 71        |
| A5     | 30        |
| A6     | 10        |
| A7     | 395       |
| A8     | 93        |
| A9     | 41        |

| Symbol | Dimension |
|--------|-----------|
| B1     | 50        |
| B2     | 100       |
| B3     | 202       |
| B4     | 16        |
| B5     | 20        |
| B6     | 12        |
| B7     | 50        |
| B8     | 80        |
| B9     | 20        |

| Symbol | Dimension |
|--------|-----------|
| B10    | 80        |
| B11    | 122       |
| B12    | 162       |
| B13    | 30        |
| B14    | 15        |
| B15    | 163       |
| -      | -         |
| -      | -         |
| -      | -         |

| Symbol | Dimension |
|--------|-----------|
| C1     | 41        |
| C2     | 73        |
| C3     | 17        |
| C4     | 472       |
| D1     | 27600     |
| D2     | 900       |
| -      | -         |
| -      | -         |
| -      | -         |

Unit : um  
 Bump High=9um  
 Die size with ScribeLine

15.1 Alignment mark

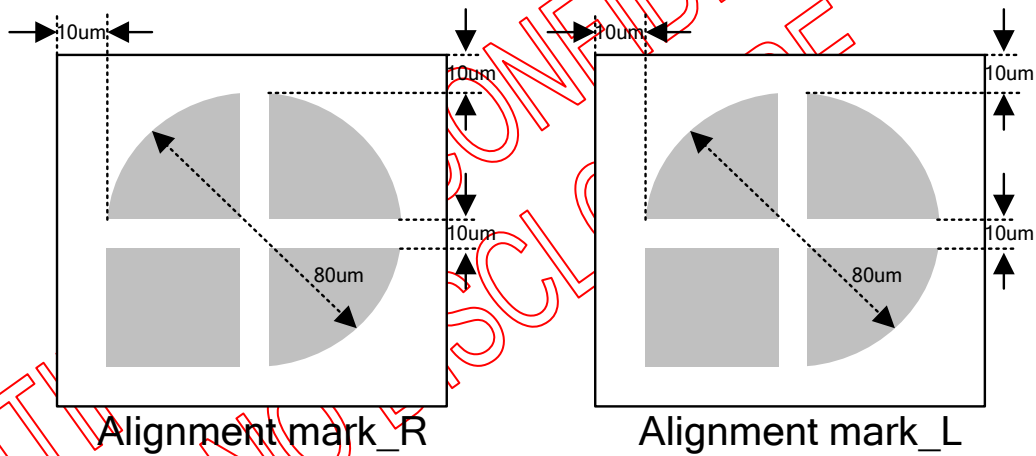

| ALM      | X – axis | Y – axis |
|----------|----------|----------|
| A_MARK_R | -13700   | 350      |
| A_MARK_L | 13700    | 350      |

## 15.2 Pad Coordinate

| Pin | Pad name  | X-axis   | Y-axis | Pin | Pad name  | X-axis   | Y-axis | Pin | Pad name | X-axis  | Y-axis |
|-----|-----------|----------|--------|-----|-----------|----------|--------|-----|----------|---------|--------|
| 1   | SYNC_R[0] | -13710   | 254    | 58  | VGH       | -11272.5 | -362.5 | 115 | TP[15]   | -8707.5 | -362.5 |
| 2   | SYNC_R[1] | -13610   | 214    | 59  | VGH       | -11227.5 | -362.5 | 116 | TP[16]   | -8662.5 | -362.5 |
| 3   | SYNC_R[2] | -13710   | 174    | 60  | T_S[1996] | -11182.5 | -362.5 | 117 | TP[17]   | -8617.5 | -362.5 |
| 4   | SYNC_R[3] | -13610   | 134    | 61  | T_S[1995] | -11137.5 | -362.5 | 118 | CAS      | -8572.5 | -362.5 |
| 5   | SYNC_R[4] | -13710   | 94     | 62  | VGH_REG   | -11092.5 | -362.5 | 119 | VSS      | -8527.5 | -362.5 |
| 6   | DUMMY[1]  | -13622.5 | -362.5 | 63  | VGH_REG   | -11047.5 | -362.5 | 120 | SDLOC    | -8482.5 | -362.5 |
| 7   | GOUTR[1]  | -13577.5 | -362.5 | 64  | VGH_REG   | -11002.5 | -362.5 | 121 | SDLOC    | -8437.5 | -362.5 |
| 8   | GOUTR[2]  | -13532.5 | -362.5 | 65  | VGH_REG   | -10957.5 | -362.5 | 122 | ZIGZAG   | -8392.5 | -362.5 |
| 9   | GOUTR[3]  | -13487.5 | -362.5 | 66  | VGH_REG   | -10912.5 | -362.5 | 123 | ZIGZAG   | -8347.5 | -362.5 |
| 10  | GOUTR[4]  | -13442.5 | -362.5 | 67  | VSN       | -10867.5 | -362.5 | 124 | ZTYPE    | -8302.5 | -362.5 |
| 11  | GOUTR[5]  | -13397.5 | -362.5 | 68  | VSN       | -10822.5 | -362.5 | 125 | ZTYPE    | -8257.5 | -362.5 |
| 12  | GOUTR[6]  | -13352.5 | -362.5 | 69  | VSN       | -10777.5 | -362.5 | 126 | TP[18]   | -8212.5 | -362.5 |
| 13  | GOUTR[7]  | -13307.5 | -362.5 | 70  | VSN       | -10732.5 | -362.5 | 127 | TP[19]   | -8167.5 | -362.5 |
| 14  | GOUTR[8]  | -13262.5 | -362.5 | 71  | VSN       | -10687.5 | -362.5 | 128 | TP[20]   | -8122.5 | -362.5 |
| 15  | GOUTR[9]  | -13217.5 | -362.5 | 72  | VSN       | -10642.5 | -362.5 | 129 | TP[21]   | -8077.5 | -362.5 |
| 16  | GOUTR[10] | -13172.5 | -362.5 | 73  | VSN       | -10597.5 | -362.5 | 130 | TP[22]   | -8032.5 | -362.5 |
| 17  | GOUTR[11] | -13127.5 | -362.5 | 74  | VSP       | -10552.5 | -362.5 | 131 | TP[23]   | -7987.5 | -362.5 |
| 18  | GOUTR[12] | -13082.5 | -362.5 | 75  | VSP       | -10507.5 | -362.5 | 132 | TP[24]   | -7942.5 | -362.5 |
| 19  | GOUTR[13] | -13037.5 | -362.5 | 76  | VSP       | -10462.5 | -362.5 | 133 | TP[25]   | -7897.5 | -362.5 |
| 20  | GOUTR[14] | -12992.5 | -362.5 | 77  | VSP       | -10417.5 | -362.5 | 134 | TP[26]   | -7852.5 | -362.5 |
| 21  | GOUTR[15] | -12947.5 | -362.5 | 78  | VSP       | -10372.5 | -362.5 | 135 | TP[27]   | -7807.5 | -362.5 |
| 22  | GOUTR[16] | -12902.5 | -362.5 | 79  | VSP       | -10327.5 | -362.5 | 136 | TP[28]   | -7762.5 | -362.5 |
| 23  | GOUTR[17] | -12857.5 | -362.5 | 80  | VSP       | -10282.5 | -362.5 | 137 | TP[29]   | -7717.5 | -362.5 |
| 24  | GOUTR[18] | -12812.5 | -362.5 | 81  | VSSA      | -10237.5 | -362.5 | 138 | TP[30]   | -7672.5 | -362.5 |
| 25  | GOUTR[19] | -12767.5 | -362.5 | 82  | VSSA      | -10192.5 | -362.5 | 139 | TP[31]   | -7627.5 | -362.5 |
| 26  | GOUTR[20] | -12722.5 | -362.5 | 83  | VSSA      | -10147.5 | -362.5 | 140 | TP[32]   | -7582.5 | -362.5 |
| 27  | GOUTR[21] | -12677.5 | -362.5 | 84  | VSSA      | -10102.5 | -362.5 | 141 | TP[33]   | -7537.5 | -362.5 |
| 28  | GOUTR[22] | -12632.5 | -362.5 | 85  | VSSA      | -10057.5 | -362.5 | 142 | TP[34]   | -7492.5 | -362.5 |
| 29  | PASS1_R   | -12587.5 | -362.5 | 86  | VSSA      | -10012.5 | -362.5 | 143 | TP[35]   | -7447.5 | -362.5 |
| 30  | PASS1_R   | -12542.5 | -362.5 | 87  | VSSA      | -9967.5  | -362.5 | 144 | TP[36]   | -7402.5 | -362.5 |
| 31  | PASS1_R   | -12497.5 | -362.5 | 88  | VSSA      | -9922.5  | -362.5 | 145 | TP[37]   | -7357.5 | -362.5 |
| 32  | VCOM      | -12442.5 | -362.5 | 89  | VSS       | -9877.5  | -362.5 | 146 | TP[38]   | -7312.5 | -362.5 |
| 33  | VCOM      | -12397.5 | -362.5 | 90  | VSS       | -9832.5  | -362.5 | 147 | TP[39]   | -7267.5 | -362.5 |
| 34  | VCOM      | -12352.5 | -362.5 | 91  | VSS       | -9787.5  | -362.5 | 148 | TP[40]   | -7222.5 | -362.5 |
| 35  | VCOM      | -12307.5 | -362.5 | 92  | VSS       | -9742.5  | -362.5 | 149 | TP[41]   | -7177.5 | -362.5 |
| 36  | PASS2_R   | -12262.5 | -362.5 | 93  | VSS       | -9697.5  | -362.5 | 150 | TP[42]   | -7132.5 | -362.5 |
| 37  | PASS2_R   | -12217.5 | -362.5 | 94  | VSS       | -9652.5  | -362.5 | 151 | RESETB   | -7087.5 | -362.5 |
| 38  | PASS2_R   | -12172.5 | -362.5 | 95  | VSS       | -9607.5  | -362.5 | 152 | RESETB   | -7042.5 | -362.5 |
| 39  | VGL       | -12127.5 | -362.5 | 96  | VSS       | -9562.5  | -362.5 | 153 | RESETB   | -6997.5 | -362.5 |
| 40  | VGL       | -12082.5 | -362.5 | 97  | VDD_15V   | -9517.5  | -362.5 | 154 | RESETB   | -6952.5 | -362.5 |
| 41  | VGL       | -12037.5 | -362.5 | 98  | VDD_15V   | -9472.5  | -362.5 | 155 | LNSW[1]  | -6907.5 | -362.5 |
| 42  | VGL       | -11992.5 | -362.5 | 99  | VDD_15V   | -9427.5  | -362.5 | 156 | LNSW[1]  | -6862.5 | -362.5 |
| 43  | VGL       | -11947.5 | -362.5 | 100 | TP[0]     | -9382.5  | -362.5 | 157 | LNSW[0]  | -6817.5 | -362.5 |
| 44  | VGL       | -11902.5 | -362.5 | 101 | TP[1]     | -9337.5  | -362.5 | 158 | LNSW[0]  | -6772.5 | -362.5 |
| 45  | VGL       | -11857.5 | -362.5 | 102 | TP[2]     | -9292.5  | -362.5 | 159 | PNSW     | -6727.5 | -362.5 |
| 46  | VGL_REG   | -11812.5 | -362.5 | 103 | TP[3]     | -9247.5  | -362.5 | 160 | PNSW     | -6682.5 | -362.5 |
| 47  | VGL_REG   | -11767.5 | -362.5 | 104 | TP[4]     | -9202.5  | -362.5 | 161 | IFSEL[1] | -6637.5 | -362.5 |
| 48  | VGL_REG   | -11722.5 | -362.5 | 105 | TP[5]     | -9157.5  | -362.5 | 162 | IFSEL[1] | -6592.5 | -362.5 |
| 49  | VGL_REG   | -11677.5 | -362.5 | 106 | TP[6]     | -9112.5  | -362.5 | 163 | IFSEL[0] | -6547.5 | -362.5 |
| 50  | VGL_REG   | -11632.5 | -362.5 | 107 | TP[7]     | -9067.5  | -362.5 | 164 | IFSEL[0] | -6502.5 | -362.5 |
| 51  | VGL_REG   | -11587.5 | -362.5 | 108 | TP[8]     | -9022.5  | -362.5 | 165 | RES[2]   | -6457.5 | -362.5 |
| 52  | VGL_REG   | -11542.5 | -362.5 | 109 | TP[9]     | -8977.5  | -362.5 | 166 | VSS      | -6412.5 | -362.5 |
| 53  | VGH       | -11497.5 | -362.5 | 110 | TP[10]    | -8932.5  | -362.5 | 167 | RES[1]   | -6367.5 | -362.5 |
| 54  | VGH       | -11452.5 | -362.5 | 111 | TP[11]    | -8887.5  | -362.5 | 168 | VSS      | -6322.5 | -362.5 |
| 55  | VGH       | -11407.5 | -362.5 | 112 | TP[12]    | -8842.5  | -362.5 | 169 | RES[0]   | -6277.5 | -362.5 |
| 56  | VGH       | -11362.5 | -362.5 | 113 | TP[13]    | -8797.5  | -362.5 | 170 | VSS      | -6232.5 | -362.5 |

|    |     |          |        |     |        |         |        |     |            |         |        |
|----|-----|----------|--------|-----|--------|---------|--------|-----|------------|---------|--------|
| 57 | VGH | -11317.5 | -362.5 | 114 | TP[14] | -8752.5 | -362.5 | 171 | GATE_SW[1] | -6187.5 | -362.5 |
|----|-----|----------|--------|-----|--------|---------|--------|-----|------------|---------|--------|

| Pin | Pad name     | X-axis  | Y-axis | Pin | Pad name  | X-axis  | Y-axis | Pin | Pad name | X-axis  | Y-axis |
|-----|--------------|---------|--------|-----|-----------|---------|--------|-----|----------|---------|--------|
| 172 | GATE_SW[1]   | -6142.5 | -362.5 | 229 | VDD       | -3577.5 | -362.5 | 286 | DP[0]    | -1012.5 | -362.5 |
| 173 | GATE_SW[0]   | -6097.5 | -362.5 | 230 | VDD       | -3532.5 | -362.5 | 287 | DP[0]    | -967.5  | -362.5 |
| 174 | GATE_SW[0]   | -6052.5 | -362.5 | 231 | VDD       | -3487.5 | -362.5 | 288 | DP[0]    | -922.5  | -362.5 |
| 175 | OP_DRV[1]    | -6007.5 | -362.5 | 232 | VCL       | -3442.5 | -362.5 | 289 | DP[0]    | -877.5  | -362.5 |
| 176 | OP_DRV[1]    | -5962.5 | -362.5 | 233 | VCL       | -3397.5 | -362.5 | 290 | DP[0]    | -832.5  | -362.5 |
| 177 | OP_DRV[0]    | -5917.5 | -362.5 | 234 | VCL       | -3352.5 | -362.5 | 291 | DP[0]    | -787.5  | -362.5 |
| 178 | OP_DRV[0]    | -5872.5 | -362.5 | 235 | VCL       | -3307.5 | -362.5 | 292 | DN[0]    | -742.5  | -362.5 |
| 179 | GIP_LRSEL[1] | -5827.5 | -362.5 | 236 | VCL       | -3262.5 | -362.5 | 293 | DN[0]    | -697.5  | -362.5 |
| 180 | VSS          | -5782.5 | -362.5 | 237 | VSN       | -3217.5 | -362.5 | 294 | DN[0]    | -652.5  | -362.5 |
| 181 | GIP_LRSEL[0] | -5737.5 | -362.5 | 238 | VSN       | -3172.5 | -362.5 | 295 | DN[0]    | -607.5  | -362.5 |
| 182 | VSS          | -5692.5 | -362.5 | 239 | VSN       | -3127.5 | -362.5 | 296 | DN[0]    | -562.5  | -362.5 |
| 183 | DVCOM_EN     | -5647.5 | -362.5 | 240 | VSN       | -3082.5 | -362.5 | 297 | DN[0]    | -517.5  | -362.5 |
| 184 | DVCOM_EN     | -5602.5 | -362.5 | 241 | VSN       | -3037.5 | -362.5 | 298 | VSS_IF   | -472.5  | -362.5 |
| 185 | DITHER_EN    | -5557.5 | -362.5 | 242 | VSN       | -2992.5 | -362.5 | 299 | DP[1]    | -427.5  | -362.5 |
| 186 | DITHER_EN    | -5512.5 | -362.5 | 243 | VSN       | -2947.5 | -362.5 | 300 | DP[1]    | -382.5  | -362.5 |
| 187 | HFRC_EN      | -5467.5 | -362.5 | 244 | VSN       | -2902.5 | -362.5 | 301 | DP[1]    | -337.5  | -362.5 |
| 188 | HFRC_EN      | -5422.5 | -362.5 | 245 | VSP       | -2857.5 | -362.5 | 302 | DP[1]    | -292.5  | -362.5 |
| 189 | STBYB        | -5377.5 | -362.5 | 246 | VSP       | -2812.5 | -362.5 | 303 | DP[1]    | -247.5  | -362.5 |
| 190 | STBYB        | -5332.5 | -362.5 | 247 | VSP       | -2767.5 | -362.5 | 304 | DP[1]    | -202.5  | -362.5 |
| 191 | BISTB        | -5287.5 | -362.5 | 248 | VSP       | -2722.5 | -362.5 | 305 | DN[1]    | -157.5  | -362.5 |
| 192 | BISTB        | -5242.5 | -362.5 | 249 | VSP       | -2677.5 | -362.5 | 306 | DN[1]    | -112.5  | -362.5 |
| 193 | CMD_SEL      | -5197.5 | -362.5 | 250 | VSP       | -2632.5 | -362.5 | 307 | DN[1]    | -67.5   | -362.5 |
| 194 | CMD_SEL      | -5152.5 | -362.5 | 251 | VSP       | -2587.5 | -362.5 | 308 | DN[1]    | -22.5   | -362.5 |
| 195 | LVFMT        | -5107.5 | -362.5 | 252 | VSSA      | -2542.5 | -362.5 | 309 | DN[1]    | 22.5    | -362.5 |
| 196 | LVFMT        | -5062.5 | -362.5 | 253 | VSSA      | -2497.5 | -362.5 | 310 | DN[1]    | 67.5    | -362.5 |
| 197 | LVBIT        | -5017.5 | -362.5 | 254 | VSSA      | -2452.5 | -362.5 | 311 | VSS_IF   | 112.5   | -362.5 |
| 198 | LVBIT        | -4972.5 | -362.5 | 255 | VSSA      | -2407.5 | -362.5 | 312 | CKP      | 157.5   | -362.5 |
| 199 | SDA          | -4927.5 | -362.5 | 256 | VSSA      | -2362.5 | -362.5 | 313 | CKP      | 202.5   | -362.5 |
| 200 | SDA          | -4882.5 | -362.5 | 257 | VSSA      | -2317.5 | -362.5 | 314 | CKP      | 247.5   | -362.5 |
| 201 | SCL          | -4837.5 | -362.5 | 258 | VSSA      | -2272.5 | -362.5 | 315 | CKP      | 292.5   | -362.5 |
| 202 | SCL          | -4792.5 | -362.5 | 259 | VGMP      | -2227.5 | -362.5 | 316 | CKP      | 337.5   | -362.5 |
| 203 | CSB          | -4747.5 | -362.5 | 260 | VGMP      | -2182.5 | -362.5 | 317 | CKP      | 382.5   | -362.5 |
| 204 | CSB          | -4702.5 | -362.5 | 261 | VGMP      | -2137.5 | -362.5 | 318 | CKN      | 427.5   | -362.5 |
| 205 | FRAME        | -4657.5 | -362.5 | 262 | VGMP      | -2092.5 | -362.5 | 319 | CKN      | 472.5   | -362.5 |
| 206 | FRAME        | -4612.5 | -362.5 | 263 | VGMP      | -2047.5 | -362.5 | 320 | CKN      | 517.5   | -362.5 |
| 207 | DUMMY[2]     | -4567.5 | -362.5 | 264 | VGMP      | -2002.5 | -362.5 | 321 | CKN      | 562.5   | -362.5 |
| 208 | T_VTSEN[2]   | -4522.5 | -362.5 | 265 | VGMP      | -1957.5 | -362.5 | 322 | CKN      | 607.5   | -362.5 |
| 209 | T_VTSEN[1]   | -4477.5 | -362.5 | 266 | VGMP      | -1912.5 | -362.5 | 323 | CKN      | 652.5   | -362.5 |
| 210 | T_VTSEN[0]   | -4432.5 | -362.5 | 267 | VGMP      | -1867.5 | -362.5 | 324 | VSS_IF   | 697.5   | -362.5 |
| 211 | LEDON        | -4387.5 | -362.5 | 268 | VGMP      | -1822.5 | -362.5 | 325 | DP[2]    | 742.5   | -362.5 |
| 212 | LEDON        | -4342.5 | -362.5 | 269 | VGMP      | -1777.5 | -362.5 | 326 | DP[2]    | 787.5   | -362.5 |
| 213 | LEDPWM       | -4297.5 | -362.5 | 270 | VGMP      | -1732.5 | -362.5 | 327 | DP[2]    | 832.5   | -362.5 |
| 214 | LEDPWM       | -4252.5 | -362.5 | 271 | DUMMY[4]  | -1687.5 | -362.5 | 328 | DP[2]    | 877.5   | -362.5 |
| 215 | PWR_EN       | -4207.5 | -362.5 | 272 | DUMMY[5]  | -1642.5 | -362.5 | 329 | DP[2]    | 922.5   | -362.5 |
| 216 | PWR_EN       | -4162.5 | -362.5 | 273 | DUMMY[6]  | -1597.5 | -362.5 | 330 | DP[2]    | 967.5   | -362.5 |
| 217 | DUMMY[3]     | -4117.5 | -362.5 | 274 | DUMMY[7]  | -1552.5 | -362.5 | 331 | DN[2]    | 1012.5  | -362.5 |
| 218 | TP[43]       | -4072.5 | -362.5 | 275 | DUMMY[8]  | -1507.5 | -362.5 | 332 | DN[2]    | 1057.5  | -362.5 |
| 219 | TP[44]       | -4027.5 | -362.5 | 276 | DUMMY[9]  | -1462.5 | -362.5 | 333 | DN[2]    | 1102.5  | -362.5 |
| 220 | VDDIO        | -3982.5 | -362.5 | 277 | DUMMY[10] | -1417.5 | -362.5 | 334 | DN[2]    | 1147.5  | -362.5 |
| 221 | VDDIO        | -3937.5 | -362.5 | 278 | VSS_IF    | -1372.5 | -362.5 | 335 | DN[2]    | 1192.5  | -362.5 |
| 222 | VDDIO        | -3892.5 | -362.5 | 279 | VSS_IF    | -1327.5 | -362.5 | 336 | DN[2]    | 1237.5  | -362.5 |
| 223 | VDDIO        | -3847.5 | -362.5 | 280 | VSS_IF    | -1282.5 | -362.5 | 337 | VSS_IF   | 1282.5  | -362.5 |
| 224 | VDDIO        | -3802.5 | -362.5 | 281 | VSS_IF    | -1237.5 | -362.5 | 338 | DP[3]    | 1327.5  | -362.5 |
| 225 | VDDIO        | -3757.5 | -362.5 | 282 | VSS_IF    | -1192.5 | -362.5 | 339 | DP[3]    | 1372.5  | -362.5 |
| 226 | VDD          | -3712.5 | -362.5 | 283 | VSS_IF    | -1147.5 | -362.5 | 340 | DP[3]    | 1417.5  | -362.5 |
| 227 | VDD          | -3667.5 | -362.5 | 284 | VSS_IF    | -1102.5 | -362.5 | 341 | DP[3]    | 1462.5  | -362.5 |
| 228 | VDD          | -3622.5 | -362.5 | 285 | VSS_IF    | -1057.5 | -362.5 | 342 | DP[3]    | 1507.5  | -362.5 |

| Pin | Pad name   | X-axis | Y-axis | Pin | Pad name  | X-axis | Y-axis | Pin | Pad name   | X-axis | Y-axis |
|-----|------------|--------|--------|-----|-----------|--------|--------|-----|------------|--------|--------|
| 343 | DP[3]      | 1552.5 | -362.5 | 400 | VDD_15V   | 4117.5 | -362.5 | 457 | TP[59]     | 6682.5 | -362.5 |
| 344 | DN[3]      | 1597.5 | -362.5 | 401 | VDD_15V   | 4162.5 | -362.5 | 458 | TP[60]     | 6727.5 | -362.5 |
| 345 | DN[3]      | 1642.5 | -362.5 | 402 | VDD_15V   | 4207.5 | -362.5 | 459 | TP[61]     | 6772.5 | -362.5 |
| 346 | DN[3]      | 1687.5 | -362.5 | 403 | VDD_15V   | 4252.5 | -362.5 | 460 | TP[62]     | 6817.5 | -362.5 |
| 347 | DN[3]      | 1732.5 | -362.5 | 404 | VDD_15V   | 4297.5 | -362.5 | 461 | TP[63]     | 6862.5 | -362.5 |
| 348 | DN[3]      | 1777.5 | -362.5 | 405 | VDD_15V   | 4342.5 | -362.5 | 462 | TP[64]     | 6907.5 | -362.5 |
| 349 | DN[3]      | 1822.5 | -362.5 | 406 | VDD_15V   | 4387.5 | -362.5 | 463 | TP[65]     | 6952.5 | -362.5 |
| 350 | VSS_IF     | 1867.5 | -362.5 | 407 | VDD       | 4432.5 | -362.5 | 464 | TP[66]     | 6997.5 | -362.5 |
| 351 | VSS_IF     | 1912.5 | -362.5 | 408 | VDD       | 4477.5 | -362.5 | 465 | TP[67]     | 7042.5 | -362.5 |
| 352 | DUMMY[11]  | 1957.5 | -362.5 | 409 | VDD       | 4522.5 | -362.5 | 466 | TP[68]     | 7087.5 | -362.5 |
| 353 | DUMMY[12]  | 2002.5 | -362.5 | 410 | VDD       | 4567.5 | -362.5 | 467 | TP[69]     | 7132.5 | -362.5 |
| 354 | TP[45]     | 2047.5 | -362.5 | 411 | VDD       | 4612.5 | -362.5 | 468 | TP[70]     | 7177.5 | -362.5 |
| 355 | TP[46]     | 2092.5 | -362.5 | 412 | VDD       | 4657.5 | -362.5 | 469 | CS_GIP     | 7222.5 | -362.5 |
| 356 | TP[47]     | 2137.5 | -362.5 | 413 | VDD       | 4702.5 | -362.5 | 470 | CS_GIP     | 7267.5 | -362.5 |
| 357 | TP[48]     | 2182.5 | -362.5 | 414 | VDD       | 4747.5 | -362.5 | 471 | CS_SD      | 7312.5 | -362.5 |
| 358 | TP[49]     | 2227.5 | -362.5 | 415 | VDD       | 4792.5 | -362.5 | 472 | CS_SD      | 7357.5 | -362.5 |
| 359 | TP[50]     | 2272.5 | -362.5 | 416 | VDD       | 4837.5 | -362.5 | 473 | DIR        | 7402.5 | -362.5 |
| 360 | VSS        | 2317.5 | -362.5 | 417 | VDD_IF    | 4882.5 | -362.5 | 474 | DIR        | 7447.5 | -362.5 |
| 361 | VSS        | 2362.5 | -362.5 | 418 | VDD_IF    | 4927.5 | -362.5 | 475 | REV        | 7492.5 | -362.5 |
| 362 | VSS        | 2407.5 | -362.5 | 419 | VDD_IF    | 4972.5 | -362.5 | 476 | REV        | 7537.5 | -362.5 |
| 363 | VSS        | 2452.5 | -362.5 | 420 | VDD_IF    | 5017.5 | -362.5 | 477 | TP[71]     | 7582.5 | -362.5 |
| 364 | VSS        | 2497.5 | -362.5 | 421 | VDD_IF    | 5062.5 | -362.5 | 478 | TP[72]     | 7627.5 | -362.5 |
| 365 | VSS        | 2542.5 | -362.5 | 422 | VDD_IF    | 5107.5 | -362.5 | 479 | TP[73]     | 7672.5 | -362.5 |
| 366 | VSS        | 2587.5 | -362.5 | 423 | VDD_IF    | 5152.5 | -362.5 | 480 | TP[74]     | 7717.5 | -362.5 |
| 367 | VSS        | 2632.5 | -362.5 | 424 | VDD_IF    | 5197.5 | -362.5 | 481 | A0         | 7762.5 | -362.5 |
| 368 | VSS        | 2677.5 | -362.5 | 425 | VDD_IF    | 5242.5 | -362.5 | 482 | A0         | 7807.5 | -362.5 |
| 369 | VSS        | 2722.5 | -362.5 | 426 | VDD_IF    | 5287.5 | -362.5 | 483 | DVCOM_WP   | 7852.5 | -362.5 |
| 370 | VSS        | 2767.5 | -362.5 | 427 | VDDIO     | 5332.5 | -362.5 | 484 | DVCOM_WP   | 7897.5 | -362.5 |
| 371 | VSS        | 2812.5 | -362.5 | 428 | VDDIO     | 5377.5 | -362.5 | 485 | SCL_I2C    | 7942.5 | -362.5 |
| 372 | VGH_REG    | 2857.5 | -362.5 | 429 | VDDIO     | 5422.5 | -362.5 | 486 | SCL_I2C    | 7987.5 | -362.5 |
| 373 | VGH_REG    | 2902.5 | -362.5 | 430 | VDDIO     | 5467.5 | -362.5 | 487 | SDA_I2C    | 8032.5 | -362.5 |
| 374 | VGH_REG    | 2947.5 | -362.5 | 431 | VDDIO     | 5512.5 | -362.5 | 488 | SDA_I2C    | 8077.5 | -362.5 |
| 375 | VGH_REG    | 2992.5 | -362.5 | 432 | VDDIO     | 5557.5 | -362.5 | 489 | SCAN_SEL   | 8122.5 | -362.5 |
| 376 | DUMMY[13]  | 3037.5 | -362.5 | 433 | VDDIO     | 5602.5 | -362.5 | 490 | SCAN_SEL   | 8167.5 | -362.5 |
| 377 | DUMMY[14]  | 3082.5 | -362.5 | 434 | VDDIO     | 5647.5 | -362.5 | 491 | INV_SEL[1] | 8212.5 | -362.5 |
| 378 | DUMMY[15]  | 3127.5 | -362.5 | 435 | VDDIO     | 5692.5 | -362.5 | 492 | INV_SEL[1] | 8257.5 | -362.5 |
| 379 | DUMMY[16]  | 3172.5 | -362.5 | 436 | VDDIO     | 5737.5 | -362.5 | 493 | INV_SEL[0] | 8302.5 | -362.5 |
| 380 | DUMMY[17]  | 3217.5 | -362.5 | 437 | DUMMY[20] | 5782.5 | -362.5 | 494 | INV_SEL[0] | 8347.5 | -362.5 |
| 381 | DUMMY[18]  | 3262.5 | -362.5 | 438 | DUMMY[21] | 5827.5 | -362.5 | 495 | DUMMY[30]  | 8392.5 | -362.5 |
| 382 | DUMMY[19]  | 3307.5 | -362.5 | 439 | DUMMY[22] | 5872.5 | -362.5 | 496 | TP[75]     | 8437.5 | -362.5 |
| 383 | VDD_15V_IF | 3352.5 | -362.5 | 440 | DUMMY[23] | 5917.5 | -362.5 | 497 | TP[76]     | 8482.5 | -362.5 |
| 384 | VDD_15V_IF | 3397.5 | -362.5 | 441 | DUMMY[24] | 5962.5 | -362.5 | 498 | TP[77]     | 8527.5 | -362.5 |
| 385 | VDD_15V_IF | 3442.5 | -362.5 | 442 | DUMMY[25] | 6007.5 | -362.5 | 499 | DUMMY[31]  | 8572.5 | -362.5 |
| 386 | VDD_15V_IF | 3487.5 | -362.5 | 443 | DUMMY[26] | 6052.5 | -362.5 | 500 | DUMMY[32]  | 8617.5 | -362.5 |
| 387 | VDD_15V_IF | 3532.5 | -362.5 | 444 | DUMMY[27] | 6097.5 | -362.5 | 501 | DUMMY[33]  | 8662.5 | -362.5 |
| 388 | VDD_15V_IF | 3577.5 | -362.5 | 445 | DUMMY[28] | 6142.5 | -362.5 | 502 | DUMMY[34]  | 8707.5 | -362.5 |
| 389 | VDD_15V_IF | 3622.5 | -362.5 | 446 | DUMMY[29] | 6187.5 | -362.5 | 503 | DUMMY[35]  | 8752.5 | -362.5 |
| 390 | VDD_15V_IF | 3667.5 | -362.5 | 447 | TP[51]    | 6232.5 | -362.5 | 504 | VSN        | 8797.5 | -362.5 |
| 391 | VDD_15V_IF | 3712.5 | -362.5 | 448 | TP[52]    | 6277.5 | -362.5 | 505 | VSN        | 8842.5 | -362.5 |
| 392 | VDD_15V_IF | 3757.5 | -362.5 | 449 | UPDN      | 6322.5 | -362.5 | 506 | VSN        | 8887.5 | -362.5 |
| 393 | VDD_15V_IF | 3802.5 | -362.5 | 450 | UPDN      | 6367.5 | -362.5 | 507 | VSN        | 8932.5 | -362.5 |
| 394 | VDD_15V_IF | 3847.5 | -362.5 | 451 | TP[53]    | 6412.5 | -362.5 | 508 | VSN        | 8977.5 | -362.5 |
| 395 | VDD_15V    | 3892.5 | -362.5 | 452 | TP[54]    | 6457.5 | -362.5 | 509 | VSN        | 9022.5 | -362.5 |
| 396 | VDD_15V    | 3937.5 | -362.5 | 453 | TP[55]    | 6502.5 | -362.5 | 510 | VSN        | 9067.5 | -362.5 |
| 397 | VDD_15V    | 3982.5 | -362.5 | 454 | TP[56]    | 6547.5 | -362.5 | 511 | VSP        | 9112.5 | -362.5 |
| 398 | VDD_15V    | 4027.5 | -362.5 | 455 | TP[57]    | 6592.5 | -362.5 | 512 | VSP        | 9157.5 | -362.5 |
| 399 | VDD_15V    | 4072.5 | -362.5 | 456 | TP[58]    | 6637.5 | -362.5 | 513 | VSP        | 9202.5 | -362.5 |

| Pin | Pad name | X-axis  | Y-axis | Pin | Pad name  | X-axis  | Y-axis | Pin | Pad name  | X-axis | Y-axis |
|-----|----------|---------|--------|-----|-----------|---------|--------|-----|-----------|--------|--------|
| 514 | VSP      | 9247.5  | -362.5 | 571 | VGL       | 11812.5 | -362.5 | 628 | PASS1_L   | 13308  | 372.5  |
| 515 | VSP      | 9292.5  | -362.5 | 572 | VGL       | 11857.5 | -362.5 | 629 | VCOM      | 13296  | 192.5  |
| 516 | VSP      | 9337.5  | -362.5 | 573 | VGL       | 11902.5 | -362.5 | 630 | VCOM      | 13284  | 282.5  |
| 517 | VSP      | 9382.5  | -362.5 | 574 | VGL       | 11947.5 | -362.5 | 631 | VCOM      | 13272  | 372.5  |
| 518 | VSSA     | 9427.5  | -362.5 | 575 | VGL       | 11992.5 | -362.5 | 632 | VCOM      | 13260  | 192.5  |
| 519 | VSSA     | 9472.5  | -362.5 | 576 | VGL       | 12037.5 | -362.5 | 633 | VCOM      | 13248  | 282.5  |
| 520 | VSSA     | 9517.5  | -362.5 | 577 | VGL       | 12082.5 | -362.5 | 634 | VCOM      | 13236  | 372.5  |
| 521 | VSSA     | 9562.5  | -362.5 | 578 | VGL       | 12127.5 | -362.5 | 635 | PASS2_L   | 13224  | 192.5  |
| 522 | VSSA     | 9607.5  | -362.5 | 579 | PASS2_L   | 12172.5 | -362.5 | 636 | PASS2_L   | 13212  | 282.5  |
| 523 | VSSA     | 9652.5  | -362.5 | 580 | PASS2_L   | 12217.5 | -362.5 | 637 | PASS2_L   | 13200  | 372.5  |
| 524 | VSSA     | 9697.5  | -362.5 | 581 | PASS2_L   | 12262.5 | -362.5 | 638 | PASS2_L   | 13188  | 192.5  |
| 525 | VSSA     | 9742.5  | -362.5 | 582 | VCOM      | 12307.5 | -362.5 | 639 | PASS2_L   | 13176  | 282.5  |
| 526 | VSS      | 9787.5  | -362.5 | 583 | VCOM      | 12352.5 | -362.5 | 640 | PASS2_L   | 13164  | 372.5  |
| 527 | VSS      | 9832.5  | -362.5 | 584 | VCOM      | 12397.5 | -362.5 | 641 | DUMMY[43] | 13152  | 192.5  |
| 528 | VSS      | 9877.5  | -362.5 | 585 | VCOM      | 12442.5 | -362.5 | 642 | DUMMY[44] | 13140  | 282.5  |
| 529 | VSS      | 9922.5  | -362.5 | 586 | PASS1_L   | 12487.5 | -362.5 | 643 | DUMMY[45] | 13128  | 372.5  |
| 530 | VSS      | 9967.5  | -362.5 | 587 | PASS1_L   | 12532.5 | -362.5 | 644 | DUMMY[46] | 13116  | 192.5  |
| 531 | VSS      | 10012.5 | -362.5 | 588 | PASS1_L   | 12577.5 | -362.5 | 645 | DUMMY[47] | 13104  | 282.5  |
| 532 | VSS      | 10057.5 | -362.5 | 589 | GOUTL[22] | 12622.5 | -362.5 | 646 | DUMMY[48] | 13092  | 372.5  |
| 533 | VDD_15V  | 10102.5 | -362.5 | 590 | GOUTL[21] | 12667.5 | -362.5 | 647 | S[0]      | 13080  | 192.5  |
| 534 | VDD_15V  | 10147.5 | -362.5 | 591 | GOUTL[20] | 12712.5 | -362.5 | 648 | S[1]      | 13068  | 282.5  |
| 535 | VDD_15V  | 10192.5 | -362.5 | 592 | GOUTL[19] | 12757.5 | -362.5 | 649 | S[2]      | 13056  | 372.5  |
| 536 | VDD_15V  | 10237.5 | -362.5 | 593 | GOUTL[18] | 12802.5 | -362.5 | 650 | S[3]      | 13044  | 192.5  |
| 537 | VDD_15V  | 10282.5 | -362.5 | 594 | GOUTL[17] | 12847.5 | -362.5 | 651 | S[4]      | 13032  | 282.5  |
| 538 | VDD_15V  | 10327.5 | -362.5 | 595 | GOUTL[16] | 12892.5 | -362.5 | 652 | S[5]      | 13020  | 372.5  |
| 539 | VGH_REG  | 10372.5 | -362.5 | 596 | GOUTL[15] | 12937.5 | -362.5 | 653 | S[6]      | 13008  | 192.5  |
| 540 | VGH_REG  | 10417.5 | -362.5 | 597 | GOUTL[14] | 12982.5 | -362.5 | 654 | S[7]      | 12996  | 282.5  |
| 541 | VGH_REG  | 10462.5 | -362.5 | 598 | GOUTL[13] | 13027.5 | -362.5 | 655 | S[8]      | 12984  | 372.5  |
| 542 | VGH_REG  | 10507.5 | -362.5 | 599 | GOUTL[12] | 13072.5 | -362.5 | 656 | S[9]      | 12972  | 192.5  |
| 543 | VGH_REG  | 10552.5 | -362.5 | 600 | GOUTL[11] | 13117.5 | -362.5 | 657 | S[10]     | 12960  | 282.5  |
| 544 | VGH_REG  | 10597.5 | -362.5 | 601 | GOUTL[10] | 13162.5 | -362.5 | 658 | S[11]     | 12948  | 372.5  |
| 545 | VGH_REG  | 10642.5 | -362.5 | 602 | GOUTL[9]  | 13207.5 | -362.5 | 659 | S[12]     | 12936  | 192.5  |
| 546 | VGH_REG  | 10687.5 | -362.5 | 603 | GOUTL[8]  | 13252.5 | -362.5 | 660 | S[13]     | 12924  | 282.5  |
| 547 | VGH_REG  | 10732.5 | -362.5 | 604 | GOUTL[7]  | 13297.5 | -362.5 | 661 | S[14]     | 12912  | 372.5  |
| 548 | VGH_REG  | 10777.5 | -362.5 | 605 | GOUTL[6]  | 13342.5 | -362.5 | 662 | S[15]     | 12900  | 192.5  |
| 549 | T_S[115] | 10822.5 | -362.5 | 606 | GOUTL[5]  | 13387.5 | -362.5 | 663 | S[16]     | 12888  | 282.5  |
| 550 | T_S[114] | 10867.5 | -362.5 | 607 | GOUTL[4]  | 13432.5 | -362.5 | 664 | S[17]     | 12876  | 372.5  |
| 551 | VGH      | 10912.5 | -362.5 | 608 | GOUTL[3]  | 13477.5 | -362.5 | 665 | S[18]     | 12864  | 192.5  |
| 552 | VGH      | 10957.5 | -362.5 | 609 | GOUTL[2]  | 13522.5 | -362.5 | 666 | S[19]     | 12852  | 282.5  |
| 553 | VGH      | 11002.5 | -362.5 | 610 | GOUTL[1]  | 13567.5 | -362.5 | 667 | S[20]     | 12840  | 372.5  |
| 554 | VGH      | 11047.5 | -362.5 | 611 | DUMMY[36] | 13612.5 | -362.5 | 668 | S[21]     | 12828  | 192.5  |
| 555 | VGH      | 11092.5 | -362.5 | 612 | SYNC_L[4] | 13710   | 94     | 669 | S[22]     | 12816  | 282.5  |
| 556 | VGH      | 11137.5 | -362.5 | 613 | SYNC_L[3] | 13610   | 134    | 670 | S[23]     | 12804  | 372.5  |
| 557 | VGH      | 11182.5 | -362.5 | 614 | SYNC_L[2] | 13710   | 174    | 671 | S[24]     | 12792  | 192.5  |
| 558 | VGH      | 11227.5 | -362.5 | 615 | SYNC_L[1] | 13610   | 214    | 672 | S[25]     | 12780  | 282.5  |
| 559 | VGH      | 11272.5 | -362.5 | 616 | SYNC_L[0] | 13710   | 254    | 673 | S[26]     | 12768  | 372.5  |
| 560 | VGH      | 11317.5 | -362.5 | 617 | DUMMY[37] | 13440   | 192.5  | 674 | S[27]     | 12756  | 192.5  |
| 561 | VGL_REG  | 11362.5 | -362.5 | 618 | DUMMY[38] | 13428   | 282.5  | 675 | S[28]     | 12744  | 282.5  |
| 562 | VGL_REG  | 11407.5 | -362.5 | 619 | DUMMY[39] | 13416   | 372.5  | 676 | S[29]     | 12732  | 372.5  |
| 563 | VGL_REG  | 11452.5 | -362.5 | 620 | DUMMY[40] | 13404   | 192.5  | 677 | S[30]     | 12720  | 192.5  |
| 564 | VGL_REG  | 11497.5 | -362.5 | 621 | DUMMY[41] | 13392   | 282.5  | 678 | S[31]     | 12708  | 282.5  |
| 565 | VGL_REG  | 11542.5 | -362.5 | 622 | DUMMY[42] | 13380   | 372.5  | 679 | S[32]     | 12696  | 372.5  |
| 566 | VGL_REG  | 11587.5 | -362.5 | 623 | PASS1_L   | 13368   | 192.5  | 680 | S[33]     | 12684  | 192.5  |
| 567 | VGL_REG  | 11632.5 | -362.5 | 624 | PASS1_L   | 13356   | 282.5  | 681 | S[34]     | 12672  | 282.5  |
| 568 | VGL_REG  | 11677.5 | -362.5 | 625 | PASS1_L   | 13344   | 372.5  | 682 | S[35]     | 12660  | 372.5  |
| 569 | VGL      | 11722.5 | -362.5 | 626 | PASS1_L   | 13332   | 192.5  | 683 | S[36]     | 12648  | 192.5  |
| 570 | VGL      | 11767.5 | -362.5 | 627 | PASS1_L   | 13320   | 282.5  | 684 | S[37]     | 12636  | 282.5  |



| Pin | Pad name | X-axis | Y-axis | Pin | Pad name | X-axis | Y-axis | Pin | Pad name | X-axis | Y-axis |
|-----|----------|--------|--------|-----|----------|--------|--------|-----|----------|--------|--------|
| 685 | S[38]    | 12624  | 372.5  | 742 | S[95]    | 11940  | 372.5  | 799 | S[152]   | 11256  | 372.5  |
| 686 | S[39]    | 12612  | 192.5  | 743 | S[96]    | 11928  | 192.5  | 800 | S[153]   | 11244  | 192.5  |
| 687 | S[40]    | 12600  | 282.5  | 744 | S[97]    | 11916  | 282.5  | 801 | S[154]   | 11232  | 282.5  |
| 688 | S[41]    | 12588  | 372.5  | 745 | S[98]    | 11904  | 372.5  | 802 | S[155]   | 11220  | 372.5  |
| 689 | S[42]    | 12576  | 192.5  | 746 | S[99]    | 11892  | 192.5  | 803 | S[156]   | 11208  | 192.5  |
| 690 | S[43]    | 12564  | 282.5  | 747 | S[100]   | 11880  | 282.5  | 804 | S[157]   | 11196  | 282.5  |
| 691 | S[44]    | 12552  | 372.5  | 748 | S[101]   | 11868  | 372.5  | 805 | S[158]   | 11184  | 372.5  |
| 692 | S[45]    | 12540  | 192.5  | 749 | S[102]   | 11856  | 192.5  | 806 | S[159]   | 11172  | 192.5  |
| 693 | S[46]    | 12528  | 282.5  | 750 | S[103]   | 11844  | 282.5  | 807 | S[160]   | 11160  | 282.5  |
| 694 | S[47]    | 12516  | 372.5  | 751 | S[104]   | 11832  | 372.5  | 808 | S[161]   | 11148  | 372.5  |
| 695 | S[48]    | 12504  | 192.5  | 752 | S[105]   | 11820  | 192.5  | 809 | S[162]   | 11136  | 192.5  |
| 696 | S[49]    | 12492  | 282.5  | 753 | S[106]   | 11808  | 282.5  | 810 | S[163]   | 11124  | 282.5  |
| 697 | S[50]    | 12480  | 372.5  | 754 | S[107]   | 11796  | 372.5  | 811 | S[164]   | 11112  | 372.5  |
| 698 | S[51]    | 12468  | 192.5  | 755 | S[108]   | 11784  | 192.5  | 812 | S[165]   | 11100  | 192.5  |
| 699 | S[52]    | 12456  | 282.5  | 756 | S[109]   | 11772  | 282.5  | 813 | S[166]   | 11088  | 282.5  |
| 700 | S[53]    | 12444  | 372.5  | 757 | S[110]   | 11760  | 372.5  | 814 | S[167]   | 11076  | 372.5  |
| 701 | S[54]    | 12432  | 192.5  | 758 | S[111]   | 11748  | 192.5  | 815 | S[168]   | 11064  | 192.5  |
| 702 | S[55]    | 12420  | 282.5  | 759 | S[112]   | 11736  | 282.5  | 816 | S[169]   | 11052  | 282.5  |
| 703 | S[56]    | 12408  | 372.5  | 760 | S[113]   | 11724  | 372.5  | 817 | S[170]   | 11040  | 372.5  |
| 704 | S[57]    | 12396  | 192.5  | 761 | S[114]   | 11712  | 192.5  | 818 | S[171]   | 11028  | 192.5  |
| 705 | S[58]    | 12384  | 282.5  | 762 | S[115]   | 11700  | 282.5  | 819 | S[172]   | 11016  | 282.5  |
| 706 | S[59]    | 12372  | 372.5  | 763 | S[116]   | 11688  | 372.5  | 820 | S[173]   | 11004  | 372.5  |
| 707 | S[60]    | 12360  | 192.5  | 764 | S[117]   | 11676  | 192.5  | 821 | S[174]   | 10992  | 192.5  |
| 708 | S[61]    | 12348  | 282.5  | 765 | S[118]   | 11664  | 282.5  | 822 | S[175]   | 10980  | 282.5  |
| 709 | S[62]    | 12336  | 372.5  | 766 | S[119]   | 11652  | 372.5  | 823 | S[176]   | 10968  | 372.5  |
| 710 | S[63]    | 12324  | 192.5  | 767 | S[120]   | 11640  | 192.5  | 824 | S[177]   | 10956  | 192.5  |
| 711 | S[64]    | 12312  | 282.5  | 768 | S[121]   | 11628  | 282.5  | 825 | S[178]   | 10944  | 282.5  |
| 712 | S[65]    | 12300  | 372.5  | 769 | S[122]   | 11616  | 372.5  | 826 | S[179]   | 10932  | 372.5  |
| 713 | S[66]    | 12288  | 192.5  | 770 | S[123]   | 11604  | 192.5  | 827 | S[180]   | 10920  | 192.5  |
| 714 | S[67]    | 12276  | 282.5  | 771 | S[124]   | 11592  | 282.5  | 828 | S[181]   | 10908  | 282.5  |
| 715 | S[68]    | 12264  | 372.5  | 772 | S[125]   | 11580  | 372.5  | 829 | S[182]   | 10896  | 372.5  |
| 716 | S[69]    | 12252  | 192.5  | 773 | S[126]   | 11568  | 192.5  | 830 | S[183]   | 10884  | 192.5  |
| 717 | S[70]    | 12240  | 282.5  | 774 | S[127]   | 11556  | 282.5  | 831 | S[184]   | 10872  | 282.5  |
| 718 | S[71]    | 12228  | 372.5  | 775 | S[128]   | 11544  | 372.5  | 832 | S[185]   | 10860  | 372.5  |
| 719 | S[72]    | 12216  | 192.5  | 776 | S[129]   | 11532  | 192.5  | 833 | S[186]   | 10848  | 192.5  |
| 720 | S[73]    | 12204  | 282.5  | 777 | S[130]   | 11520  | 282.5  | 834 | S[187]   | 10836  | 282.5  |
| 721 | S[74]    | 12192  | 372.5  | 778 | S[131]   | 11508  | 372.5  | 835 | S[188]   | 10824  | 372.5  |
| 722 | S[75]    | 12180  | 192.5  | 779 | S[132]   | 11496  | 192.5  | 836 | S[189]   | 10812  | 192.5  |
| 723 | S[76]    | 12168  | 282.5  | 780 | S[133]   | 11484  | 282.5  | 837 | S[190]   | 10800  | 282.5  |
| 724 | S[77]    | 12156  | 372.5  | 781 | S[134]   | 11472  | 372.5  | 838 | S[191]   | 10788  | 372.5  |
| 725 | S[78]    | 12144  | 192.5  | 782 | S[135]   | 11460  | 192.5  | 839 | S[192]   | 10776  | 192.5  |
| 726 | S[79]    | 12132  | 282.5  | 783 | S[136]   | 11448  | 282.5  | 840 | S[193]   | 10764  | 282.5  |
| 727 | S[80]    | 12120  | 372.5  | 784 | S[137]   | 11436  | 372.5  | 841 | S[194]   | 10752  | 372.5  |
| 728 | S[81]    | 12108  | 192.5  | 785 | S[138]   | 11424  | 192.5  | 842 | S[195]   | 10740  | 192.5  |
| 729 | S[82]    | 12096  | 282.5  | 786 | S[139]   | 11412  | 282.5  | 843 | S[196]   | 10728  | 282.5  |
| 730 | S[83]    | 12084  | 372.5  | 787 | S[140]   | 11400  | 372.5  | 844 | S[197]   | 10716  | 372.5  |
| 731 | S[84]    | 12072  | 192.5  | 788 | S[141]   | 11388  | 192.5  | 845 | S[198]   | 10704  | 192.5  |
| 732 | S[85]    | 12060  | 282.5  | 789 | S[142]   | 11376  | 282.5  | 846 | S[199]   | 10692  | 282.5  |
| 733 | S[86]    | 12048  | 372.5  | 790 | S[143]   | 11364  | 372.5  | 847 | S[200]   | 10680  | 372.5  |
| 734 | S[87]    | 12036  | 192.5  | 791 | S[144]   | 11352  | 192.5  | 848 | S[201]   | 10668  | 192.5  |
| 735 | S[88]    | 12024  | 282.5  | 792 | S[145]   | 11340  | 282.5  | 849 | S[202]   | 10656  | 282.5  |
| 736 | S[89]    | 12012  | 372.5  | 793 | S[146]   | 11328  | 372.5  | 850 | S[203]   | 10644  | 372.5  |
| 737 | S[90]    | 12000  | 192.5  | 794 | S[147]   | 11316  | 192.5  | 851 | S[204]   | 10632  | 192.5  |
| 738 | S[91]    | 11988  | 282.5  | 795 | S[148]   | 11304  | 282.5  | 852 | S[205]   | 10620  | 282.5  |
| 739 | S[92]    | 11976  | 372.5  | 796 | S[149]   | 11292  | 372.5  | 853 | S[206]   | 10608  | 372.5  |
| 740 | S[93]    | 11964  | 192.5  | 797 | S[150]   | 11280  | 192.5  | 854 | S[207]   | 10596  | 192.5  |
| 741 | S[94]    | 11952  | 282.5  | 798 | S[151]   | 11268  | 282.5  | 855 | S[208]   | 10584  | 282.5  |

| Pin | Pad name | X-axis | Y-axis | Pin | Pad name | X-axis | Y-axis | Pin  | Pad name | X-axis | Y-axis |
|-----|----------|--------|--------|-----|----------|--------|--------|------|----------|--------|--------|
| 856 | S[209]   | 10572  | 372.5  | 913 | S[266]   | 9888   | 372.5  | 970  | S[323]   | 9204   | 372.5  |
| 857 | S[210]   | 10560  | 192.5  | 914 | S[267]   | 9876   | 192.5  | 971  | S[324]   | 9192   | 192.5  |
| 858 | S[211]   | 10548  | 282.5  | 915 | S[268]   | 9864   | 282.5  | 972  | S[325]   | 9180   | 282.5  |
| 859 | S[212]   | 10536  | 372.5  | 916 | S[269]   | 9852   | 372.5  | 973  | S[326]   | 9168   | 372.5  |
| 860 | S[213]   | 10524  | 192.5  | 917 | S[270]   | 9840   | 192.5  | 974  | S[327]   | 9156   | 192.5  |
| 861 | S[214]   | 10512  | 282.5  | 918 | S[271]   | 9828   | 282.5  | 975  | S[328]   | 9144   | 282.5  |
| 862 | S[215]   | 10500  | 372.5  | 919 | S[272]   | 9816   | 372.5  | 976  | S[329]   | 9132   | 372.5  |
| 863 | S[216]   | 10488  | 192.5  | 920 | S[273]   | 9804   | 192.5  | 977  | S[330]   | 9120   | 192.5  |
| 864 | S[217]   | 10476  | 282.5  | 921 | S[274]   | 9792   | 282.5  | 978  | S[331]   | 9108   | 282.5  |
| 865 | S[218]   | 10464  | 372.5  | 922 | S[275]   | 9780   | 372.5  | 979  | S[332]   | 9096   | 372.5  |
| 866 | S[219]   | 10452  | 192.5  | 923 | S[276]   | 9768   | 192.5  | 980  | S[333]   | 9084   | 192.5  |
| 867 | S[220]   | 10440  | 282.5  | 924 | S[277]   | 9756   | 282.5  | 981  | S[334]   | 9072   | 282.5  |
| 868 | S[221]   | 10428  | 372.5  | 925 | S[278]   | 9744   | 372.5  | 982  | S[335]   | 9060   | 372.5  |
| 869 | S[222]   | 10416  | 192.5  | 926 | S[279]   | 9732   | 192.5  | 983  | S[336]   | 9048   | 192.5  |
| 870 | S[223]   | 10404  | 282.5  | 927 | S[280]   | 9720   | 282.5  | 984  | S[337]   | 9036   | 282.5  |
| 871 | S[224]   | 10392  | 372.5  | 928 | S[281]   | 9708   | 372.5  | 985  | S[338]   | 9024   | 372.5  |
| 872 | S[225]   | 10380  | 192.5  | 929 | S[282]   | 9696   | 192.5  | 986  | S[339]   | 9012   | 192.5  |
| 873 | S[226]   | 10368  | 282.5  | 930 | S[283]   | 9684   | 282.5  | 987  | S[340]   | 9000   | 282.5  |
| 874 | S[227]   | 10356  | 372.5  | 931 | S[284]   | 9672   | 372.5  | 988  | S[341]   | 8988   | 372.5  |
| 875 | S[228]   | 10344  | 192.5  | 932 | S[285]   | 9660   | 192.5  | 989  | S[342]   | 8976   | 192.5  |
| 876 | S[229]   | 10332  | 282.5  | 933 | S[286]   | 9648   | 282.5  | 990  | S[343]   | 8964   | 282.5  |
| 877 | S[230]   | 10320  | 372.5  | 934 | S[287]   | 9636   | 372.5  | 991  | S[344]   | 8952   | 372.5  |
| 878 | S[231]   | 10308  | 192.5  | 935 | S[288]   | 9624   | 192.5  | 992  | S[345]   | 8940   | 192.5  |
| 879 | S[232]   | 10296  | 282.5  | 936 | S[289]   | 9612   | 282.5  | 993  | S[346]   | 8928   | 282.5  |
| 880 | S[233]   | 10284  | 372.5  | 937 | S[290]   | 9600   | 372.5  | 994  | S[347]   | 8916   | 372.5  |
| 881 | S[234]   | 10272  | 192.5  | 938 | S[291]   | 9588   | 192.5  | 995  | S[348]   | 8904   | 192.5  |
| 882 | S[235]   | 10260  | 282.5  | 939 | S[292]   | 9576   | 282.5  | 996  | S[349]   | 8892   | 282.5  |
| 883 | S[236]   | 10248  | 372.5  | 940 | S[293]   | 9564   | 372.5  | 997  | S[350]   | 8880   | 372.5  |
| 884 | S[237]   | 10236  | 192.5  | 941 | S[294]   | 9552   | 192.5  | 998  | S[351]   | 8868   | 192.5  |
| 885 | S[238]   | 10224  | 282.5  | 942 | S[295]   | 9540   | 282.5  | 999  | S[352]   | 8856   | 282.5  |
| 886 | S[239]   | 10212  | 372.5  | 943 | S[296]   | 9528   | 372.5  | 1000 | S[353]   | 8844   | 372.5  |
| 887 | S[240]   | 10200  | 192.5  | 944 | S[297]   | 9516   | 192.5  | 1001 | S[354]   | 8832   | 192.5  |
| 888 | S[241]   | 10188  | 282.5  | 945 | S[298]   | 9504   | 282.5  | 1002 | S[355]   | 8820   | 282.5  |
| 889 | S[242]   | 10176  | 372.5  | 946 | S[299]   | 9492   | 372.5  | 1003 | S[356]   | 8808   | 372.5  |
| 890 | S[243]   | 10164  | 192.5  | 947 | S[300]   | 9480   | 192.5  | 1004 | S[357]   | 8796   | 192.5  |
| 891 | S[244]   | 10152  | 282.5  | 948 | S[301]   | 9468   | 282.5  | 1005 | S[358]   | 8784   | 282.5  |
| 892 | S[245]   | 10140  | 372.5  | 949 | S[302]   | 9456   | 372.5  | 1006 | S[359]   | 8772   | 372.5  |
| 893 | S[246]   | 10128  | 192.5  | 950 | S[303]   | 9444   | 192.5  | 1007 | S[360]   | 8760   | 192.5  |
| 894 | S[247]   | 10116  | 282.5  | 951 | S[304]   | 9432   | 282.5  | 1008 | S[361]   | 8748   | 282.5  |
| 895 | S[248]   | 10104  | 372.5  | 952 | S[305]   | 9420   | 372.5  | 1009 | S[362]   | 8736   | 372.5  |
| 896 | S[249]   | 10092  | 192.5  | 953 | S[306]   | 9408   | 192.5  | 1010 | S[363]   | 8724   | 192.5  |
| 897 | S[250]   | 10080  | 282.5  | 954 | S[307]   | 9396   | 282.5  | 1011 | S[364]   | 8712   | 282.5  |
| 898 | S[251]   | 10068  | 372.5  | 955 | S[308]   | 9384   | 372.5  | 1012 | S[365]   | 8700   | 372.5  |
| 899 | S[252]   | 10056  | 192.5  | 956 | S[309]   | 9372   | 192.5  | 1013 | S[366]   | 8688   | 192.5  |
| 900 | S[253]   | 10044  | 282.5  | 957 | S[310]   | 9360   | 282.5  | 1014 | S[367]   | 8676   | 282.5  |
| 901 | S[254]   | 10032  | 372.5  | 958 | S[311]   | 9348   | 372.5  | 1015 | S[368]   | 8664   | 372.5  |
| 902 | S[255]   | 10020  | 192.5  | 959 | S[312]   | 9336   | 192.5  | 1016 | S[369]   | 8652   | 192.5  |
| 903 | S[256]   | 10008  | 282.5  | 960 | S[313]   | 9324   | 282.5  | 1017 | S[370]   | 8640   | 282.5  |
| 904 | S[257]   | 9996   | 372.5  | 961 | S[314]   | 9312   | 372.5  | 1018 | S[371]   | 8628   | 372.5  |
| 905 | S[258]   | 9984   | 192.5  | 962 | S[315]   | 9300   | 192.5  | 1019 | S[372]   | 8616   | 192.5  |
| 906 | S[259]   | 9972   | 282.5  | 963 | S[316]   | 9288   | 282.5  | 1020 | S[373]   | 8604   | 282.5  |
| 907 | S[260]   | 9960   | 372.5  | 964 | S[317]   | 9276   | 372.5  | 1021 | S[374]   | 8592   | 372.5  |
| 908 | S[261]   | 9948   | 192.5  | 965 | S[318]   | 9264   | 192.5  | 1022 | S[375]   | 8580   | 192.5  |
| 909 | S[262]   | 9936   | 282.5  | 966 | S[319]   | 9252   | 282.5  | 1023 | S[376]   | 8568   | 282.5  |
| 910 | S[263]   | 9924   | 372.5  | 967 | S[320]   | 9240   | 372.5  | 1024 | S[377]   | 8556   | 372.5  |
| 911 | S[264]   | 9912   | 192.5  | 968 | S[321]   | 9228   | 192.5  | 1025 | S[378]   | 8544   | 192.5  |
| 912 | S[265]   | 9900   | 282.5  | 969 | S[322]   | 9216   | 282.5  | 1026 | S[379]   | 8532   | 282.5  |

| Pin  | Pad name | X-axis | Y-axis | Pin  | Pad name | X-axis | Y-axis | Pin  | Pad name  | X-axis | Y-axis |
|------|----------|--------|--------|------|----------|--------|--------|------|-----------|--------|--------|
| 1027 | S[380]   | 8520   | 372.5  | 1084 | S[437]   | 7836   | 372.5  | 1141 | S[494]    | 7152   | 372.5  |
| 1028 | S[381]   | 8508   | 192.5  | 1085 | S[438]   | 7824   | 192.5  | 1142 | S[495]    | 7140   | 192.5  |
| 1029 | S[382]   | 8496   | 282.5  | 1086 | S[439]   | 7812   | 282.5  | 1143 | S[496]    | 7128   | 282.5  |
| 1030 | S[383]   | 8484   | 372.5  | 1087 | S[440]   | 7800   | 372.5  | 1144 | S[497]    | 7116   | 372.5  |
| 1031 | S[384]   | 8472   | 192.5  | 1088 | S[441]   | 7788   | 192.5  | 1145 | S[498]    | 7104   | 192.5  |
| 1032 | S[385]   | 8460   | 282.5  | 1089 | S[442]   | 7776   | 282.5  | 1146 | S[499]    | 7092   | 282.5  |
| 1033 | S[386]   | 8448   | 372.5  | 1090 | S[443]   | 7764   | 372.5  | 1147 | S[500]    | 7080   | 372.5  |
| 1034 | S[387]   | 8436   | 192.5  | 1091 | S[444]   | 7752   | 192.5  | 1148 | S[501]    | 7068   | 192.5  |
| 1035 | S[388]   | 8424   | 282.5  | 1092 | S[445]   | 7740   | 282.5  | 1149 | S[502]    | 7056   | 282.5  |
| 1036 | S[389]   | 8412   | 372.5  | 1093 | S[446]   | 7728   | 372.5  | 1150 | S[503]    | 7044   | 372.5  |
| 1037 | S[390]   | 8400   | 192.5  | 1094 | S[447]   | 7716   | 192.5  | 1151 | S[504]    | 7032   | 192.5  |
| 1038 | S[391]   | 8388   | 282.5  | 1095 | S[448]   | 7704   | 282.5  | 1152 | S[505]    | 7020   | 282.5  |
| 1039 | S[392]   | 8376   | 372.5  | 1096 | S[449]   | 7692   | 372.5  | 1153 | S[506]    | 7008   | 372.5  |
| 1040 | S[393]   | 8364   | 192.5  | 1097 | S[450]   | 7680   | 192.5  | 1154 | S[507]    | 6996   | 192.5  |
| 1041 | S[394]   | 8352   | 282.5  | 1098 | S[451]   | 7668   | 282.5  | 1155 | S[508]    | 6984   | 282.5  |
| 1042 | S[395]   | 8340   | 372.5  | 1099 | S[452]   | 7656   | 372.5  | 1156 | S[509]    | 6972   | 372.5  |
| 1043 | S[396]   | 8328   | 192.5  | 1100 | S[453]   | 7644   | 192.5  | 1157 | S[510]    | 6960   | 192.5  |
| 1044 | S[397]   | 8316   | 282.5  | 1101 | S[454]   | 7632   | 282.5  | 1158 | S[511]    | 6948   | 282.5  |
| 1045 | S[398]   | 8304   | 372.5  | 1102 | S[455]   | 7620   | 372.5  | 1159 | S[512]    | 6936   | 372.5  |
| 1046 | S[399]   | 8292   | 192.5  | 1103 | S[456]   | 7608   | 192.5  | 1160 | DUMMY[49] | 6924   | 192.5  |
| 1047 | S[400]   | 8280   | 282.5  | 1104 | S[457]   | 7596   | 282.5  | 1161 | DUMMY[50] | 6912   | 282.5  |
| 1048 | S[401]   | 8268   | 372.5  | 1105 | S[458]   | 7584   | 372.5  | 1162 | DUMMY[51] | 6900   | 372.5  |
| 1049 | S[402]   | 8256   | 192.5  | 1106 | S[459]   | 7572   | 192.5  | 1163 | DUMMY[52] | 6888   | 192.5  |
| 1050 | S[403]   | 8244   | 282.5  | 1107 | S[460]   | 7560   | 282.5  | 1164 | DUMMY[53] | 6876   | 282.5  |
| 1051 | S[404]   | 8232   | 372.5  | 1108 | S[461]   | 7548   | 372.5  | 1165 | DUMMY[54] | 6864   | 372.5  |
| 1052 | S[405]   | 8220   | 192.5  | 1109 | S[462]   | 7536   | 192.5  | 1166 | DUMMY[55] | 6852   | 192.5  |
| 1053 | S[406]   | 8208   | 282.5  | 1110 | S[463]   | 7524   | 282.5  | 1167 | DUMMY[56] | 6840   | 282.5  |
| 1054 | S[407]   | 8196   | 372.5  | 1111 | S[464]   | 7512   | 372.5  | 1168 | DUMMY[57] | 6828   | 372.5  |
| 1055 | S[408]   | 8184   | 192.5  | 1112 | S[465]   | 7500   | 192.5  | 1169 | DUMMY[58] | 6816   | 192.5  |
| 1056 | S[409]   | 8172   | 282.5  | 1113 | S[466]   | 7488   | 282.5  | 1170 | DUMMY[59] | 6804   | 282.5  |
| 1057 | S[410]   | 8160   | 372.5  | 1114 | S[467]   | 7476   | 372.5  | 1171 | DUMMY[60] | 6792   | 372.5  |
| 1058 | S[411]   | 8148   | 192.5  | 1115 | S[468]   | 7464   | 192.5  | 1172 | DUMMY[61] | 6780   | 192.5  |
| 1059 | S[412]   | 8136   | 282.5  | 1116 | S[469]   | 7452   | 282.5  | 1173 | DUMMY[62] | 6768   | 282.5  |
| 1060 | S[413]   | 8124   | 372.5  | 1117 | S[470]   | 7440   | 372.5  | 1174 | DUMMY[63] | 6756   | 372.5  |
| 1061 | S[414]   | 8112   | 192.5  | 1118 | S[471]   | 7428   | 192.5  | 1175 | DUMMY[64] | 6744   | 192.5  |
| 1062 | S[415]   | 8100   | 282.5  | 1119 | S[472]   | 7416   | 282.5  | 1176 | DUMMY[65] | 6732   | 282.5  |
| 1063 | S[416]   | 8088   | 372.5  | 1120 | S[473]   | 7404   | 372.5  | 1177 | DUMMY[66] | 6720   | 372.5  |
| 1064 | S[417]   | 8076   | 192.5  | 1121 | S[474]   | 7392   | 192.5  | 1178 | S[513]    | 6708   | 192.5  |
| 1065 | S[418]   | 8064   | 282.5  | 1122 | S[475]   | 7380   | 282.5  | 1179 | S[514]    | 6696   | 282.5  |
| 1066 | S[419]   | 8052   | 372.5  | 1123 | S[476]   | 7368   | 372.5  | 1180 | S[515]    | 6684   | 372.5  |
| 1067 | S[420]   | 8040   | 192.5  | 1124 | S[477]   | 7356   | 192.5  | 1181 | S[516]    | 6672   | 192.5  |
| 1068 | S[421]   | 8028   | 282.5  | 1125 | S[478]   | 7344   | 282.5  | 1182 | S[517]    | 6660   | 282.5  |
| 1069 | S[422]   | 8016   | 372.5  | 1126 | S[479]   | 7332   | 372.5  | 1183 | S[518]    | 6648   | 372.5  |
| 1070 | S[423]   | 8004   | 192.5  | 1127 | S[480]   | 7320   | 192.5  | 1184 | S[519]    | 6636   | 192.5  |
| 1071 | S[424]   | 7992   | 282.5  | 1128 | S[481]   | 7308   | 282.5  | 1185 | S[520]    | 6624   | 282.5  |
| 1072 | S[425]   | 7980   | 372.5  | 1129 | S[482]   | 7296   | 372.5  | 1186 | S[521]    | 6612   | 372.5  |
| 1073 | S[426]   | 7968   | 192.5  | 1130 | S[483]   | 7284   | 192.5  | 1187 | S[522]    | 6600   | 192.5  |
| 1074 | S[427]   | 7956   | 282.5  | 1131 | S[484]   | 7272   | 282.5  | 1188 | S[523]    | 6588   | 282.5  |
| 1075 | S[428]   | 7944   | 372.5  | 1132 | S[485]   | 7260   | 372.5  | 1189 | S[524]    | 6576   | 372.5  |
| 1076 | S[429]   | 7932   | 192.5  | 1133 | S[486]   | 7248   | 192.5  | 1190 | S[525]    | 6564   | 192.5  |
| 1077 | S[430]   | 7920   | 282.5  | 1134 | S[487]   | 7236   | 282.5  | 1191 | S[526]    | 6552   | 282.5  |
| 1078 | S[431]   | 7908   | 372.5  | 1135 | S[488]   | 7224   | 372.5  | 1192 | S[527]    | 6540   | 372.5  |
| 1079 | S[432]   | 7896   | 192.5  | 1136 | S[489]   | 7212   | 192.5  | 1193 | S[528]    | 6528   | 192.5  |
| 1080 | S[433]   | 7884   | 282.5  | 1137 | S[490]   | 7200   | 282.5  | 1194 | S[529]    | 6516   | 282.5  |
| 1081 | S[434]   | 7872   | 372.5  | 1138 | S[491]   | 7188   | 372.5  | 1195 | S[530]    | 6504   | 372.5  |
| 1082 | S[435]   | 7860   | 192.5  | 1139 | S[492]   | 7176   | 192.5  | 1196 | S[531]    | 6492   | 192.5  |
| 1083 | S[436]   | 7848   | 282.5  | 1140 | S[493]   | 7164   | 282.5  | 1197 | S[532]    | 6480   | 282.5  |

| Pin  | Pad name | X-axis | Y-axis | Pin  | Pad name | X-axis | Y-axis | Pin  | Pad name | X-axis | Y-axis |
|------|----------|--------|--------|------|----------|--------|--------|------|----------|--------|--------|
| 1198 | S[533]   | 6468   | 372.5  | 1255 | S[590]   | 5784   | 372.5  | 1312 | S[647]   | 5100   | 372.5  |
| 1199 | S[534]   | 6456   | 192.5  | 1256 | S[591]   | 5772   | 192.5  | 1313 | S[648]   | 5088   | 192.5  |
| 1200 | S[535]   | 6444   | 282.5  | 1257 | S[592]   | 5760   | 282.5  | 1314 | S[649]   | 5076   | 282.5  |
| 1201 | S[536]   | 6432   | 372.5  | 1258 | S[593]   | 5748   | 372.5  | 1315 | S[650]   | 5064   | 372.5  |
| 1202 | S[537]   | 6420   | 192.5  | 1259 | S[594]   | 5736   | 192.5  | 1316 | S[651]   | 5052   | 192.5  |
| 1203 | S[538]   | 6408   | 282.5  | 1260 | S[595]   | 5724   | 282.5  | 1317 | S[652]   | 5040   | 282.5  |
| 1204 | S[539]   | 6396   | 372.5  | 1261 | S[596]   | 5712   | 372.5  | 1318 | S[653]   | 5028   | 372.5  |
| 1205 | S[540]   | 6384   | 192.5  | 1262 | S[597]   | 5700   | 192.5  | 1319 | S[654]   | 5016   | 192.5  |
| 1206 | S[541]   | 6372   | 282.5  | 1263 | S[598]   | 5688   | 282.5  | 1320 | S[655]   | 5004   | 282.5  |
| 1207 | S[542]   | 6360   | 372.5  | 1264 | S[599]   | 5676   | 372.5  | 1321 | S[656]   | 4992   | 372.5  |
| 1208 | S[543]   | 6348   | 192.5  | 1265 | S[600]   | 5664   | 192.5  | 1322 | S[657]   | 4980   | 192.5  |
| 1209 | S[544]   | 6336   | 282.5  | 1266 | S[601]   | 5652   | 282.5  | 1323 | S[658]   | 4968   | 282.5  |
| 1210 | S[545]   | 6324   | 372.5  | 1267 | S[602]   | 5640   | 372.5  | 1324 | S[659]   | 4956   | 372.5  |
| 1211 | S[546]   | 6312   | 192.5  | 1268 | S[603]   | 5628   | 192.5  | 1325 | S[660]   | 4944   | 192.5  |
| 1212 | S[547]   | 6300   | 282.5  | 1269 | S[604]   | 5616   | 282.5  | 1326 | S[661]   | 4932   | 282.5  |
| 1213 | S[548]   | 6288   | 372.5  | 1270 | S[605]   | 5604   | 372.5  | 1327 | S[662]   | 4920   | 372.5  |
| 1214 | S[549]   | 6276   | 192.5  | 1271 | S[606]   | 5592   | 192.5  | 1328 | S[663]   | 4908   | 192.5  |
| 1215 | S[550]   | 6264   | 282.5  | 1272 | S[607]   | 5580   | 282.5  | 1329 | S[664]   | 4896   | 282.5  |
| 1216 | S[551]   | 6252   | 372.5  | 1273 | S[608]   | 5568   | 372.5  | 1330 | S[665]   | 4884   | 372.5  |
| 1217 | S[552]   | 6240   | 192.5  | 1274 | S[609]   | 5556   | 192.5  | 1331 | S[666]   | 4872   | 192.5  |
| 1218 | S[553]   | 6228   | 282.5  | 1275 | S[610]   | 5544   | 282.5  | 1332 | S[667]   | 4860   | 282.5  |
| 1219 | S[554]   | 6216   | 372.5  | 1276 | S[611]   | 5532   | 372.5  | 1333 | S[668]   | 4848   | 372.5  |
| 1220 | S[555]   | 6204   | 192.5  | 1277 | S[612]   | 5520   | 192.5  | 1334 | S[669]   | 4836   | 192.5  |
| 1221 | S[556]   | 6192   | 282.5  | 1278 | S[613]   | 5508   | 282.5  | 1335 | S[670]   | 4824   | 282.5  |
| 1222 | S[557]   | 6180   | 372.5  | 1279 | S[614]   | 5496   | 372.5  | 1336 | S[671]   | 4812   | 372.5  |
| 1223 | S[558]   | 6168   | 192.5  | 1280 | S[615]   | 5484   | 192.5  | 1337 | S[672]   | 4800   | 192.5  |
| 1224 | S[559]   | 6156   | 282.5  | 1281 | S[616]   | 5472   | 282.5  | 1338 | S[673]   | 4788   | 282.5  |
| 1225 | S[560]   | 6144   | 372.5  | 1282 | S[617]   | 5460   | 372.5  | 1339 | S[674]   | 4776   | 372.5  |
| 1226 | S[561]   | 6132   | 192.5  | 1283 | S[618]   | 5448   | 192.5  | 1340 | S[675]   | 4764   | 192.5  |
| 1227 | S[562]   | 6120   | 282.5  | 1284 | S[619]   | 5436   | 282.5  | 1341 | S[676]   | 4752   | 282.5  |
| 1228 | S[563]   | 6108   | 372.5  | 1285 | S[620]   | 5424   | 372.5  | 1342 | S[677]   | 4740   | 372.5  |
| 1229 | S[564]   | 6096   | 192.5  | 1286 | S[621]   | 5412   | 192.5  | 1343 | S[678]   | 4728   | 192.5  |
| 1230 | S[565]   | 6084   | 282.5  | 1287 | S[622]   | 5400   | 282.5  | 1344 | S[679]   | 4716   | 282.5  |
| 1231 | S[566]   | 6072   | 372.5  | 1288 | S[623]   | 5388   | 372.5  | 1345 | S[680]   | 4704   | 372.5  |
| 1232 | S[567]   | 6060   | 192.5  | 1289 | S[624]   | 5376   | 192.5  | 1346 | S[681]   | 4692   | 192.5  |
| 1233 | S[568]   | 6048   | 282.5  | 1290 | S[625]   | 5364   | 282.5  | 1347 | S[682]   | 4680   | 282.5  |
| 1234 | S[569]   | 6036   | 372.5  | 1291 | S[626]   | 5352   | 372.5  | 1348 | S[683]   | 4668   | 372.5  |
| 1235 | S[570]   | 6024   | 192.5  | 1292 | S[627]   | 5340   | 192.5  | 1349 | S[684]   | 4656   | 192.5  |
| 1236 | S[571]   | 6012   | 282.5  | 1293 | S[628]   | 5328   | 282.5  | 1350 | S[685]   | 4644   | 282.5  |
| 1237 | S[572]   | 6000   | 372.5  | 1294 | S[629]   | 5316   | 372.5  | 1351 | S[686]   | 4632   | 372.5  |
| 1238 | S[573]   | 5988   | 192.5  | 1295 | S[630]   | 5304   | 192.5  | 1352 | S[687]   | 4620   | 192.5  |
| 1239 | S[574]   | 5976   | 282.5  | 1296 | S[631]   | 5292   | 282.5  | 1353 | S[688]   | 4608   | 282.5  |
| 1240 | S[575]   | 5964   | 372.5  | 1297 | S[632]   | 5280   | 372.5  | 1354 | S[689]   | 4596   | 372.5  |
| 1241 | S[576]   | 5952   | 192.5  | 1298 | S[633]   | 5268   | 192.5  | 1355 | S[690]   | 4584   | 192.5  |
| 1242 | S[577]   | 5940   | 282.5  | 1299 | S[634]   | 5256   | 282.5  | 1356 | S[691]   | 4572   | 282.5  |
| 1243 | S[578]   | 5928   | 372.5  | 1300 | S[635]   | 5244   | 372.5  | 1357 | S[692]   | 4560   | 372.5  |
| 1244 | S[579]   | 5916   | 192.5  | 1301 | S[636]   | 5232   | 192.5  | 1358 | S[693]   | 4548   | 192.5  |
| 1245 | S[580]   | 5904   | 282.5  | 1302 | S[637]   | 5220   | 282.5  | 1359 | S[694]   | 4536   | 282.5  |
| 1246 | S[581]   | 5892   | 372.5  | 1303 | S[638]   | 5208   | 372.5  | 1360 | S[695]   | 4524   | 372.5  |
| 1247 | S[582]   | 5880   | 192.5  | 1304 | S[639]   | 5196   | 192.5  | 1361 | S[696]   | 4512   | 192.5  |
| 1248 | S[583]   | 5868   | 282.5  | 1305 | S[640]   | 5184   | 282.5  | 1362 | S[697]   | 4500   | 282.5  |
| 1249 | S[584]   | 5856   | 372.5  | 1306 | S[641]   | 5172   | 372.5  | 1363 | S[698]   | 4488   | 372.5  |
| 1250 | S[585]   | 5844   | 192.5  | 1307 | S[642]   | 5160   | 192.5  | 1364 | S[699]   | 4476   | 192.5  |
| 1251 | S[586]   | 5832   | 282.5  | 1308 | S[643]   | 5148   | 282.5  | 1365 | S[700]   | 4464   | 282.5  |
| 1252 | S[587]   | 5820   | 372.5  | 1309 | S[644]   | 5136   | 372.5  | 1366 | S[701]   | 4452   | 372.5  |
| 1253 | S[588]   | 5808   | 192.5  | 1310 | S[645]   | 5124   | 192.5  | 1367 | S[702]   | 4440   | 192.5  |
| 1254 | S[589]   | 5796   | 282.5  | 1311 | S[646]   | 5112   | 282.5  | 1368 | S[703]   | 4428   | 282.5  |

| Pin  | Pad name | X-axis | Y-axis | Pin  | Pad name | X-axis | Y-axis | Pin  | Pad name | X-axis | Y-axis |
|------|----------|--------|--------|------|----------|--------|--------|------|----------|--------|--------|
| 1369 | S[704]   | 4416   | 372.5  | 1426 | S[761]   | 3732   | 372.5  | 1483 | S[818]   | 3048   | 372.5  |
| 1370 | S[705]   | 4404   | 192.5  | 1427 | S[762]   | 3720   | 192.5  | 1484 | S[819]   | 3036   | 192.5  |
| 1371 | S[706]   | 4392   | 282.5  | 1428 | S[763]   | 3708   | 282.5  | 1485 | S[820]   | 3024   | 282.5  |
| 1372 | S[707]   | 4380   | 372.5  | 1429 | S[764]   | 3696   | 372.5  | 1486 | S[821]   | 3012   | 372.5  |
| 1373 | S[708]   | 4368   | 192.5  | 1430 | S[765]   | 3684   | 192.5  | 1487 | S[822]   | 3000   | 192.5  |
| 1374 | S[709]   | 4356   | 282.5  | 1431 | S[766]   | 3672   | 282.5  | 1488 | S[823]   | 2988   | 282.5  |
| 1375 | S[710]   | 4344   | 372.5  | 1432 | S[767]   | 3660   | 372.5  | 1489 | S[824]   | 2976   | 372.5  |
| 1376 | S[711]   | 4332   | 192.5  | 1433 | S[768]   | 3648   | 192.5  | 1490 | S[825]   | 2964   | 192.5  |
| 1377 | S[712]   | 4320   | 282.5  | 1434 | S[769]   | 3636   | 282.5  | 1491 | S[826]   | 2952   | 282.5  |
| 1378 | S[713]   | 4308   | 372.5  | 1435 | S[770]   | 3624   | 372.5  | 1492 | S[827]   | 2940   | 372.5  |
| 1379 | S[714]   | 4296   | 192.5  | 1436 | S[771]   | 3612   | 192.5  | 1493 | S[828]   | 2928   | 192.5  |
| 1380 | S[715]   | 4284   | 282.5  | 1437 | S[772]   | 3600   | 282.5  | 1494 | S[829]   | 2916   | 282.5  |
| 1381 | S[716]   | 4272   | 372.5  | 1438 | S[773]   | 3588   | 372.5  | 1495 | S[830]   | 2904   | 372.5  |
| 1382 | S[717]   | 4260   | 192.5  | 1439 | S[774]   | 3576   | 192.5  | 1496 | S[831]   | 2892   | 192.5  |
| 1383 | S[718]   | 4248   | 282.5  | 1440 | S[775]   | 3564   | 282.5  | 1497 | S[832]   | 2880   | 282.5  |
| 1384 | S[719]   | 4236   | 372.5  | 1441 | S[776]   | 3552   | 372.5  | 1498 | S[833]   | 2868   | 372.5  |
| 1385 | S[720]   | 4224   | 192.5  | 1442 | S[777]   | 3540   | 192.5  | 1499 | S[834]   | 2856   | 192.5  |
| 1386 | S[721]   | 4212   | 282.5  | 1443 | S[778]   | 3528   | 282.5  | 1500 | S[835]   | 2844   | 282.5  |
| 1387 | S[722]   | 4200   | 372.5  | 1444 | S[779]   | 3516   | 372.5  | 1501 | S[836]   | 2832   | 372.5  |
| 1388 | S[723]   | 4188   | 192.5  | 1445 | S[780]   | 3504   | 192.5  | 1502 | S[837]   | 2820   | 192.5  |
| 1389 | S[724]   | 4176   | 282.5  | 1446 | S[781]   | 3492   | 282.5  | 1503 | S[838]   | 2808   | 282.5  |
| 1390 | S[725]   | 4164   | 372.5  | 1447 | S[782]   | 3480   | 372.5  | 1504 | S[839]   | 2796   | 372.5  |
| 1391 | S[726]   | 4152   | 192.5  | 1448 | S[783]   | 3468   | 192.5  | 1505 | S[840]   | 2784   | 192.5  |
| 1392 | S[727]   | 4140   | 282.5  | 1449 | S[784]   | 3456   | 282.5  | 1506 | S[841]   | 2772   | 282.5  |
| 1393 | S[728]   | 4128   | 372.5  | 1450 | S[785]   | 3444   | 372.5  | 1507 | S[842]   | 2760   | 372.5  |
| 1394 | S[729]   | 4116   | 192.5  | 1451 | S[786]   | 3432   | 192.5  | 1508 | S[843]   | 2748   | 192.5  |
| 1395 | S[730]   | 4104   | 282.5  | 1452 | S[787]   | 3420   | 282.5  | 1509 | S[844]   | 2736   | 282.5  |
| 1396 | S[731]   | 4092   | 372.5  | 1453 | S[788]   | 3408   | 372.5  | 1510 | S[845]   | 2724   | 372.5  |
| 1397 | S[732]   | 4080   | 192.5  | 1454 | S[789]   | 3396   | 192.5  | 1511 | S[846]   | 2712   | 192.5  |
| 1398 | S[733]   | 4068   | 282.5  | 1455 | S[790]   | 3384   | 282.5  | 1512 | S[847]   | 2700   | 282.5  |
| 1399 | S[734]   | 4056   | 372.5  | 1456 | S[791]   | 3372   | 372.5  | 1513 | S[848]   | 2688   | 372.5  |
| 1400 | S[735]   | 4044   | 192.5  | 1457 | S[792]   | 3360   | 192.5  | 1514 | S[849]   | 2676   | 192.5  |
| 1401 | S[736]   | 4032   | 282.5  | 1458 | S[793]   | 3348   | 282.5  | 1515 | S[850]   | 2664   | 282.5  |
| 1402 | S[737]   | 4020   | 372.5  | 1459 | S[794]   | 3336   | 372.5  | 1516 | S[851]   | 2652   | 372.5  |
| 1403 | S[738]   | 4008   | 192.5  | 1460 | S[795]   | 3324   | 192.5  | 1517 | S[852]   | 2640   | 192.5  |
| 1404 | S[739]   | 3996   | 282.5  | 1461 | S[796]   | 3312   | 282.5  | 1518 | S[853]   | 2628   | 282.5  |
| 1405 | S[740]   | 3984   | 372.5  | 1462 | S[797]   | 3300   | 372.5  | 1519 | S[854]   | 2616   | 372.5  |
| 1406 | S[741]   | 3972   | 192.5  | 1463 | S[798]   | 3288   | 192.5  | 1520 | S[855]   | 2604   | 192.5  |
| 1407 | S[742]   | 3960   | 282.5  | 1464 | S[799]   | 3276   | 282.5  | 1521 | S[856]   | 2592   | 282.5  |
| 1408 | S[743]   | 3948   | 372.5  | 1465 | S[800]   | 3264   | 372.5  | 1522 | S[857]   | 2580   | 372.5  |
| 1409 | S[744]   | 3936   | 192.5  | 1466 | S[801]   | 3252   | 192.5  | 1523 | S[858]   | 2568   | 192.5  |
| 1410 | S[745]   | 3924   | 282.5  | 1467 | S[802]   | 3240   | 282.5  | 1524 | S[859]   | 2556   | 282.5  |
| 1411 | S[746]   | 3912   | 372.5  | 1468 | S[803]   | 3228   | 372.5  | 1525 | S[860]   | 2544   | 372.5  |
| 1412 | S[747]   | 3900   | 192.5  | 1469 | S[804]   | 3216   | 192.5  | 1526 | S[861]   | 2532   | 192.5  |
| 1413 | S[748]   | 3888   | 282.5  | 1470 | S[805]   | 3204   | 282.5  | 1527 | S[862]   | 2520   | 282.5  |
| 1414 | S[749]   | 3876   | 372.5  | 1471 | S[806]   | 3192   | 372.5  | 1528 | S[863]   | 2508   | 372.5  |
| 1415 | S[750]   | 3864   | 192.5  | 1472 | S[807]   | 3180   | 192.5  | 1529 | S[864]   | 2496   | 192.5  |
| 1416 | S[751]   | 3852   | 282.5  | 1473 | S[808]   | 3168   | 282.5  | 1530 | S[865]   | 2484   | 282.5  |
| 1417 | S[752]   | 3840   | 372.5  | 1474 | S[809]   | 3156   | 372.5  | 1531 | S[866]   | 2472   | 372.5  |
| 1418 | S[753]   | 3828   | 192.5  | 1475 | S[810]   | 3144   | 192.5  | 1532 | S[867]   | 2460   | 192.5  |
| 1419 | S[754]   | 3816   | 282.5  | 1476 | S[811]   | 3132   | 282.5  | 1533 | S[868]   | 2448   | 282.5  |
| 1420 | S[755]   | 3804   | 372.5  | 1477 | S[812]   | 3120   | 372.5  | 1534 | S[869]   | 2436   | 372.5  |
| 1421 | S[756]   | 3792   | 192.5  | 1478 | S[813]   | 3108   | 192.5  | 1535 | S[870]   | 2424   | 192.5  |
| 1422 | S[757]   | 3780   | 282.5  | 1479 | S[814]   | 3096   | 282.5  | 1536 | S[871]   | 2412   | 282.5  |
| 1423 | S[758]   | 3768   | 372.5  | 1480 | S[815]   | 3084   | 372.5  | 1537 | S[872]   | 2400   | 372.5  |
| 1424 | S[759]   | 3756   | 192.5  | 1481 | S[816]   | 3072   | 192.5  | 1538 | S[873]   | 2388   | 192.5  |
| 1425 | S[760]   | 3744   | 282.5  | 1482 | S[817]   | 3060   | 282.5  | 1539 | S[874]   | 2376   | 282.5  |

| Pin  | Pad name | X-axis | Y-axis | Pin  | Pad name | X-axis | Y-axis | Pin  | Pad name  | X-axis | Y-axis |
|------|----------|--------|--------|------|----------|--------|--------|------|-----------|--------|--------|
| 1540 | S[875]   | 2364   | 372.5  | 1597 | S[932]   | 1680   | 372.5  | 1654 | S[989]    | 996    | 372.5  |
| 1541 | S[876]   | 2352   | 192.5  | 1598 | S[933]   | 1668   | 192.5  | 1655 | S[990]    | 984    | 192.5  |
| 1542 | S[877]   | 2340   | 282.5  | 1599 | S[934]   | 1656   | 282.5  | 1656 | S[991]    | 972    | 282.5  |
| 1543 | S[878]   | 2328   | 372.5  | 1600 | S[935]   | 1644   | 372.5  | 1657 | S[992]    | 960    | 372.5  |
| 1544 | S[879]   | 2316   | 192.5  | 1601 | S[936]   | 1632   | 192.5  | 1658 | S[993]    | 948    | 192.5  |
| 1545 | S[880]   | 2304   | 282.5  | 1602 | S[937]   | 1620   | 282.5  | 1659 | S[994]    | 936    | 282.5  |
| 1546 | S[881]   | 2292   | 372.5  | 1603 | S[938]   | 1608   | 372.5  | 1660 | S[995]    | 924    | 372.5  |
| 1547 | S[882]   | 2280   | 192.5  | 1604 | S[939]   | 1596   | 192.5  | 1661 | S[996]    | 912    | 192.5  |
| 1548 | S[883]   | 2268   | 282.5  | 1605 | S[940]   | 1584   | 282.5  | 1662 | S[997]    | 900    | 282.5  |
| 1549 | S[884]   | 2256   | 372.5  | 1606 | S[941]   | 1572   | 372.5  | 1663 | S[998]    | 888    | 372.5  |
| 1550 | S[885]   | 2244   | 192.5  | 1607 | S[942]   | 1560   | 192.5  | 1664 | S[999]    | 876    | 192.5  |
| 1551 | S[886]   | 2232   | 282.5  | 1608 | S[943]   | 1548   | 282.5  | 1665 | S[1000]   | 864    | 282.5  |
| 1552 | S[887]   | 2220   | 372.5  | 1609 | S[944]   | 1536   | 372.5  | 1666 | S[1001]   | 852    | 372.5  |
| 1553 | S[888]   | 2208   | 192.5  | 1610 | S[945]   | 1524   | 192.5  | 1667 | S[1002]   | 840    | 192.5  |
| 1554 | S[889]   | 2196   | 282.5  | 1611 | S[946]   | 1512   | 282.5  | 1668 | S[1003]   | 828    | 282.5  |
| 1555 | S[890]   | 2184   | 372.5  | 1612 | S[947]   | 1500   | 372.5  | 1669 | S[1004]   | 816    | 372.5  |
| 1556 | S[891]   | 2172   | 192.5  | 1613 | S[948]   | 1488   | 192.5  | 1670 | S[1005]   | 804    | 192.5  |
| 1557 | S[892]   | 2160   | 282.5  | 1614 | S[949]   | 1476   | 282.5  | 1671 | S[1006]   | 792    | 282.5  |
| 1558 | S[893]   | 2148   | 372.5  | 1615 | S[950]   | 1464   | 372.5  | 1672 | S[1007]   | 780    | 372.5  |
| 1559 | S[894]   | 2136   | 192.5  | 1616 | S[951]   | 1452   | 192.5  | 1673 | S[1008]   | 768    | 192.5  |
| 1560 | S[895]   | 2124   | 282.5  | 1617 | S[952]   | 1440   | 282.5  | 1674 | S[1009]   | 756    | 282.5  |
| 1561 | S[896]   | 2112   | 372.5  | 1618 | S[953]   | 1428   | 372.5  | 1675 | S[1010]   | 744    | 372.5  |
| 1562 | S[897]   | 2100   | 192.5  | 1619 | S[954]   | 1416   | 192.5  | 1676 | S[1011]   | 732    | 192.5  |
| 1563 | S[898]   | 2088   | 282.5  | 1620 | S[955]   | 1404   | 282.5  | 1677 | S[1012]   | 720    | 282.5  |
| 1564 | S[899]   | 2076   | 372.5  | 1621 | S[956]   | 1392   | 372.5  | 1678 | S[1013]   | 708    | 372.5  |
| 1565 | S[900]   | 2064   | 192.5  | 1622 | S[957]   | 1380   | 192.5  | 1679 | S[1014]   | 696    | 192.5  |
| 1566 | S[901]   | 2052   | 282.5  | 1623 | S[958]   | 1368   | 282.5  | 1680 | S[1015]   | 684    | 282.5  |
| 1567 | S[902]   | 2040   | 372.5  | 1624 | S[959]   | 1356   | 372.5  | 1681 | S[1016]   | 672    | 372.5  |
| 1568 | S[903]   | 2028   | 192.5  | 1625 | S[960]   | 1344   | 192.5  | 1682 | S[1017]   | 660    | 192.5  |
| 1569 | S[904]   | 2016   | 282.5  | 1626 | S[961]   | 1332   | 282.5  | 1683 | S[1018]   | 648    | 282.5  |
| 1570 | S[905]   | 2004   | 372.5  | 1627 | S[962]   | 1320   | 372.5  | 1684 | S[1019]   | 636    | 372.5  |
| 1571 | S[906]   | 1992   | 192.5  | 1628 | S[963]   | 1308   | 192.5  | 1685 | S[1020]   | 624    | 192.5  |
| 1572 | S[907]   | 1980   | 282.5  | 1629 | S[964]   | 1296   | 282.5  | 1686 | S[1021]   | 612    | 282.5  |
| 1573 | S[908]   | 1968   | 372.5  | 1630 | S[965]   | 1284   | 372.5  | 1687 | S[1022]   | 600    | 372.5  |
| 1574 | S[909]   | 1956   | 192.5  | 1631 | S[966]   | 1272   | 192.5  | 1688 | S[1023]   | 588    | 192.5  |
| 1575 | S[910]   | 1944   | 282.5  | 1632 | S[967]   | 1260   | 282.5  | 1689 | S[1024]   | 576    | 282.5  |
| 1576 | S[911]   | 1932   | 372.5  | 1633 | S[968]   | 1248   | 372.5  | 1690 | S[1025]   | 564    | 372.5  |
| 1577 | S[912]   | 1920   | 192.5  | 1634 | S[969]   | 1236   | 192.5  | 1691 | DUMMY[67] | 528    | 372.5  |
| 1578 | S[913]   | 1908   | 282.5  | 1635 | S[970]   | 1224   | 282.5  | 1692 | DUMMY[68] | 492    | 372.5  |
| 1579 | S[914]   | 1896   | 372.5  | 1636 | S[971]   | 1212   | 372.5  | 1693 | DUMMY[69] | 456    | 372.5  |
| 1580 | S[915]   | 1884   | 192.5  | 1637 | S[972]   | 1200   | 192.5  | 1694 | DUMMY[70] | 420    | 372.5  |
| 1581 | S[916]   | 1872   | 282.5  | 1638 | S[973]   | 1188   | 282.5  | 1695 | DUMMY[71] | 384    | 372.5  |
| 1582 | S[917]   | 1860   | 372.5  | 1639 | S[974]   | 1176   | 372.5  | 1696 | DUMMY[72] | 348    | 372.5  |
| 1583 | S[918]   | 1848   | 192.5  | 1640 | S[975]   | 1164   | 192.5  | 1697 | DUMMY[73] | 312    | 372.5  |
| 1584 | S[919]   | 1836   | 282.5  | 1641 | S[976]   | 1152   | 282.5  | 1698 | DUMMY[74] | 276    | 372.5  |
| 1585 | S[920]   | 1824   | 372.5  | 1642 | S[977]   | 1140   | 372.5  | 1699 | DUMMY[75] | 240    | 372.5  |
| 1586 | S[921]   | 1812   | 192.5  | 1643 | S[978]   | 1128   | 192.5  | 1700 | DUMMY[76] | 204    | 372.5  |
| 1587 | S[922]   | 1800   | 282.5  | 1644 | S[979]   | 1116   | 282.5  | 1701 | DUMMY[77] | 168    | 372.5  |
| 1588 | S[923]   | 1788   | 372.5  | 1645 | S[980]   | 1104   | 372.5  | 1702 | DUMMY[78] | 132    | 372.5  |
| 1589 | S[924]   | 1776   | 192.5  | 1646 | S[981]   | 1092   | 192.5  | 1703 | DUMMY[79] | 96     | 372.5  |
| 1590 | S[925]   | 1764   | 282.5  | 1647 | S[982]   | 1080   | 282.5  | 1704 | DUMMY[80] | 60     | 372.5  |
| 1591 | S[926]   | 1752   | 372.5  | 1648 | S[983]   | 1068   | 372.5  | 1705 | DUMMY[81] | 24     | 372.5  |
| 1592 | S[927]   | 1740   | 192.5  | 1649 | S[984]   | 1056   | 192.5  | 1706 | DUMMY[82] | -12    | 372.5  |
| 1593 | S[928]   | 1728   | 282.5  | 1650 | S[985]   | 1044   | 282.5  | 1707 | DUMMY[83] | -48    | 372.5  |
| 1594 | S[929]   | 1716   | 372.5  | 1651 | S[986]   | 1032   | 372.5  | 1708 | DUMMY[84] | -84    | 372.5  |
| 1595 | S[930]   | 1704   | 192.5  | 1652 | S[987]   | 1020   | 192.5  | 1709 | DUMMY[85] | -120   | 372.5  |
| 1596 | S[931]   | 1692   | 282.5  | 1653 | S[988]   | 1008   | 282.5  | 1710 | DUMMY[86] | -156   | 372.5  |



| Pin  | Pad name  | X-axis | Y-axis | Pin  | Pad name | X-axis | Y-axis | Pin  | Pad name | X-axis | Y-axis |
|------|-----------|--------|--------|------|----------|--------|--------|------|----------|--------|--------|
| 1711 | DUMMY[87] | -192   | 372.5  | 1768 | S[1073]  | -1092  | 372.5  | 1825 | S[1130]  | -1776  | 372.5  |
| 1712 | DUMMY[88] | -228   | 372.5  | 1769 | S[1074]  | -1104  | 192.5  | 1826 | S[1131]  | -1788  | 192.5  |
| 1713 | DUMMY[89] | -264   | 372.5  | 1770 | S[1075]  | -1116  | 282.5  | 1827 | S[1132]  | -1800  | 282.5  |
| 1714 | DUMMY[90] | -300   | 372.5  | 1771 | S[1076]  | -1128  | 372.5  | 1828 | S[1133]  | -1812  | 372.5  |
| 1715 | DUMMY[91] | -336   | 372.5  | 1772 | S[1077]  | -1140  | 192.5  | 1829 | S[1134]  | -1824  | 192.5  |
| 1716 | DUMMY[92] | -372   | 372.5  | 1773 | S[1078]  | -1152  | 282.5  | 1830 | S[1135]  | -1836  | 282.5  |
| 1717 | DUMMY[93] | -408   | 372.5  | 1774 | S[1079]  | -1164  | 372.5  | 1831 | S[1136]  | -1848  | 372.5  |
| 1718 | DUMMY[94] | -444   | 372.5  | 1775 | S[1080]  | -1176  | 192.5  | 1832 | S[1137]  | -1860  | 192.5  |
| 1719 | DUMMY[95] | -480   | 372.5  | 1776 | S[1081]  | -1188  | 282.5  | 1833 | S[1138]  | -1872  | 282.5  |
| 1720 | DUMMY[96] | -516   | 372.5  | 1777 | S[1082]  | -1200  | 372.5  | 1834 | S[1139]  | -1884  | 372.5  |
| 1721 | S[1026]   | -528   | 192.5  | 1778 | S[1083]  | -1212  | 192.5  | 1835 | S[1140]  | -1896  | 192.5  |
| 1722 | S[1027]   | -540   | 282.5  | 1779 | S[1084]  | -1224  | 282.5  | 1836 | S[1141]  | -1908  | 282.5  |
| 1723 | S[1028]   | -552   | 372.5  | 1780 | S[1085]  | -1236  | 372.5  | 1837 | S[1142]  | -1920  | 372.5  |
| 1724 | S[1029]   | -564   | 192.5  | 1781 | S[1086]  | -1248  | 192.5  | 1838 | S[1143]  | -1932  | 192.5  |
| 1725 | S[1030]   | -576   | 282.5  | 1782 | S[1087]  | -1260  | 282.5  | 1839 | S[1144]  | -1944  | 282.5  |
| 1726 | S[1031]   | -588   | 372.5  | 1783 | S[1088]  | -1272  | 372.5  | 1840 | S[1145]  | -1956  | 372.5  |
| 1727 | S[1032]   | -600   | 192.5  | 1784 | S[1089]  | -1284  | 192.5  | 1841 | S[1146]  | -1968  | 192.5  |
| 1728 | S[1033]   | -612   | 282.5  | 1785 | S[1090]  | -1296  | 282.5  | 1842 | S[1147]  | -1980  | 282.5  |
| 1729 | S[1034]   | -624   | 372.5  | 1786 | S[1091]  | -1308  | 372.5  | 1843 | S[1148]  | -1992  | 372.5  |
| 1730 | S[1035]   | -636   | 192.5  | 1787 | S[1092]  | -1320  | 192.5  | 1844 | S[1149]  | -2004  | 192.5  |
| 1731 | S[1036]   | -648   | 282.5  | 1788 | S[1093]  | -1332  | 282.5  | 1845 | S[1150]  | -2016  | 282.5  |
| 1732 | S[1037]   | -660   | 372.5  | 1789 | S[1094]  | -1344  | 372.5  | 1846 | S[1151]  | -2028  | 372.5  |
| 1733 | S[1038]   | -672   | 192.5  | 1790 | S[1095]  | -1356  | 192.5  | 1847 | S[1152]  | -2040  | 192.5  |
| 1734 | S[1039]   | -684   | 282.5  | 1791 | S[1096]  | -1368  | 282.5  | 1848 | S[1153]  | -2052  | 282.5  |
| 1735 | S[1040]   | -696   | 372.5  | 1792 | S[1097]  | -1380  | 372.5  | 1849 | S[1154]  | -2064  | 372.5  |
| 1736 | S[1041]   | -708   | 192.5  | 1793 | S[1098]  | -1392  | 192.5  | 1850 | S[1155]  | -2076  | 192.5  |
| 1737 | S[1042]   | -720   | 282.5  | 1794 | S[1099]  | -1404  | 282.5  | 1851 | S[1156]  | -2088  | 282.5  |
| 1738 | S[1043]   | -732   | 372.5  | 1795 | S[1100]  | -1416  | 372.5  | 1852 | S[1157]  | -2100  | 372.5  |
| 1739 | S[1044]   | -744   | 192.5  | 1796 | S[1101]  | -1428  | 192.5  | 1853 | S[1158]  | -2112  | 192.5  |
| 1740 | S[1045]   | -756   | 282.5  | 1797 | S[1102]  | -1440  | 282.5  | 1854 | S[1159]  | -2124  | 282.5  |
| 1741 | S[1046]   | -768   | 372.5  | 1798 | S[1103]  | -1452  | 372.5  | 1855 | S[1160]  | -2136  | 372.5  |
| 1742 | S[1047]   | -780   | 192.5  | 1799 | S[1104]  | -1464  | 192.5  | 1856 | S[1161]  | -2148  | 192.5  |
| 1743 | S[1048]   | -792   | 282.5  | 1800 | S[1105]  | -1476  | 282.5  | 1857 | S[1162]  | -2160  | 282.5  |
| 1744 | S[1049]   | -804   | 372.5  | 1801 | S[1106]  | -1488  | 372.5  | 1858 | S[1163]  | -2172  | 372.5  |
| 1745 | S[1050]   | -816   | 192.5  | 1802 | S[1107]  | -1500  | 192.5  | 1859 | S[1164]  | -2184  | 192.5  |
| 1746 | S[1051]   | -828   | 282.5  | 1803 | S[1108]  | -1512  | 282.5  | 1860 | S[1165]  | -2196  | 282.5  |
| 1747 | S[1052]   | -840   | 372.5  | 1804 | S[1109]  | -1524  | 372.5  | 1861 | S[1166]  | -2208  | 372.5  |
| 1748 | S[1053]   | -852   | 192.5  | 1805 | S[1110]  | -1536  | 192.5  | 1862 | S[1167]  | -2220  | 192.5  |
| 1749 | S[1054]   | -864   | 282.5  | 1806 | S[1111]  | -1548  | 282.5  | 1863 | S[1168]  | -2232  | 282.5  |
| 1750 | S[1055]   | -876   | 372.5  | 1807 | S[1112]  | -1560  | 372.5  | 1864 | S[1169]  | -2244  | 372.5  |
| 1751 | S[1056]   | -888   | 192.5  | 1808 | S[1113]  | -1572  | 192.5  | 1865 | S[1170]  | -2256  | 192.5  |
| 1752 | S[1057]   | -900   | 282.5  | 1809 | S[1114]  | -1584  | 282.5  | 1866 | S[1171]  | -2268  | 282.5  |
| 1753 | S[1058]   | -912   | 372.5  | 1810 | S[1115]  | -1596  | 372.5  | 1867 | S[1172]  | -2280  | 372.5  |
| 1754 | S[1059]   | -924   | 192.5  | 1811 | S[1116]  | -1608  | 192.5  | 1868 | S[1173]  | -2292  | 192.5  |
| 1755 | S[1060]   | -936   | 282.5  | 1812 | S[1117]  | -1620  | 282.5  | 1869 | S[1174]  | -2304  | 282.5  |
| 1756 | S[1061]   | -948   | 372.5  | 1813 | S[1118]  | -1632  | 372.5  | 1870 | S[1175]  | -2316  | 372.5  |
| 1757 | S[1062]   | -960   | 192.5  | 1814 | S[1119]  | -1644  | 192.5  | 1871 | S[1176]  | -2328  | 192.5  |
| 1758 | S[1063]   | -972   | 282.5  | 1815 | S[1120]  | -1656  | 282.5  | 1872 | S[1177]  | -2340  | 282.5  |
| 1759 | S[1064]   | -984   | 372.5  | 1816 | S[1121]  | -1668  | 372.5  | 1873 | S[1178]  | -2352  | 372.5  |
| 1760 | S[1065]   | -996   | 192.5  | 1817 | S[1122]  | -1680  | 192.5  | 1874 | S[1179]  | -2364  | 192.5  |
| 1761 | S[1066]   | -1008  | 282.5  | 1818 | S[1123]  | -1692  | 282.5  | 1875 | S[1180]  | -2376  | 282.5  |
| 1762 | S[1067]   | -1020  | 372.5  | 1819 | S[1124]  | -1704  | 372.5  | 1876 | S[1181]  | -2388  | 372.5  |
| 1763 | S[1068]   | -1032  | 192.5  | 1820 | S[1125]  | -1716  | 192.5  | 1877 | S[1182]  | -2400  | 192.5  |
| 1764 | S[1069]   | -1044  | 282.5  | 1821 | S[1126]  | -1728  | 282.5  | 1878 | S[1183]  | -2412  | 282.5  |
| 1765 | S[1070]   | -1056  | 372.5  | 1822 | S[1127]  | -1740  | 372.5  | 1879 | S[1184]  | -2424  | 372.5  |
| 1766 | S[1071]   | -1068  | 192.5  | 1823 | S[1128]  | -1752  | 192.5  | 1880 | S[1185]  | -2436  | 192.5  |
| 1767 | S[1072]   | -1080  | 282.5  | 1824 | S[1129]  | -1764  | 282.5  | 1881 | S[1186]  | -2448  | 282.5  |

| Pin  | Pad name | X-axis | Y-axis | Pin  | Pad name | X-axis | Y-axis | Pin  | Pad name | X-axis | Y-axis |
|------|----------|--------|--------|------|----------|--------|--------|------|----------|--------|--------|
| 1882 | S[1187]  | -2460  | 372.5  | 1939 | S[1244]  | -3144  | 372.5  | 1996 | S[1301]  | -3828  | 372.5  |
| 1883 | S[1188]  | -2472  | 192.5  | 1940 | S[1245]  | -3156  | 192.5  | 1997 | S[1302]  | -3840  | 192.5  |
| 1884 | S[1189]  | -2484  | 282.5  | 1941 | S[1246]  | -3168  | 282.5  | 1998 | S[1303]  | -3852  | 282.5  |
| 1885 | S[1190]  | -2496  | 372.5  | 1942 | S[1247]  | -3180  | 372.5  | 1999 | S[1304]  | -3864  | 372.5  |
| 1886 | S[1191]  | -2508  | 192.5  | 1943 | S[1248]  | -3192  | 192.5  | 2000 | S[1305]  | -3876  | 192.5  |
| 1887 | S[1192]  | -2520  | 282.5  | 1944 | S[1249]  | -3204  | 282.5  | 2001 | S[1306]  | -3888  | 282.5  |
| 1888 | S[1193]  | -2532  | 372.5  | 1945 | S[1250]  | -3216  | 372.5  | 2002 | S[1307]  | -3900  | 372.5  |
| 1889 | S[1194]  | -2544  | 192.5  | 1946 | S[1251]  | -3228  | 192.5  | 2003 | S[1308]  | -3912  | 192.5  |
| 1890 | S[1195]  | -2556  | 282.5  | 1947 | S[1252]  | -3240  | 282.5  | 2004 | S[1309]  | -3924  | 282.5  |
| 1891 | S[1196]  | -2568  | 372.5  | 1948 | S[1253]  | -3252  | 372.5  | 2005 | S[1310]  | -3936  | 372.5  |
| 1892 | S[1197]  | -2580  | 192.5  | 1949 | S[1254]  | -3264  | 192.5  | 2006 | S[1311]  | -3948  | 192.5  |
| 1893 | S[1198]  | -2592  | 282.5  | 1950 | S[1255]  | -3276  | 282.5  | 2007 | S[1312]  | -3960  | 282.5  |
| 1894 | S[1199]  | -2604  | 372.5  | 1951 | S[1256]  | -3288  | 372.5  | 2008 | S[1313]  | -3972  | 372.5  |
| 1895 | S[1200]  | -2616  | 192.5  | 1952 | S[1257]  | -3300  | 192.5  | 2009 | S[1314]  | -3984  | 192.5  |
| 1896 | S[1201]  | -2628  | 282.5  | 1953 | S[1258]  | -3312  | 282.5  | 2010 | S[1315]  | -3996  | 282.5  |
| 1897 | S[1202]  | -2640  | 372.5  | 1954 | S[1259]  | -3324  | 372.5  | 2011 | S[1316]  | -4008  | 372.5  |
| 1898 | S[1203]  | -2652  | 192.5  | 1955 | S[1260]  | -3336  | 192.5  | 2012 | S[1317]  | -4020  | 192.5  |
| 1899 | S[1204]  | -2664  | 282.5  | 1956 | S[1261]  | -3348  | 282.5  | 2013 | S[1318]  | -4032  | 282.5  |
| 1900 | S[1205]  | -2676  | 372.5  | 1957 | S[1262]  | -3360  | 372.5  | 2014 | S[1319]  | -4044  | 372.5  |
| 1901 | S[1206]  | -2688  | 192.5  | 1958 | S[1263]  | -3372  | 192.5  | 2015 | S[1320]  | -4056  | 192.5  |
| 1902 | S[1207]  | -2700  | 282.5  | 1959 | S[1264]  | -3384  | 282.5  | 2016 | S[1321]  | -4068  | 282.5  |
| 1903 | S[1208]  | -2712  | 372.5  | 1960 | S[1265]  | -3396  | 372.5  | 2017 | S[1322]  | -4080  | 372.5  |
| 1904 | S[1209]  | -2724  | 192.5  | 1961 | S[1266]  | -3408  | 192.5  | 2018 | S[1323]  | -4092  | 192.5  |
| 1905 | S[1210]  | -2736  | 282.5  | 1962 | S[1267]  | -3420  | 282.5  | 2019 | S[1324]  | -4104  | 282.5  |
| 1906 | S[1211]  | -2748  | 372.5  | 1963 | S[1268]  | -3432  | 372.5  | 2020 | S[1325]  | -4116  | 372.5  |
| 1907 | S[1212]  | -2760  | 192.5  | 1964 | S[1269]  | -3444  | 192.5  | 2021 | S[1326]  | -4128  | 192.5  |
| 1908 | S[1213]  | -2772  | 282.5  | 1965 | S[1270]  | -3456  | 282.5  | 2022 | S[1327]  | -4140  | 282.5  |
| 1909 | S[1214]  | -2784  | 372.5  | 1966 | S[1271]  | -3468  | 372.5  | 2023 | S[1328]  | -4152  | 372.5  |
| 1910 | S[1215]  | -2796  | 192.5  | 1967 | S[1272]  | -3480  | 192.5  | 2024 | S[1329]  | -4164  | 192.5  |
| 1911 | S[1216]  | -2808  | 282.5  | 1968 | S[1273]  | -3492  | 282.5  | 2025 | S[1330]  | -4176  | 282.5  |
| 1912 | S[1217]  | -2820  | 372.5  | 1969 | S[1274]  | -3504  | 372.5  | 2026 | S[1331]  | -4188  | 372.5  |
| 1913 | S[1218]  | -2832  | 192.5  | 1970 | S[1275]  | -3516  | 192.5  | 2027 | S[1332]  | -4200  | 192.5  |
| 1914 | S[1219]  | -2844  | 282.5  | 1971 | S[1276]  | -3528  | 282.5  | 2028 | S[1333]  | -4212  | 282.5  |
| 1915 | S[1220]  | -2856  | 372.5  | 1972 | S[1277]  | -3540  | 372.5  | 2029 | S[1334]  | -4224  | 372.5  |
| 1916 | S[1221]  | -2868  | 192.5  | 1973 | S[1278]  | -3552  | 192.5  | 2030 | S[1335]  | -4236  | 192.5  |
| 1917 | S[1222]  | -2880  | 282.5  | 1974 | S[1279]  | -3564  | 282.5  | 2031 | S[1336]  | -4248  | 282.5  |
| 1918 | S[1223]  | -2892  | 372.5  | 1975 | S[1280]  | -3576  | 372.5  | 2032 | S[1337]  | -4260  | 372.5  |
| 1919 | S[1224]  | -2904  | 192.5  | 1976 | S[1281]  | -3588  | 192.5  | 2033 | S[1338]  | -4272  | 192.5  |
| 1920 | S[1225]  | -2916  | 282.5  | 1977 | S[1282]  | -3600  | 282.5  | 2034 | S[1339]  | -4284  | 282.5  |
| 1921 | S[1226]  | -2928  | 372.5  | 1978 | S[1283]  | -3612  | 372.5  | 2035 | S[1340]  | -4296  | 372.5  |
| 1922 | S[1227]  | -2940  | 192.5  | 1979 | S[1284]  | -3624  | 192.5  | 2036 | S[1341]  | -4308  | 192.5  |
| 1923 | S[1228]  | -2952  | 282.5  | 1980 | S[1285]  | -3636  | 282.5  | 2037 | S[1342]  | -4320  | 282.5  |
| 1924 | S[1229]  | -2964  | 372.5  | 1981 | S[1286]  | -3648  | 372.5  | 2038 | S[1343]  | -4332  | 372.5  |
| 1925 | S[1230]  | -2976  | 192.5  | 1982 | S[1287]  | -3660  | 192.5  | 2039 | S[1344]  | -4344  | 192.5  |
| 1926 | S[1231]  | -2988  | 282.5  | 1983 | S[1288]  | -3672  | 282.5  | 2040 | S[1345]  | -4356  | 282.5  |
| 1927 | S[1232]  | -3000  | 372.5  | 1984 | S[1289]  | -3684  | 372.5  | 2041 | S[1346]  | -4368  | 372.5  |
| 1928 | S[1233]  | -3012  | 192.5  | 1985 | S[1290]  | -3696  | 192.5  | 2042 | S[1347]  | -4380  | 192.5  |
| 1929 | S[1234]  | -3024  | 282.5  | 1986 | S[1291]  | -3708  | 282.5  | 2043 | S[1348]  | -4392  | 282.5  |
| 1930 | S[1235]  | -3036  | 372.5  | 1987 | S[1292]  | -3720  | 372.5  | 2044 | S[1349]  | -4404  | 372.5  |
| 1931 | S[1236]  | -3048  | 192.5  | 1988 | S[1293]  | -3732  | 192.5  | 2045 | S[1350]  | -4416  | 192.5  |
| 1932 | S[1237]  | -3060  | 282.5  | 1989 | S[1294]  | -3744  | 282.5  | 2046 | S[1351]  | -4428  | 282.5  |
| 1933 | S[1238]  | -3072  | 372.5  | 1990 | S[1295]  | -3756  | 372.5  | 2047 | S[1352]  | -4440  | 372.5  |
| 1934 | S[1239]  | -3084  | 192.5  | 1991 | S[1296]  | -3768  | 192.5  | 2048 | S[1353]  | -4452  | 192.5  |
| 1935 | S[1240]  | -3096  | 282.5  | 1992 | S[1297]  | -3780  | 282.5  | 2049 | S[1354]  | -4464  | 282.5  |
| 1936 | S[1241]  | -3108  | 372.5  | 1993 | S[1298]  | -3792  | 372.5  | 2050 | S[1355]  | -4476  | 372.5  |
| 1937 | S[1242]  | -3120  | 192.5  | 1994 | S[1299]  | -3804  | 192.5  | 2051 | S[1356]  | -4488  | 192.5  |
| 1938 | S[1243]  | -3132  | 282.5  | 1995 | S[1300]  | -3816  | 282.5  | 2052 | S[1357]  | -4500  | 282.5  |



| Pin  | Pad name | X-axis | Y-axis | Pin  | Pad name | X-axis | Y-axis | Pin  | Pad name | X-axis | Y-axis |
|------|----------|--------|--------|------|----------|--------|--------|------|----------|--------|--------|
| 2053 | S[1358]  | -4512  | 372.5  | 2110 | S[1415]  | -5196  | 372.5  | 2167 | S[1472]  | -5880  | 372.5  |
| 2054 | S[1359]  | -4524  | 192.5  | 2111 | S[1416]  | -5208  | 192.5  | 2168 | S[1473]  | -5892  | 192.5  |
| 2055 | S[1360]  | -4536  | 282.5  | 2112 | S[1417]  | -5220  | 282.5  | 2169 | S[1474]  | -5904  | 282.5  |
| 2056 | S[1361]  | -4548  | 372.5  | 2113 | S[1418]  | -5232  | 372.5  | 2170 | S[1475]  | -5916  | 372.5  |
| 2057 | S[1362]  | -4560  | 192.5  | 2114 | S[1419]  | -5244  | 192.5  | 2171 | S[1476]  | -5928  | 192.5  |
| 2058 | S[1363]  | -4572  | 282.5  | 2115 | S[1420]  | -5256  | 282.5  | 2172 | S[1477]  | -5940  | 282.5  |
| 2059 | S[1364]  | -4584  | 372.5  | 2116 | S[1421]  | -5268  | 372.5  | 2173 | S[1478]  | -5952  | 372.5  |
| 2060 | S[1365]  | -4596  | 192.5  | 2117 | S[1422]  | -5280  | 192.5  | 2174 | S[1479]  | -5964  | 192.5  |
| 2061 | S[1366]  | -4608  | 282.5  | 2118 | S[1423]  | -5292  | 282.5  | 2175 | S[1480]  | -5976  | 282.5  |
| 2062 | S[1367]  | -4620  | 372.5  | 2119 | S[1424]  | -5304  | 372.5  | 2176 | S[1481]  | -5988  | 372.5  |
| 2063 | S[1368]  | -4632  | 192.5  | 2120 | S[1425]  | -5316  | 192.5  | 2177 | S[1482]  | -6000  | 192.5  |
| 2064 | S[1369]  | -4644  | 282.5  | 2121 | S[1426]  | -5328  | 282.5  | 2178 | S[1483]  | -6012  | 282.5  |
| 2065 | S[1370]  | -4656  | 372.5  | 2122 | S[1427]  | -5340  | 372.5  | 2179 | S[1484]  | -6024  | 372.5  |
| 2066 | S[1371]  | -4668  | 192.5  | 2123 | S[1428]  | -5352  | 192.5  | 2180 | S[1485]  | -6036  | 192.5  |
| 2067 | S[1372]  | -4680  | 282.5  | 2124 | S[1429]  | -5364  | 282.5  | 2181 | S[1486]  | -6048  | 282.5  |
| 2068 | S[1373]  | -4692  | 372.5  | 2125 | S[1430]  | -5376  | 372.5  | 2182 | S[1487]  | -6060  | 372.5  |
| 2069 | S[1374]  | -4704  | 192.5  | 2126 | S[1431]  | -5388  | 192.5  | 2183 | S[1488]  | -6072  | 192.5  |
| 2070 | S[1375]  | -4716  | 282.5  | 2127 | S[1432]  | -5400  | 282.5  | 2184 | S[1489]  | -6084  | 282.5  |
| 2071 | S[1376]  | -4728  | 372.5  | 2128 | S[1433]  | -5412  | 372.5  | 2185 | S[1490]  | -6096  | 372.5  |
| 2072 | S[1377]  | -4740  | 192.5  | 2129 | S[1434]  | -5424  | 192.5  | 2186 | S[1491]  | -6108  | 192.5  |
| 2073 | S[1378]  | -4752  | 282.5  | 2130 | S[1435]  | -5436  | 282.5  | 2187 | S[1492]  | -6120  | 282.5  |
| 2074 | S[1379]  | -4764  | 372.5  | 2131 | S[1436]  | -5448  | 372.5  | 2188 | S[1493]  | -6132  | 372.5  |
| 2075 | S[1380]  | -4776  | 192.5  | 2132 | S[1437]  | -5460  | 192.5  | 2189 | S[1494]  | -6144  | 192.5  |
| 2076 | S[1381]  | -4788  | 282.5  | 2133 | S[1438]  | -5472  | 282.5  | 2190 | S[1495]  | -6156  | 282.5  |
| 2077 | S[1382]  | -4800  | 372.5  | 2134 | S[1439]  | -5484  | 372.5  | 2191 | S[1496]  | -6168  | 372.5  |
| 2078 | S[1383]  | -4812  | 192.5  | 2135 | S[1440]  | -5496  | 192.5  | 2192 | S[1497]  | -6180  | 192.5  |
| 2079 | S[1384]  | -4824  | 282.5  | 2136 | S[1441]  | -5508  | 282.5  | 2193 | S[1498]  | -6192  | 282.5  |
| 2080 | S[1385]  | -4836  | 372.5  | 2137 | S[1442]  | -5520  | 372.5  | 2194 | S[1499]  | -6204  | 372.5  |
| 2081 | S[1386]  | -4848  | 192.5  | 2138 | S[1443]  | -5532  | 192.5  | 2195 | S[1500]  | -6216  | 192.5  |
| 2082 | S[1387]  | -4860  | 282.5  | 2139 | S[1444]  | -5544  | 282.5  | 2196 | S[1501]  | -6228  | 282.5  |
| 2083 | S[1388]  | -4872  | 372.5  | 2140 | S[1445]  | -5556  | 372.5  | 2197 | S[1502]  | -6240  | 372.5  |
| 2084 | S[1389]  | -4884  | 192.5  | 2141 | S[1446]  | -5568  | 192.5  | 2198 | S[1503]  | -6252  | 192.5  |
| 2085 | S[1390]  | -4896  | 282.5  | 2142 | S[1447]  | -5580  | 282.5  | 2199 | S[1504]  | -6264  | 282.5  |
| 2086 | S[1391]  | -4908  | 372.5  | 2143 | S[1448]  | -5592  | 372.5  | 2200 | S[1505]  | -6276  | 372.5  |
| 2087 | S[1392]  | -4920  | 192.5  | 2144 | S[1449]  | -5604  | 192.5  | 2201 | S[1506]  | -6288  | 192.5  |
| 2088 | S[1393]  | -4932  | 282.5  | 2145 | S[1450]  | -5616  | 282.5  | 2202 | S[1507]  | -6300  | 282.5  |
| 2089 | S[1394]  | -4944  | 372.5  | 2146 | S[1451]  | -5628  | 372.5  | 2203 | S[1508]  | -6312  | 372.5  |
| 2090 | S[1395]  | -4956  | 192.5  | 2147 | S[1452]  | -5640  | 192.5  | 2204 | S[1509]  | -6324  | 192.5  |
| 2091 | S[1396]  | -4968  | 282.5  | 2148 | S[1453]  | -5652  | 282.5  | 2205 | S[1510]  | -6336  | 282.5  |
| 2092 | S[1397]  | -4980  | 372.5  | 2149 | S[1454]  | -5664  | 372.5  | 2206 | S[1511]  | -6348  | 372.5  |
| 2093 | S[1398]  | -4992  | 192.5  | 2150 | S[1455]  | -5676  | 192.5  | 2207 | S[1512]  | -6360  | 192.5  |
| 2094 | S[1399]  | -5004  | 282.5  | 2151 | S[1456]  | -5688  | 282.5  | 2208 | S[1513]  | -6372  | 282.5  |
| 2095 | S[1400]  | -5016  | 372.5  | 2152 | S[1457]  | -5700  | 372.5  | 2209 | S[1514]  | -6384  | 372.5  |
| 2096 | S[1401]  | -5028  | 192.5  | 2153 | S[1458]  | -5712  | 192.5  | 2210 | S[1515]  | -6396  | 192.5  |
| 2097 | S[1402]  | -5040  | 282.5  | 2154 | S[1459]  | -5724  | 282.5  | 2211 | S[1516]  | -6408  | 282.5  |
| 2098 | S[1403]  | -5052  | 372.5  | 2155 | S[1460]  | -5736  | 372.5  | 2212 | S[1517]  | -6420  | 372.5  |
| 2099 | S[1404]  | -5064  | 192.5  | 2156 | S[1461]  | -5748  | 192.5  | 2213 | S[1518]  | -6432  | 192.5  |
| 2100 | S[1405]  | -5076  | 282.5  | 2157 | S[1462]  | -5760  | 282.5  | 2214 | S[1519]  | -6444  | 282.5  |
| 2101 | S[1406]  | -5088  | 372.5  | 2158 | S[1463]  | -5772  | 372.5  | 2215 | S[1520]  | -6456  | 372.5  |
| 2102 | S[1407]  | -5100  | 192.5  | 2159 | S[1464]  | -5784  | 192.5  | 2216 | S[1521]  | -6468  | 192.5  |
| 2103 | S[1408]  | -5112  | 282.5  | 2160 | S[1465]  | -5796  | 282.5  | 2217 | S[1522]  | -6480  | 282.5  |
| 2104 | S[1409]  | -5124  | 372.5  | 2161 | S[1466]  | -5808  | 372.5  | 2218 | S[1523]  | -6492  | 372.5  |
| 2105 | S[1410]  | -5136  | 192.5  | 2162 | S[1467]  | -5820  | 192.5  | 2219 | S[1524]  | -6504  | 192.5  |
| 2106 | S[1411]  | -5148  | 282.5  | 2163 | S[1468]  | -5832  | 282.5  | 2220 | S[1525]  | -6516  | 282.5  |
| 2107 | S[1412]  | -5160  | 372.5  | 2164 | S[1469]  | -5844  | 372.5  | 2221 | S[1526]  | -6528  | 372.5  |
| 2108 | S[1413]  | -5172  | 192.5  | 2165 | S[1470]  | -5856  | 192.5  | 2222 | S[1527]  | -6540  | 192.5  |
| 2109 | S[1414]  | -5184  | 282.5  | 2166 | S[1471]  | -5868  | 282.5  | 2223 | S[1528]  | -6552  | 282.5  |

| Pin  | Pad name   | X-axis | Y-axis | Pin  | Pad name | X-axis | Y-axis | Pin  | Pad name | X-axis | Y-axis |
|------|------------|--------|--------|------|----------|--------|--------|------|----------|--------|--------|
| 2224 | S[1529]    | -6564  | 372.5  | 2281 | S[1568]  | -7248  | 372.5  | 2338 | S[1625]  | -7932  | 372.5  |
| 2225 | S[1530]    | -6576  | 192.5  | 2282 | S[1569]  | -7260  | 192.5  | 2339 | S[1626]  | -7944  | 192.5  |
| 2226 | S[1531]    | -6588  | 282.5  | 2283 | S[1570]  | -7272  | 282.5  | 2340 | S[1627]  | -7956  | 282.5  |
| 2227 | S[1532]    | -6600  | 372.5  | 2284 | S[1571]  | -7284  | 372.5  | 2341 | S[1628]  | -7968  | 372.5  |
| 2228 | S[1533]    | -6612  | 192.5  | 2285 | S[1572]  | -7296  | 192.5  | 2342 | S[1629]  | -7980  | 192.5  |
| 2229 | S[1534]    | -6624  | 282.5  | 2286 | S[1573]  | -7308  | 282.5  | 2343 | S[1630]  | -7992  | 282.5  |
| 2230 | S[1535]    | -6636  | 372.5  | 2287 | S[1574]  | -7320  | 372.5  | 2344 | S[1631]  | -8004  | 372.5  |
| 2231 | S[1536]    | -6648  | 192.5  | 2288 | S[1575]  | -7332  | 192.5  | 2345 | S[1632]  | -8016  | 192.5  |
| 2232 | S[1537]    | -6660  | 282.5  | 2289 | S[1576]  | -7344  | 282.5  | 2346 | S[1633]  | -8028  | 282.5  |
| 2233 | S[1538]    | -6672  | 372.5  | 2290 | S[1577]  | -7356  | 372.5  | 2347 | S[1634]  | -8040  | 372.5  |
| 2234 | DUMMY[97]  | -6684  | 192.5  | 2291 | S[1578]  | -7368  | 192.5  | 2348 | S[1635]  | -8052  | 192.5  |
| 2235 | DUMMY[98]  | -6696  | 282.5  | 2292 | S[1579]  | -7380  | 282.5  | 2349 | S[1636]  | -8064  | 282.5  |
| 2236 | DUMMY[99]  | -6708  | 372.5  | 2293 | S[1580]  | -7392  | 372.5  | 2350 | S[1637]  | -8076  | 372.5  |
| 2237 | DUMMY[100] | -6720  | 192.5  | 2294 | S[1581]  | -7404  | 192.5  | 2351 | S[1638]  | -8088  | 192.5  |
| 2238 | DUMMY[101] | -6732  | 282.5  | 2295 | S[1582]  | -7416  | 282.5  | 2352 | S[1639]  | -8100  | 282.5  |
| 2239 | DUMMY[102] | -6744  | 372.5  | 2296 | S[1583]  | -7428  | 372.5  | 2353 | S[1640]  | -8112  | 372.5  |
| 2240 | DUMMY[103] | -6756  | 192.5  | 2297 | S[1584]  | -7440  | 192.5  | 2354 | S[1641]  | -8124  | 192.5  |
| 2241 | DUMMY[104] | -6768  | 282.5  | 2298 | S[1585]  | -7452  | 282.5  | 2355 | S[1642]  | -8136  | 282.5  |
| 2242 | DUMMY[105] | -6780  | 372.5  | 2299 | S[1586]  | -7464  | 372.5  | 2356 | S[1643]  | -8148  | 372.5  |
| 2243 | DUMMY[106] | -6792  | 192.5  | 2300 | S[1587]  | -7476  | 192.5  | 2357 | S[1644]  | -8160  | 192.5  |
| 2244 | DUMMY[107] | -6804  | 282.5  | 2301 | S[1588]  | -7488  | 282.5  | 2358 | S[1645]  | -8172  | 282.5  |
| 2245 | DUMMY[108] | -6816  | 372.5  | 2302 | S[1589]  | -7500  | 372.5  | 2359 | S[1646]  | -8184  | 372.5  |
| 2246 | DUMMY[109] | -6828  | 192.5  | 2303 | S[1590]  | -7512  | 192.5  | 2360 | S[1647]  | -8196  | 192.5  |
| 2247 | DUMMY[110] | -6840  | 282.5  | 2304 | S[1591]  | -7524  | 282.5  | 2361 | S[1648]  | -8208  | 282.5  |
| 2248 | DUMMY[111] | -6852  | 372.5  | 2305 | S[1592]  | -7536  | 372.5  | 2362 | S[1649]  | -8220  | 372.5  |
| 2249 | DUMMY[112] | -6864  | 192.5  | 2306 | S[1593]  | -7548  | 192.5  | 2363 | S[1650]  | -8232  | 192.5  |
| 2250 | DUMMY[113] | -6876  | 282.5  | 2307 | S[1594]  | -7560  | 282.5  | 2364 | S[1651]  | -8244  | 282.5  |
| 2251 | DUMMY[114] | -6888  | 372.5  | 2308 | S[1595]  | -7572  | 372.5  | 2365 | S[1652]  | -8256  | 372.5  |
| 2252 | S[1539]    | -6900  | 192.5  | 2309 | S[1596]  | -7584  | 192.5  | 2366 | S[1653]  | -8268  | 192.5  |
| 2253 | S[1540]    | -6912  | 282.5  | 2310 | S[1597]  | -7596  | 282.5  | 2367 | S[1654]  | -8280  | 282.5  |
| 2254 | S[1541]    | -6924  | 372.5  | 2311 | S[1598]  | -7608  | 372.5  | 2368 | S[1655]  | -8292  | 372.5  |
| 2255 | S[1542]    | -6936  | 192.5  | 2312 | S[1599]  | -7620  | 192.5  | 2369 | S[1656]  | -8304  | 192.5  |
| 2256 | S[1543]    | -6948  | 282.5  | 2313 | S[1600]  | -7632  | 282.5  | 2370 | S[1657]  | -8316  | 282.5  |
| 2257 | S[1544]    | -6960  | 372.5  | 2314 | S[1601]  | -7644  | 372.5  | 2371 | S[1658]  | -8328  | 372.5  |
| 2258 | S[1545]    | -6972  | 192.5  | 2315 | S[1602]  | -7656  | 192.5  | 2372 | S[1659]  | -8340  | 192.5  |
| 2259 | S[1546]    | -6984  | 282.5  | 2316 | S[1603]  | -7668  | 282.5  | 2373 | S[1660]  | -8352  | 282.5  |
| 2260 | S[1547]    | -6996  | 372.5  | 2317 | S[1604]  | -7680  | 372.5  | 2374 | S[1661]  | -8364  | 372.5  |
| 2261 | S[1548]    | -7008  | 192.5  | 2318 | S[1605]  | -7692  | 192.5  | 2375 | S[1662]  | -8376  | 192.5  |
| 2262 | S[1549]    | -7020  | 282.5  | 2319 | S[1606]  | -7704  | 282.5  | 2376 | S[1663]  | -8388  | 282.5  |
| 2263 | S[1550]    | -7032  | 372.5  | 2320 | S[1607]  | -7716  | 372.5  | 2377 | S[1664]  | -8400  | 372.5  |
| 2264 | S[1551]    | -7044  | 192.5  | 2321 | S[1608]  | -7728  | 192.5  | 2378 | S[1665]  | -8412  | 192.5  |
| 2265 | S[1552]    | -7056  | 282.5  | 2322 | S[1609]  | -7740  | 282.5  | 2379 | S[1666]  | -8424  | 282.5  |
| 2266 | S[1553]    | -7068  | 372.5  | 2323 | S[1610]  | -7752  | 372.5  | 2380 | S[1667]  | -8436  | 372.5  |
| 2267 | S[1554]    | -7080  | 192.5  | 2324 | S[1611]  | -7764  | 192.5  | 2381 | S[1668]  | -8448  | 192.5  |
| 2268 | S[1555]    | -7092  | 282.5  | 2325 | S[1612]  | -7776  | 282.5  | 2382 | S[1669]  | -8460  | 282.5  |
| 2269 | S[1556]    | -7104  | 372.5  | 2326 | S[1613]  | -7788  | 372.5  | 2383 | S[1670]  | -8472  | 372.5  |
| 2270 | S[1557]    | -7116  | 192.5  | 2327 | S[1614]  | -7800  | 192.5  | 2384 | S[1671]  | -8484  | 192.5  |
| 2271 | S[1558]    | -7128  | 282.5  | 2328 | S[1615]  | -7812  | 282.5  | 2385 | S[1672]  | -8496  | 282.5  |
| 2272 | S[1559]    | -7140  | 372.5  | 2329 | S[1616]  | -7824  | 372.5  | 2386 | S[1673]  | -8508  | 372.5  |
| 2273 | S[1560]    | -7152  | 192.5  | 2330 | S[1617]  | -7836  | 192.5  | 2387 | S[1674]  | -8520  | 192.5  |
| 2274 | S[1561]    | -7164  | 282.5  | 2331 | S[1618]  | -7848  | 282.5  | 2388 | S[1675]  | -8532  | 282.5  |
| 2275 | S[1562]    | -7176  | 372.5  | 2332 | S[1619]  | -7860  | 372.5  | 2389 | S[1676]  | -8544  | 372.5  |
| 2276 | S[1563]    | -7188  | 192.5  | 2333 | S[1620]  | -7872  | 192.5  | 2390 | S[1677]  | -8556  | 192.5  |
| 2277 | S[1564]    | -7200  | 282.5  | 2334 | S[1621]  | -7884  | 282.5  | 2391 | S[1678]  | -8568  | 282.5  |
| 2278 | S[1565]    | -7212  | 372.5  | 2335 | S[1622]  | -7896  | 372.5  | 2392 | S[1679]  | -8580  | 372.5  |
| 2279 | S[1566]    | -7224  | 192.5  | 2336 | S[1623]  | -7908  | 192.5  | 2393 | S[1680]  | -8592  | 192.5  |
| 2280 | S[1567]    | -7236  | 282.5  | 2337 | S[1624]  | -7920  | 282.5  | 2394 | S[1681]  | -8604  | 282.5  |

| Pin  | Pad name | X-axis | Y-axis | Pin  | Pad name | X-axis | Y-axis | Pin  | Pad name | X-axis | Y-axis |
|------|----------|--------|--------|------|----------|--------|--------|------|----------|--------|--------|
| 2395 | S[1682]  | -8616  | 372.5  | 2452 | S[1739]  | -9300  | 372.5  | 2509 | S[1796]  | -9984  | 372.5  |
| 2396 | S[1683]  | -8628  | 192.5  | 2453 | S[1740]  | -9312  | 192.5  | 2510 | S[1797]  | -9996  | 192.5  |
| 2397 | S[1684]  | -8640  | 282.5  | 2454 | S[1741]  | -9324  | 282.5  | 2511 | S[1798]  | -10008 | 282.5  |
| 2398 | S[1685]  | -8652  | 372.5  | 2455 | S[1742]  | -9336  | 372.5  | 2512 | S[1799]  | -10020 | 372.5  |
| 2399 | S[1686]  | -8664  | 192.5  | 2456 | S[1743]  | -9348  | 192.5  | 2513 | S[1800]  | -10032 | 192.5  |
| 2400 | S[1687]  | -8676  | 282.5  | 2457 | S[1744]  | -9360  | 282.5  | 2514 | S[1801]  | -10044 | 282.5  |
| 2401 | S[1688]  | -8688  | 372.5  | 2458 | S[1745]  | -9372  | 372.5  | 2515 | S[1802]  | -10056 | 372.5  |
| 2402 | S[1689]  | -8700  | 192.5  | 2459 | S[1746]  | -9384  | 192.5  | 2516 | S[1803]  | -10068 | 192.5  |
| 2403 | S[1690]  | -8712  | 282.5  | 2460 | S[1747]  | -9396  | 282.5  | 2517 | S[1804]  | -10080 | 282.5  |
| 2404 | S[1691]  | -8724  | 372.5  | 2461 | S[1748]  | -9408  | 372.5  | 2518 | S[1805]  | -10092 | 372.5  |
| 2405 | S[1692]  | -8736  | 192.5  | 2462 | S[1749]  | -9420  | 192.5  | 2519 | S[1806]  | -10104 | 192.5  |
| 2406 | S[1693]  | -8748  | 282.5  | 2463 | S[1750]  | -9432  | 282.5  | 2520 | S[1807]  | -10116 | 282.5  |
| 2407 | S[1694]  | -8760  | 372.5  | 2464 | S[1751]  | -9444  | 372.5  | 2521 | S[1808]  | -10128 | 372.5  |
| 2408 | S[1695]  | -8772  | 192.5  | 2465 | S[1752]  | -9456  | 192.5  | 2522 | S[1809]  | -10140 | 192.5  |
| 2409 | S[1696]  | -8784  | 282.5  | 2466 | S[1753]  | -9468  | 282.5  | 2523 | S[1810]  | -10152 | 282.5  |
| 2410 | S[1697]  | -8796  | 372.5  | 2467 | S[1754]  | -9480  | 372.5  | 2524 | S[1811]  | -10164 | 372.5  |
| 2411 | S[1698]  | -8808  | 192.5  | 2468 | S[1755]  | -9492  | 192.5  | 2525 | S[1812]  | -10176 | 192.5  |
| 2412 | S[1699]  | -8820  | 282.5  | 2469 | S[1756]  | -9504  | 282.5  | 2526 | S[1813]  | -10188 | 282.5  |
| 2413 | S[1700]  | -8832  | 372.5  | 2470 | S[1757]  | -9516  | 372.5  | 2527 | S[1814]  | -10200 | 372.5  |
| 2414 | S[1701]  | -8844  | 192.5  | 2471 | S[1758]  | -9528  | 192.5  | 2528 | S[1815]  | -10212 | 192.5  |
| 2415 | S[1702]  | -8856  | 282.5  | 2472 | S[1759]  | -9540  | 282.5  | 2529 | S[1816]  | -10224 | 282.5  |
| 2416 | S[1703]  | -8868  | 372.5  | 2473 | S[1760]  | -9552  | 372.5  | 2530 | S[1817]  | -10236 | 372.5  |
| 2417 | S[1704]  | -8880  | 192.5  | 2474 | S[1761]  | -9564  | 192.5  | 2531 | S[1818]  | -10248 | 192.5  |
| 2418 | S[1705]  | -8892  | 282.5  | 2475 | S[1762]  | -9576  | 282.5  | 2532 | S[1819]  | -10260 | 282.5  |
| 2419 | S[1706]  | -8904  | 372.5  | 2476 | S[1763]  | -9588  | 372.5  | 2533 | S[1820]  | -10272 | 372.5  |
| 2420 | S[1707]  | -8916  | 192.5  | 2477 | S[1764]  | -9600  | 192.5  | 2534 | S[1821]  | -10284 | 192.5  |
| 2421 | S[1708]  | -8928  | 282.5  | 2478 | S[1765]  | -9612  | 282.5  | 2535 | S[1822]  | -10296 | 282.5  |
| 2422 | S[1709]  | -8940  | 372.5  | 2479 | S[1766]  | -9624  | 372.5  | 2536 | S[1823]  | -10308 | 372.5  |
| 2423 | S[1710]  | -8952  | 192.5  | 2480 | S[1767]  | -9636  | 192.5  | 2537 | S[1824]  | -10320 | 192.5  |
| 2424 | S[1711]  | -8964  | 282.5  | 2481 | S[1768]  | -9648  | 282.5  | 2538 | S[1825]  | -10332 | 282.5  |
| 2425 | S[1712]  | -8976  | 372.5  | 2482 | S[1769]  | -9660  | 372.5  | 2539 | S[1826]  | -10344 | 372.5  |
| 2426 | S[1713]  | -8988  | 192.5  | 2483 | S[1770]  | -9672  | 192.5  | 2540 | S[1827]  | -10356 | 192.5  |
| 2427 | S[1714]  | -9000  | 282.5  | 2484 | S[1771]  | -9684  | 282.5  | 2541 | S[1828]  | -10368 | 282.5  |
| 2428 | S[1715]  | -9012  | 372.5  | 2485 | S[1772]  | -9696  | 372.5  | 2542 | S[1829]  | -10380 | 372.5  |
| 2429 | S[1716]  | -9024  | 192.5  | 2486 | S[1773]  | -9708  | 192.5  | 2543 | S[1830]  | -10392 | 192.5  |
| 2430 | S[1717]  | -9036  | 282.5  | 2487 | S[1774]  | -9720  | 282.5  | 2544 | S[1831]  | -10404 | 282.5  |
| 2431 | S[1718]  | -9048  | 372.5  | 2488 | S[1775]  | -9732  | 372.5  | 2545 | S[1832]  | -10416 | 372.5  |
| 2432 | S[1719]  | -9060  | 192.5  | 2489 | S[1776]  | -9744  | 192.5  | 2546 | S[1833]  | -10428 | 192.5  |
| 2433 | S[1720]  | -9072  | 282.5  | 2490 | S[1777]  | -9756  | 282.5  | 2547 | S[1834]  | -10440 | 282.5  |
| 2434 | S[1721]  | -9084  | 372.5  | 2491 | S[1778]  | -9768  | 372.5  | 2548 | S[1835]  | -10452 | 372.5  |
| 2435 | S[1722]  | -9096  | 192.5  | 2492 | S[1779]  | -9780  | 192.5  | 2549 | S[1836]  | -10464 | 192.5  |
| 2436 | S[1723]  | -9108  | 282.5  | 2493 | S[1780]  | -9792  | 282.5  | 2550 | S[1837]  | -10476 | 282.5  |
| 2437 | S[1724]  | -9120  | 372.5  | 2494 | S[1781]  | -9804  | 372.5  | 2551 | S[1838]  | -10488 | 372.5  |
| 2438 | S[1725]  | -9132  | 192.5  | 2495 | S[1782]  | -9816  | 192.5  | 2552 | S[1839]  | -10500 | 192.5  |
| 2439 | S[1726]  | -9144  | 282.5  | 2496 | S[1783]  | -9828  | 282.5  | 2553 | S[1840]  | -10512 | 282.5  |
| 2440 | S[1727]  | -9156  | 372.5  | 2497 | S[1784]  | -9840  | 372.5  | 2554 | S[1841]  | -10524 | 372.5  |
| 2441 | S[1728]  | -9168  | 192.5  | 2498 | S[1785]  | -9852  | 192.5  | 2555 | S[1842]  | -10536 | 192.5  |
| 2442 | S[1729]  | -9180  | 282.5  | 2499 | S[1786]  | -9864  | 282.5  | 2556 | S[1843]  | -10548 | 282.5  |
| 2443 | S[1730]  | -9192  | 372.5  | 2500 | S[1787]  | -9876  | 372.5  | 2557 | S[1844]  | -10560 | 372.5  |
| 2444 | S[1731]  | -9204  | 192.5  | 2501 | S[1788]  | -9888  | 192.5  | 2558 | S[1845]  | -10572 | 192.5  |
| 2445 | S[1732]  | -9216  | 282.5  | 2502 | S[1789]  | -9900  | 282.5  | 2559 | S[1846]  | -10584 | 282.5  |
| 2446 | S[1733]  | -9228  | 372.5  | 2503 | S[1790]  | -9912  | 372.5  | 2560 | S[1847]  | -10596 | 372.5  |
| 2447 | S[1734]  | -9240  | 192.5  | 2504 | S[1791]  | -9924  | 192.5  | 2561 | S[1848]  | -10608 | 192.5  |
| 2448 | S[1735]  | -9252  | 282.5  | 2505 | S[1792]  | -9936  | 282.5  | 2562 | S[1849]  | -10620 | 282.5  |
| 2449 | S[1736]  | -9264  | 372.5  | 2506 | S[1793]  | -9948  | 372.5  | 2563 | S[1850]  | -10632 | 372.5  |
| 2450 | S[1737]  | -9276  | 192.5  | 2507 | S[1794]  | -9960  | 192.5  | 2564 | S[1851]  | -10644 | 192.5  |
| 2451 | S[1738]  | -9288  | 282.5  | 2508 | S[1795]  | -9972  | 282.5  | 2565 | S[1852]  | -10656 | 282.5  |

| Pin  | Pad name | X-axis | Y-axis | Pin  | Pad name | X-axis | Y-axis | Pin  | Pad name | X-axis | Y-axis |
|------|----------|--------|--------|------|----------|--------|--------|------|----------|--------|--------|
| 2566 | S[1853]  | -10668 | 372.5  | 2623 | S[1910]  | -11352 | 372.5  | 2680 | S[1967]  | -12036 | 372.5  |
| 2567 | S[1854]  | -10680 | 192.5  | 2624 | S[1911]  | -11364 | 192.5  | 2681 | S[1968]  | -12048 | 192.5  |
| 2568 | S[1855]  | -10692 | 282.5  | 2625 | S[1912]  | -11376 | 282.5  | 2682 | S[1969]  | -12060 | 282.5  |
| 2569 | S[1856]  | -10704 | 372.5  | 2626 | S[1913]  | -11388 | 372.5  | 2683 | S[1970]  | -12072 | 372.5  |
| 2570 | S[1857]  | -10716 | 192.5  | 2627 | S[1914]  | -11400 | 192.5  | 2684 | S[1971]  | -12084 | 192.5  |
| 2571 | S[1858]  | -10728 | 282.5  | 2628 | S[1915]  | -11412 | 282.5  | 2685 | S[1972]  | -12096 | 282.5  |
| 2572 | S[1859]  | -10740 | 372.5  | 2629 | S[1916]  | -11424 | 372.5  | 2686 | S[1973]  | -12108 | 372.5  |
| 2573 | S[1860]  | -10752 | 192.5  | 2630 | S[1917]  | -11436 | 192.5  | 2687 | S[1974]  | -12120 | 192.5  |
| 2574 | S[1861]  | -10764 | 282.5  | 2631 | S[1918]  | -11448 | 282.5  | 2688 | S[1975]  | -12132 | 282.5  |
| 2575 | S[1862]  | -10776 | 372.5  | 2632 | S[1919]  | -11460 | 372.5  | 2689 | S[1976]  | -12144 | 372.5  |
| 2576 | S[1863]  | -10788 | 192.5  | 2633 | S[1920]  | -11472 | 192.5  | 2690 | S[1977]  | -12156 | 192.5  |
| 2577 | S[1864]  | -10800 | 282.5  | 2634 | S[1921]  | -11484 | 282.5  | 2691 | S[1978]  | -12168 | 282.5  |
| 2578 | S[1865]  | -10812 | 372.5  | 2635 | S[1922]  | -11496 | 372.5  | 2692 | S[1979]  | -12180 | 372.5  |
| 2579 | S[1866]  | -10824 | 192.5  | 2636 | S[1923]  | -11508 | 192.5  | 2693 | S[1980]  | -12192 | 192.5  |
| 2580 | S[1867]  | -10836 | 282.5  | 2637 | S[1924]  | -11520 | 282.5  | 2694 | S[1981]  | -12204 | 282.5  |
| 2581 | S[1868]  | -10848 | 372.5  | 2638 | S[1925]  | -11532 | 372.5  | 2695 | S[1982]  | -12216 | 372.5  |
| 2582 | S[1869]  | -10860 | 192.5  | 2639 | S[1926]  | -11544 | 192.5  | 2696 | S[1983]  | -12228 | 192.5  |
| 2583 | S[1870]  | -10872 | 282.5  | 2640 | S[1927]  | -11556 | 282.5  | 2697 | S[1984]  | -12240 | 282.5  |
| 2584 | S[1871]  | -10884 | 372.5  | 2641 | S[1928]  | -11568 | 372.5  | 2698 | S[1985]  | -12252 | 372.5  |
| 2585 | S[1872]  | -10896 | 192.5  | 2642 | S[1929]  | -11580 | 192.5  | 2699 | S[1986]  | -12264 | 192.5  |
| 2586 | S[1873]  | -10908 | 282.5  | 2643 | S[1930]  | -11592 | 282.5  | 2700 | S[1987]  | -12276 | 282.5  |
| 2587 | S[1874]  | -10920 | 372.5  | 2644 | S[1931]  | -11604 | 372.5  | 2701 | S[1988]  | -12288 | 372.5  |
| 2588 | S[1875]  | -10932 | 192.5  | 2645 | S[1932]  | -11616 | 192.5  | 2702 | S[1989]  | -12300 | 192.5  |
| 2589 | S[1876]  | -10944 | 282.5  | 2646 | S[1933]  | -11628 | 282.5  | 2703 | S[1990]  | -12312 | 282.5  |
| 2590 | S[1877]  | -10956 | 372.5  | 2647 | S[1934]  | -11640 | 372.5  | 2704 | S[1991]  | -12324 | 372.5  |
| 2591 | S[1878]  | -10968 | 192.5  | 2648 | S[1935]  | -11652 | 192.5  | 2705 | S[1992]  | -12336 | 192.5  |
| 2592 | S[1879]  | -10980 | 282.5  | 2649 | S[1936]  | -11664 | 282.5  | 2706 | S[1993]  | -12348 | 282.5  |
| 2593 | S[1880]  | -10992 | 372.5  | 2650 | S[1937]  | -11676 | 372.5  | 2707 | S[1994]  | -12360 | 372.5  |
| 2594 | S[1881]  | -11004 | 192.5  | 2651 | S[1938]  | -11688 | 192.5  | 2708 | S[1995]  | -12372 | 192.5  |
| 2595 | S[1882]  | -11016 | 282.5  | 2652 | S[1939]  | -11700 | 282.5  | 2709 | S[1996]  | -12384 | 282.5  |
| 2596 | S[1883]  | -11028 | 372.5  | 2653 | S[1940]  | -11712 | 372.5  | 2710 | S[1997]  | -12396 | 372.5  |
| 2597 | S[1884]  | -11040 | 192.5  | 2654 | S[1941]  | -11724 | 192.5  | 2711 | S[1998]  | -12408 | 192.5  |
| 2598 | S[1885]  | -11052 | 282.5  | 2655 | S[1942]  | -11736 | 282.5  | 2712 | S[1999]  | -12420 | 282.5  |
| 2599 | S[1886]  | -11064 | 372.5  | 2656 | S[1943]  | -11748 | 372.5  | 2713 | S[2000]  | -12432 | 372.5  |
| 2600 | S[1887]  | -11076 | 192.5  | 2657 | S[1944]  | -11760 | 192.5  | 2714 | S[2001]  | -12444 | 192.5  |
| 2601 | S[1888]  | -11088 | 282.5  | 2658 | S[1945]  | -11772 | 282.5  | 2715 | S[2002]  | -12456 | 282.5  |
| 2602 | S[1889]  | -11100 | 372.5  | 2659 | S[1946]  | -11784 | 372.5  | 2716 | S[2003]  | -12468 | 372.5  |
| 2603 | S[1890]  | -11112 | 192.5  | 2660 | S[1947]  | -11796 | 192.5  | 2717 | S[2004]  | -12480 | 192.5  |
| 2604 | S[1891]  | -11124 | 282.5  | 2661 | S[1948]  | -11808 | 282.5  | 2718 | S[2005]  | -12492 | 282.5  |
| 2605 | S[1892]  | -11136 | 372.5  | 2662 | S[1949]  | -11820 | 372.5  | 2719 | S[2006]  | -12504 | 372.5  |
| 2606 | S[1893]  | -11148 | 192.5  | 2663 | S[1950]  | -11832 | 192.5  | 2720 | S[2007]  | -12516 | 192.5  |
| 2607 | S[1894]  | -11160 | 282.5  | 2664 | S[1951]  | -11844 | 282.5  | 2721 | S[2008]  | -12528 | 282.5  |
| 2608 | S[1895]  | -11172 | 372.5  | 2665 | S[1952]  | -11856 | 372.5  | 2722 | S[2009]  | -12540 | 372.5  |
| 2609 | S[1896]  | -11184 | 192.5  | 2666 | S[1953]  | -11868 | 192.5  | 2723 | S[2010]  | -12552 | 192.5  |
| 2610 | S[1897]  | -11196 | 282.5  | 2667 | S[1954]  | -11880 | 282.5  | 2724 | S[2011]  | -12564 | 282.5  |
| 2611 | S[1898]  | -11208 | 372.5  | 2668 | S[1955]  | -11892 | 372.5  | 2725 | S[2012]  | -12576 | 372.5  |
| 2612 | S[1899]  | -11220 | 192.5  | 2669 | S[1956]  | -11904 | 192.5  | 2726 | S[2013]  | -12588 | 192.5  |
| 2613 | S[1900]  | -11232 | 282.5  | 2670 | S[1957]  | -11916 | 282.5  | 2727 | S[2014]  | -12600 | 282.5  |
| 2614 | S[1901]  | -11244 | 372.5  | 2671 | S[1958]  | -11928 | 372.5  | 2728 | S[2015]  | -12612 | 372.5  |
| 2615 | S[1902]  | -11256 | 192.5  | 2672 | S[1959]  | -11940 | 192.5  | 2729 | S[2016]  | -12624 | 192.5  |
| 2616 | S[1903]  | -11268 | 282.5  | 2673 | S[1960]  | -11952 | 282.5  | 2730 | S[2017]  | -12636 | 282.5  |
| 2617 | S[1904]  | -11280 | 372.5  | 2674 | S[1961]  | -11964 | 372.5  | 2731 | S[2018]  | -12648 | 372.5  |
| 2618 | S[1905]  | -11292 | 192.5  | 2675 | S[1962]  | -11976 | 192.5  | 2732 | S[2019]  | -12660 | 192.5  |
| 2619 | S[1906]  | -11304 | 282.5  | 2676 | S[1963]  | -11988 | 282.5  | 2733 | S[2020]  | -12672 | 282.5  |
| 2620 | S[1907]  | -11316 | 372.5  | 2677 | S[1964]  | -12000 | 372.5  | 2734 | S[2021]  | -12684 | 372.5  |
| 2621 | S[1908]  | -11328 | 192.5  | 2678 | S[1965]  | -12012 | 192.5  | 2735 | S[2022]  | -12696 | 192.5  |
| 2622 | S[1909]  | -11340 | 282.5  | 2679 | S[1966]  | -12024 | 282.5  | 2736 | S[2023]  | -12708 | 282.5  |

| Pin  | Pad name   | X-axis | Y-axis | Pin  | Pad name   | X-axis | Y-axis | Pin | Pad name | X-axis | Y-axis |
|------|------------|--------|--------|------|------------|--------|--------|-----|----------|--------|--------|
| 2737 | S[2024]    | -12720 | 372.5  | 2794 | DUMMY[126] | -13404 | 372.5  |     |          |        |        |
| 2738 | S[2025]    | -12732 | 192.5  | 2795 | DUMMY[127] | -13416 | 192.5  |     |          |        |        |
| 2739 | S[2026]    | -12744 | 282.5  | 2796 | DUMMY[128] | -13428 | 282.5  |     |          |        |        |
| 2740 | S[2027]    | -12756 | 372.5  | 2797 | DUMMY[129] | -13440 | 372.5  |     |          |        |        |
| 2741 | S[2028]    | -12768 | 192.5  |      |            |        |        |     |          |        |        |
| 2742 | S[2029]    | -12780 | 282.5  |      |            |        |        |     |          |        |        |
| 2743 | S[2030]    | -12792 | 372.5  |      |            |        |        |     |          |        |        |
| 2744 | S[2031]    | -12804 | 192.5  |      |            |        |        |     |          |        |        |
| 2745 | S[2032]    | -12816 | 282.5  |      |            |        |        |     |          |        |        |
| 2746 | S[2033]    | -12828 | 372.5  |      |            |        |        |     |          |        |        |
| 2747 | S[2034]    | -12840 | 192.5  |      |            |        |        |     |          |        |        |
| 2748 | S[2035]    | -12852 | 282.5  |      |            |        |        |     |          |        |        |
| 2749 | S[2036]    | -12864 | 372.5  |      |            |        |        |     |          |        |        |
| 2750 | S[2037]    | -12876 | 192.5  |      |            |        |        |     |          |        |        |
| 2751 | S[2038]    | -12888 | 282.5  |      |            |        |        |     |          |        |        |
| 2752 | S[2039]    | -12900 | 372.5  |      |            |        |        |     |          |        |        |
| 2753 | S[2040]    | -12912 | 192.5  |      |            |        |        |     |          |        |        |
| 2754 | S[2041]    | -12924 | 282.5  |      |            |        |        |     |          |        |        |
| 2755 | S[2042]    | -12936 | 372.5  |      |            |        |        |     |          |        |        |
| 2756 | S[2043]    | -12948 | 192.5  |      |            |        |        |     |          |        |        |
| 2757 | S[2044]    | -12960 | 282.5  |      |            |        |        |     |          |        |        |
| 2758 | S[2045]    | -12972 | 372.5  |      |            |        |        |     |          |        |        |
| 2759 | S[2046]    | -12984 | 192.5  |      |            |        |        |     |          |        |        |
| 2760 | S[2047]    | -12996 | 282.5  |      |            |        |        |     |          |        |        |
| 2761 | S[2048]    | -13008 | 372.5  |      |            |        |        |     |          |        |        |
| 2762 | S[2049]    | -13020 | 192.5  |      |            |        |        |     |          |        |        |
| 2763 | S[2050]    | -13032 | 282.5  |      |            |        |        |     |          |        |        |
| 2764 | S[2051]    | -13044 | 372.5  |      |            |        |        |     |          |        |        |
| 2765 | DUMMY[115] | -13056 | 192.5  |      |            |        |        |     |          |        |        |
| 2766 | DUMMY[116] | -13068 | 282.5  |      |            |        |        |     |          |        |        |
| 2767 | DUMMY[117] | -13080 | 372.5  |      |            |        |        |     |          |        |        |
| 2768 | DUMMY[118] | -13092 | 192.5  |      |            |        |        |     |          |        |        |
| 2769 | DUMMY[119] | -13104 | 282.5  |      |            |        |        |     |          |        |        |
| 2770 | DUMMY[120] | -13116 | 372.5  |      |            |        |        |     |          |        |        |
| 2771 | PASS2_R    | -13128 | 192.5  |      |            |        |        |     |          |        |        |
| 2772 | PASS2_R    | -13140 | 282.5  |      |            |        |        |     |          |        |        |
| 2773 | PASS2_R    | -13152 | 372.5  |      |            |        |        |     |          |        |        |
| 2774 | PASS2_R    | -13164 | 192.5  |      |            |        |        |     |          |        |        |
| 2775 | PASS2_R    | -13176 | 282.5  |      |            |        |        |     |          |        |        |
| 2776 | PASS2_R    | -13188 | 372.5  |      |            |        |        |     |          |        |        |
| 2777 | VCOM       | -13200 | 192.5  |      |            |        |        |     |          |        |        |
| 2778 | VCOM       | -13212 | 282.5  |      |            |        |        |     |          |        |        |
| 2779 | VCOM       | -13224 | 372.5  |      |            |        |        |     |          |        |        |
| 2780 | VCOM       | -13236 | 192.5  |      |            |        |        |     |          |        |        |
| 2781 | VCOM       | -13248 | 282.5  |      |            |        |        |     |          |        |        |
| 2782 | VCOM       | -13260 | 372.5  |      |            |        |        |     |          |        |        |
| 2783 | PASS1_R    | -13272 | 192.5  |      |            |        |        |     |          |        |        |
| 2784 | PASS1_R    | -13284 | 282.5  |      |            |        |        |     |          |        |        |
| 2785 | PASS1_R    | -13296 | 372.5  |      |            |        |        |     |          |        |        |
| 2786 | PASS1_R    | -13308 | 192.5  |      |            |        |        |     |          |        |        |
| 2787 | PASS1_R    | -13320 | 282.5  |      |            |        |        |     |          |        |        |
| 2788 | PASS1_R    | -13332 | 372.5  |      |            |        |        |     |          |        |        |
| 2789 | DUMMY[121] | -13344 | 192.5  |      |            |        |        |     |          |        |        |
| 2790 | DUMMY[122] | -13356 | 282.5  |      |            |        |        |     |          |        |        |
| 2791 | DUMMY[123] | -13368 | 372.5  |      |            |        |        |     |          |        |        |
| 2792 | DUMMY[124] | -13380 | 192.5  |      |            |        |        |     |          |        |        |
| 2793 | DUMMY[125] | -13392 | 282.5  |      |            |        |        |     |          |        |        |

## 16. REVISION HISTORY

| Revision | Content                                                                                              | Page                  | Date       |
|----------|------------------------------------------------------------------------------------------------------|-----------------------|------------|
| 0.1      | New SPEC For BA                                                                                      | -                     | 2019/08/26 |
| 0.2      | Modify Pin UPDN define                                                                               | -                     | 2019/11/26 |
| 0.3      | Add Normal Dual gate & GOA Application description                                                   | P16                   | 2019/12/11 |
| 0.4      | Modify DIR description                                                                               | P17                   | 2020/06/18 |
| 0.5      | Add LVDS DC electrical characteristics descript<br>Add LVDS DE mode timing table<br>DE/SYNC waveform | P44<br>P29-P30<br>P32 | 2020/07/09 |
| 0.6      | Add LVDS signal characteristics                                                                      | P44                   | 2020/07/13 |
| 0.7      | Modify LVDS signal characteristics                                                                   | P44                   | 2020/07/16 |
| 0.8      | Modify LVDS DC electrical characteristics                                                            | P43                   | 2020/07/20 |
| 0.9      | Modify operating temperature value                                                                   | -                     | 2023/01/10 |
| 1.0      | Add Dual Gate+Zigzag Driving<br>Add Input Timing Table 1280X720<br>Modify Power on/pff sequence      | 8<br>32<br>36.37      | 2023/03/21 |
| 1.1      | Modify LNSW define                                                                                   | 18                    | 2023/04/06 |

FITIPOWER CONFIDENTIAL  
NO DISCLOSURE